

**UNITED STATES
SECURITIES AND EXCHANGE COMMISSION**
Washington, D.C. 20549

FORM 8-K

CURRENT REPORT
Pursuant to Section 13 or Section 15(d)
of the Securities Exchange Act of 1934

Date of Report (Date of earliest event reported): December 20, 2021 (December 19, 2021)

DYNAMICS SPECIAL PURPOSE CORP.

(Exact name of registrant as specified in its charter)

Delaware
(State or other jurisdiction of
incorporation or organization)

001-40440
(Commission
File Number)

86-2437900
(IRS Employer
Identification Number)

2875 El Camino Real
Redwood City, CA 94061
(Address of principal executive offices)

(408) 212-0200
Registrant's telephone number, including area code

Not Applicable
(Former name or former address, if changed since last report)

Check the appropriate box below if the Form 8-K filing is intended to simultaneously satisfy the filing obligation of the registrant under any of the following provisions:

- Written communications pursuant to Rule 425 under the Securities Act (17 CFR 230.425)
- Soliciting material pursuant to Rule 14a-12 under the Exchange Act (17 CFR 240.14a-12)
- Pre-commencement communications pursuant to Rule 14d-2(b) under the Exchange Act (17 CFR 240.14d-2(b))
- Pre-commencement communications pursuant to Rule 13e-4(c) under the Exchange Act (17 CFR 240.13e-4(c))

Securities registered pursuant to Section 12(b) of the Act:

Title of each class	Trading Symbol(s)	Name of each exchange on which registered
Class A common stock, par value \$0.0001 per share	DYNS	Nasdaq Capital Market

Indicate by check mark whether the registrant is an emerging growth company as defined in Rule 405 of the Securities Act of 1933 or Rule 12b-2 of the Securities Exchange Act of 1934.

Emerging growth company

If an emerging growth company, indicate by check mark if the registrant has elected not to use the extended transition period for complying with any new or revised financial accounting standards provided pursuant to Section 13(a) of the Exchange Act.

Item 1.01 Entry into a Material Definitive Agreement.

Business Combination Agreement

On December 19, 2021, Dynamics Special Purpose Corp., a Delaware corporation (the “**Company**”), entered into a business combination agreement (the “**Business Combination Agreement**”) by and among the Company, Explore Merger Sub, Inc., a Delaware corporation (“**Merger Sub**”), and Senti Biosciences, Inc., a Delaware corporation (“**Senti**”). The Business Combination Agreement provides, among other things, that on the terms and subject to the conditions set forth therein, Merger Sub will merge with and into Senti, with Senti surviving as a wholly-owned subsidiary of the Company (the “**Merger**”). Upon the closing of the Merger (the “**Closing**”), the Company will change its name to “Senti Biosciences Inc.” The date on which the closing of the merger (the “**Closing**”) actually occurs is hereinafter referred to as the “**Closing Date**.”

The Business Combination Agreement and the transactions contemplated thereby were approved by the boards of directors of each of the Company and Senti.

Consideration and Structure

Under the Business Combination Agreement, the Company will acquire all of the outstanding equity interests of Senti in exchange for shares of the Company’s Class A common stock, par value \$0.0001 per share (the “**Class A Common Stock**”), based on an implied Senti equity value of \$240,000,000, to be paid to Senti stockholders at the effective time of the Merger. In addition, Senti stockholders will have the right to receive (i) an aggregate of 1,000,000 shares of Class A Common Stock if, after Closing, the volume weighted average price (“**VWAP**”) of the Class A Common Stock on the Nasdaq Capital Market (“**Nasdaq**”), or any other national securities exchange on which the shares of Class A Common Stock are then traded, is greater than or equal to \$15.00 over any 20 trading days within any consecutive 30 trading day period, in the period that ends on the second anniversary of the Closing, and (ii) an additional 1,000,000 shares of Class A Common Stock in the aggregate if, after Closing, the VWAP of Class A Common Stock on Nasdaq, or any other national securities exchange on which the shares of Class A Common Stock are then traded, is greater than or equal to \$20.00 over any 20 trading days within any consecutive 30 trading day period, in the period that ends on the third anniversary of the Closing.

Pursuant to the Business Combination Agreement, at or prior to the effective time of the Merger, each option exercisable for Senti equity that is outstanding immediately prior to the effective time of the Merger shall be assumed by the Company and continue in full force and effect on the same terms and conditions as are currently applicable to such options, subject to adjustments to exercise price and number of shares of Class A Common Stock issued upon exercise.

Representations, Warranties and Covenants

The parties to the Business Combination Agreement have agreed to customary representations and warranties for transactions of this type. In addition, the parties to the Business Combination Agreement agreed to be bound by certain customary covenants for transactions of this type, including, among others, covenants with respect to the conduct of Senti, the Company and their respective subsidiaries during the period between execution of the Business Combination Agreement and Closing. The representations, warranties, agreements and covenants of the parties set forth in the Business Combination Agreement will terminate at Closing, except for those covenants and agreements that, by their terms, contemplate performance after Closing. Each of the parties to the Business Combination Agreement has agreed to use its reasonable best efforts to take or cause to be taken all actions and things necessary to consummate and expeditiously implement the Merger.

Conditions to Closing

Under the Business Combination Agreement, the obligations of the parties to consummate the Merger are subject to the satisfaction or waiver of certain customary closing conditions of the respective parties, including, without limitation: (i) the approval and adoption of the Business Combination Agreement and transactions contemplated thereby by requisite vote of the Company’s stockholders (the “**Company Stockholder Approval**”) and Senti’s stockholders (the “**Senti Stockholder Approval**”); (ii) the expiration or termination of the applicable waiting period under the Hart-Scott-Rodino Antitrust Improvements Act of 1976, as amended; (iii) the absence of a Company Material Adverse Effect or DYNs Material Adverse Effect (each, as defined in the Business Combination Agreement) since the date of the Business Combination Agreement that is continuing; (iv) after giving effect to the transactions contemplated by the Business Combination Agreement, the Company has net tangible assets of at least \$5,000,001 upon consummation of the Merger; (v) the Company’s initial listing application with Nasdaq in connection with the Merger has been approved and, immediately following the effective time of the Merger, the Company has satisfied any applicable initial and continuing listing requirements of Nasdaq and the shares of the Company’s Class A Common Stock have been approved for listing on Nasdaq, subject only to official notice of the issuance thereof; and (vi) the S-4 Registration Statement (as defined below) has become effective, no stop order has been issued by the Securities and Exchange Commission (the “**SEC**”) and remains in effect with respect to the S-4 Registration Statement, and no proceeding seeking such a stop order has been threatened or initiated by the SEC and remains pending. In addition, Senti’s obligations to consummate the Merger is subject to the condition that the Closing Available Cash (as defined in the Business Combination Agreement) shall be greater than or equal to \$150,000,000 (after reduction for the aggregate amount of payments made or required to be made in connection with the DYNs Stockholder Redemption (as defined in the Business Combination Agreement)) and the amount of funds available pursuant to the PIPE Financing (as defined in the Business Combination Agreement).

Termination

The Business Combination Agreement may be terminated under certain customary and limited circumstances at any time prior to the Closing, including, without limitation, (i) by the Company or Senti, if (a) the Closing has not occurred by six months from signing (except that such date shall be extended to 9 months from signing in the event the conditions to the Merger have generally been satisfied other than the S-4 Registration Statement becoming effective and such other conditions that by their nature are to be satisfied at the Closing) and (b) a breach of the covenants or obligations of the other party (Senti, on one hand, or the Company or Merger Sub, on the other hand) seeking to terminate the Business Combination Agreement did not proximately cause the failure to consummate the Merger; (ii) by the Company or Senti, in the event an applicable governmental, regulatory or administrative authority has issued a final and non-appealable order having the effect of permanently restraining, enjoining or otherwise prohibiting the Merger; (iii) by the Company or Senti, if Senti or the Company or Merger Sub, as applicable, has breached any of its respective representations, warranties, agreements or covenants contained in the Business Combination Agreement, such failure or breach would render certain conditions precedent to the Closing incapable of being satisfied, and such breach or failure is not cured within 30 days of notice thereof; (iv) by the Company or Senti if the Company's stockholder meeting to vote on the Merger has concluded (including any adjournment or postponement thereof) and the Company Stockholder Approval was not obtained; (v) by the Company, if the Senti Stockholder Approval is not obtained within forty-eight hours following the date that the Registration Statement becomes effective; or (vi) by mutual written consent of the Company and Senti.

If the Business Combination Agreement is validly terminated, none of the parties to the Business Combination Agreement will have any liability or any further obligation under the Business Combination Agreement other than customary confidentiality obligations, except in the case of Willful Breach or Fraud (each, as defined in the Business Combination Agreement).

A copy of the Business Combination Agreement is filed with this Current Report on Form 8-K as Exhibit 2.1 and is incorporated herein by reference, and the foregoing description of the Business Combination Agreement and the Merger does not purport to be complete and is qualified in its entirety by reference thereto. The Business Combination Agreement contains representations, warranties and covenants that the respective parties made to each other as of the date of the Business Combination Agreement or other specific dates. The assertions embodied in those representations, warranties and covenants were made for purposes of the contract among the respective parties and are subject to important qualifications and limitations agreed to by the parties in connection with negotiating the Business Combination Agreement. The Business Combination Agreement is being filed to provide investors with information regarding its terms. It is not intended to provide any other factual information about the parties to the Business Combination Agreement. In particular, the representations, warranties, covenants and agreements contained in the Business Combination Agreement, which were made only for purposes of the Business Combination Agreement and as of specific dates, were solely for the benefit of the parties to the Business Combination Agreement, may be subject to limitations agreed upon by the contracting parties (including being qualified by confidential disclosures made for the purposes of allocating contractual risk between the parties to the Business Combination Agreement instead of establishing these matters as facts) and may be subject to standards of materiality applicable to the contracting parties that differ from those applicable to investors, security holders and reports and documents filed with the SEC. Investors and security holders are not third-party beneficiaries under the Business Combination Agreement and should not rely on the representations, warranties, covenants and agreements, or any descriptions thereof, as characterizations of the actual state of facts or condition of any party to the Business Combination Agreement. In addition, the representations, warranties, covenants and agreements and other terms of the Business Combination Agreement may be subject to subsequent waiver or modification.

Other Agreements

The Business Combination Agreement contemplates the execution of various additional agreements and instruments, on or before the Closing, including, among others, the following:

Sponsor Support Agreement

In connection with the execution of the Business Combination Agreement, Dynamics Sponsor LLC, a Delaware limited liability company (“**Sponsor**”), as the sole holder of the Company’s Class B common stock, par value \$0.0001 per share (the “**Class B Common Stock**”) and other Persons party thereto (“**Other Company Insiders**,” and together with the Sponsor, collectively, the “**Company Insiders**”), entered into a support agreement with the Company and Senti (the “**Sponsor Support Agreement**”). Under the Sponsor Support Agreement, the Sponsor agreed to vote, at any meeting of the stockholders of the Company and in any action by written consent of the stockholders of the Company, all of such Sponsor’s Class A Common Stock and Class B Common Stock (i) in favor of (a) the Business Combination Agreement and the transactions contemplated thereby and (b) the other proposals that the Company and Senti agreed in the Business Combination Agreement shall be submitted at such meeting for approval by the Company’s stockholders together with the proposal to obtain the Company Stockholder Approval, (ii) approval of the Company’s amended and restated charter to change its name, removing those provisions applicable to a special purpose acquisition company and certain other modifications (the “**Required Transaction Proposals**”) and (iii) against any proposal that conflicts with, or materially impedes or interferes with any Required Transaction Proposals or that would adversely affect or delay the Merger. The Sponsor Support Agreement also prohibits the Sponsor from, among other things and subject to certain exceptions, selling, assigning or transferring any Class A Common Stock or Class B Common Stock held by the Sponsor or taking any action that would have the effect of preventing or materially delaying the Sponsor from performing his, her or its obligations under the Sponsor Support Agreement. In addition, in the Sponsor Support Agreement, the Sponsor agreed to waive, and not to assert or perfect, among other things, any rights to adjustment or other anti-dilution protections with respect to the rate at which the shares of Class B Common Stock held by the Sponsor convert into shares of Class A Common Stock in connection with the transactions contemplated by the Business Combination Agreement.

The foregoing description of the Sponsor Support Agreement does not purport to be complete and is qualified in its entirety by the terms and conditions of the Sponsor Support Agreement, a copy of which is attached as Exhibit B to Exhibit 2.1 hereto, and the terms of which are incorporated herein by reference.

Senti Support Agreement

In connection with the execution of the Business Combination Agreement, certain Senti stockholders (the “**Senti Supporting Stockholders**”) entered into support agreements with the Company (the “**Senti Support Agreements**”). Under the Senti Support Agreements, each Senti Supporting Stockholder agreed, within forty-eight hours following the effectiveness of the Registration Statement (as defined in the Business Combination Agreement), to execute and deliver a written consent with respect to all outstanding shares of Senti common stock and preferred stock held by such Senti Supporting Stockholder (the “**Subject Senti Shares**”) approving the Business Combination Agreement and the transactions contemplated thereby. In addition to the foregoing, each Senti Supporting Stockholder agreed that, at any meeting of the holders of Senti capital stock, each such Senti Supporting Stockholder will appear at the meeting, in person or by proxy, and cause its Subject Senti Shares to be voted (i) to approve and adopt the Business Combination Agreement, the transactions contemplated thereby, and any other matters necessary or reasonably requested by Senti for consummation of the Merger; and (ii) against any proposal that conflicts or materially impedes or interferes with, or would adversely affect or delay, the consummation of the transactions contemplated by the Business Combination Agreement.

The Senti Support Agreement also prohibits the Senti Supporting Stockholders from, among other things, (i) transferring any of the Subject Senti Shares; (ii) entering into (a) any option, commitment or other arrangement that would require the Senti Support Stockholders to transfer the Subject Senti Shares, or (b) any voting trust, proxy or other contract with respect to the voting or transfer of the Subject Senti Shares; or (iii) taking any action in furtherance of the foregoing. In addition, under the Senti Support Agreement, each Senti Supporting Stockholder agreed (i) not to exercise any rights of appraisal or dissenter’s rights relating to the Business Combination Agreement and the transactions contemplated thereby and (ii) not to commence or participate in any claim or action against Senti, the Company or any of their affiliates relating to the negotiation, execution or delivery of the Senti Support Agreement or the Business Combination Agreement.

Additionally, certain Senti Support Agreements prohibit the (i) applicable Senti Supporting Stockholders from transferring their shares of Class A Common Stock (or any securities convertible into or exercisable or exchangeable for shares of Class A Common Stock), subject to certain permitted transfers, for up to 18 months following the Closing, which may be reduced to 12 months upon the meeting of certain criteria (such period, the “**Extended Lock-Up**”), and (ii) certain other Senti Support Agreements prohibit the applicable Senti Supporting Stockholders from transferring their shares of Class A Common Stock (or any securities convertible into or exercisable or exchangeable for shares of Class A Common Stock), subject to certain permitted transfers, for 12 months following the Closing (such period, the “**General Lock-Up**”); provided that, (a) with respect to the Extended Lock-Up, if the last reported sale price of the Class A Common Stock on Nasdaq, or any other national securities exchange on which the Class A Common Stock is then traded, is greater than or equal to \$12.00 per share over any 20 trading days within any consecutive 30 trading day period following the Closing Date, then, commencing at least 330 days after the Closing Date, the Lock-Up Period shall be deemed to have expired with respect to each stockholder’s Class A Common Stock subject to the Lock-Up Period and (b) with respect to the General Lock-Up if the last reported sale price of the Class A Common Stock on Nasdaq, or any other national securities exchange on which the Class A Common Stock is then traded, is greater than or equal to \$12.00 per share over any 20 trading days within any consecutive 30 trading day period following the Closing Date, then, commencing at least 150 days after the Closing Date, the Lock-Up Period shall be deemed to have expired with respect to each stockholder’s Class A Common Stock subject to the Lock-Up Period.

The foregoing description of the Senti Support Agreement does not purport to be complete and is qualified in its entirety by the terms and conditions of the Senti Support Agreement, a form of which is attached as Exhibit C and Exhibit D to Exhibit 2.1 hereto, and the terms of which are incorporated herein by reference.

In connection with the execution of the Business Combination Agreement, the Company entered into subscription agreements with certain investors (the “**Subscription Agreements**”), pursuant to which, among other things, certain investors have subscribed to purchase an aggregate of 6,680,000 shares of Class A Common Stock (together, the “**Subscriptions**”) for a purchase price of \$10.00 per share, or an aggregate purchase price of \$66,800,000, which shares are to be issued at the Closing; provided that the Subscription Agreement permits the Company to accept additional Subscriptions for a purchase price of \$10.00 per share to be issued at the Closing, following the execution of the Business Combination Agreement. The obligations of each party to consummate the Subscriptions are conditioned upon, among other things, customary closing conditions and the consummation of the transactions contemplated by the Business Combination Agreement.

The foregoing description of the Subscription Agreements is subject to and qualified in its entirety by reference to the full text of the form of Subscription Agreement, a copy of which is attached as Exhibit 10.1 hereto, and the terms of which are incorporated herein by reference.

Non-Redemption Agreement

In connection with the execution of the Business Combination Agreement, the Sponsor, as the holder of 5,750,000 shares of the Company’s Class B common stock (the “**Sponsor Shares**”), the Company and each of Morgan Stanley Investment Management Inc., T. Rowe Price Group, Inc., The Invs Group, LLC and ARK Investment Management LLC (each, an “**Investor**”, and collectively, the “**Investors**”) entered into a Non-Redemption Agreement (“**Non-Redemption Agreement**”).

Pursuant to the Non-Redemption Agreements, each Investor agreed for the benefit of the Company (a) to not redeem the shares of Class A Common Stock beneficially owned by it, or any other shares, capital stock or other equity interests, as applicable, of the Company, which it holds on the date of the Non-Redemption Agreement representing 8,691,655 shares of Class A Common Stock, in the aggregate (the “**Investor Shares**”), and (b) to not, among other things, sell, encumber or otherwise transfer the Investor Shares other than in connection with non-discretionary ETF or mutual fund pro rata rebalancing transfers. In connection with these commitments from the Investor, the Sponsor has agreed to forfeit 965,728 Sponsor Shares and the Company has agreed to cancel such Sponsor Shares and concurrently issue to the Investors an equivalent number of shares of Class A Common Stock, in each case, at or promptly following the consummation of the Merger. The Sponsor has advised the board of directors of the Company that it believes it is in the best interests of the Company for the Sponsor to forfeit Sponsor Shares pursuant to the Non-Redemption Agreements.

Neither the Sponsor, the Company nor the Investor, either by the terms of the Non-Redemption Agreements or at any time in the future, are to be considered a “group” within the meaning of the Securities Exchange Act of 1934, as amended.

The Sponsor and Company may enter into additional arrangements similar to the Non-Redemption Agreements described above.

The foregoing description of the Non-Redemption Agreements is subject to and qualified in its entirety by reference to the full text of the form of Non-Redemption Agreement, a copy of which is attached as Exhibit 10.2 hereto, and the terms of which are incorporated herein by reference.

Investor Rights Agreement

In connection with the Closing, the Company, certain stockholders of the Company (including the Sponsor) and certain stockholders of Senti will enter into an Investor Rights and Lock-up Agreement (the “**Investor Rights Agreement**”). Pursuant to the Investor Rights Agreement, each signatory thereto (other than the Company) will be granted certain registration rights with respect to their respective shares of Class A Common Stock.

The Investor Rights Agreement will also restrict the ability of each stockholder who is a party thereto (other than the Company) to transfer its shares of Class A Common Stock (or any securities convertible into or exercisable or exchangeable for shares of Class A Common Stock), subject to certain permitted transfers, for a period of one year following the Closing Date (the “**Lock-Up Period**”); provided that (i) the foregoing restrictions shall not apply to any shares of Class A Common Stock purchased pursuant to the Subscription Agreements and (ii) if the last reported sale price of the Class A Common Stock on Nasdaq, or any other national securities exchange on which the Class A Common Stock is then traded, is greater than or equal to \$12.00 per share over any 20 trading days within any consecutive 30 trading day period following the Closing Date, then, commencing at least 150 days after the Closing Date, the Lock-Up Period shall be deemed to have expired with respect to each stockholder’s Class A Common Stock subject to the Lock-Up Period.

The foregoing description of the Investor Rights Agreement does not purport to be complete and is qualified in its entirety by the terms and conditions of the Investor Rights Agreement, a form of which is attached as Exhibit A to Exhibit 2.1 hereto, and the terms of which are incorporated herein by reference.

Item 3.02 Unregistered Sales of Equity Securities.

The disclosure set forth above in Item 1.01 of this Current Report on Form 8-K with respect to the issuance of the Company's Class A Common Stock in connection with the transactions contemplated by the Business Combination Agreement and the Subscription Agreements is incorporated by reference herein. The Class A Common Stock issuable pursuant to the Subscription Agreements will not be registered under the Securities Act, and will be issued in reliance on the exemption from registration provided by Section 4(a)(2) of the Securities Act and/or Regulation D promulgated thereunder.

Item 7.01 Regulation FD Disclosure.

On December 20, 2021, the Company issued a press release announcing that on December 19, 2021, it executed the Business Combination Agreement. A copy of the press release is furnished hereto as Exhibit 99.1.

Furnished as Exhibit 99.2 hereto is the investor presentation that will be used by the Company in connection with the Merger.

The information in this Item 7.01 and Exhibits 99.1 and 99.2 attached hereto shall not be deemed "filed" for purposes of Section 18 of the Securities Exchange Act of 1934, as amended (the "**Exchange Act**"), or otherwise subject to the liabilities of that section, nor shall it be deemed incorporated by reference in any filing under the Securities Act or the Exchange Act, except as expressly set forth by specific reference in such filing.

Important Information About the Merger and Where to Find It

A full description of the terms of the Merger will be provided in the S-4 Registration Statement to be filed with the SEC by the Company, which will include a prospectus with respect to the Company's securities to be issued in connection with the Merger and a proxy statement with respect to the stockholder meeting of the Company to vote on the Merger. The Company urges its investors, stockholders and other interested persons to read, when available, the preliminary proxy statement/prospectus as well as other documents filed with the SEC because these documents will contain important information about the Company, Senti and the Merger. After the S-4 Registration Statement is declared effective, the definitive proxy statement/prospectus to be included in the registration statement will be mailed to stockholders of the Company as of a record date to be established for voting on the proposed Merger. Once available, stockholders will also be able to obtain a copy of the S-4 Registration Statement, including the proxy statement/prospectus, and other documents filed with the SEC without charge, by directing a request to: Dynamics Special Purpose Corp., 2875 El Camino Real, Redwood City, California 94061. The preliminary and definitive proxy statement/prospectus to be included in the S-4 Registration Statement, once available, can also be obtained, without charge, at the SEC's website (www.sec.gov).

Participants in the Solicitation

The Company and Senti and their respective directors and executive officers may be considered participants in the solicitation of proxies with respect to the proposed Merger described in this Current Report on Form 8-K under the rules of the SEC. Information about the directors and executive officers of the Company is set forth in the Company's final prospectus filed with the SEC pursuant to Rule 424(b) of the Securities Act on May 27, 2021, and is available free of charge at the SEC's website at www.sec.gov or by directing a request to: Dynamics Special Purpose Corp., Attn: Secretary, 2875 El Camino Real, Redwood City, California 94061. Information regarding the persons who may, under the rules of the SEC, be deemed participants in the solicitation of the Company's stockholders in connection with the proposed Merger will be set forth in the registration statement containing the proxy statement/prospectus for the proposed Merger when it is filed with the SEC. These documents can be obtained free of charge from the sources indicated above.

Forward-Looking Statements

This Current Report contains forward-looking statements that are based on beliefs and assumptions and on information currently available. In some cases, you can identify forward-looking statements by the following words: "may," "will," "could," "would," "should," "expect," "intend," "plan," "anticipate," "believe," "estimate," "predict," "project," "potential," "continue," "ongoing" or the negative of these terms or other comparable terminology, although not all forward-looking statements contain these words. These statements involve risks, uncertainties and other factors that may cause actual results, levels of activity, performance or achievements to be materially different from the information expressed or implied by these forward-looking statements. Although we believe that we have a reasonable basis for each forward-looking statement contained in this Current Report, we caution you that these statements are based on a combination of facts and factors currently known by us and our projections of the future, about which we cannot be certain. Forward-looking statements in this Current Report include, but are not limited to, statements regarding the proposed Merger, including the timing and structure of the Merger, the proceeds of the Merger, the initial market capitalization of the combined company following the Closing and the benefits of the Merger, as well as statements about the potential attributes and benefits of Senti's product candidates and the format and timing of Senti's product development activities and clinical trials. We cannot assure you that the forward-looking statements in this Current Report will prove to be accurate. These forward-looking statements are subject to a number of significant risks and uncertainties that could cause actual results to differ materially from expected results, including, among others, the ability to complete the Merger due to the failure to obtain approval from the Company's stockholders or satisfy other closing conditions in the Business Combination Agreement, the occurrence of any event that could give rise to the termination of the Business Combination Agreement, the ability to recognize the anticipated benefits of the Merger, the outcome of any legal proceedings that may be instituted against the Company or Senti following announcement of the proposed Merger and related transactions, the impact of COVID-19 on Senti's business and/or the ability of the parties to complete the Merger, the ability to obtain or maintain the listing of the Company's Class A Common Stock on Nasdaq following the proposed Merger, costs related to the proposed Merger, changes in applicable laws or regulations, the possibility that the Company or Senti may be adversely affected by other economic, business, and/or competitive factors and other risks and uncertainties, including those to be included under the header "Risk Factors" in the S-4 Registration Statement to be filed by the Company with the SEC and those included under the header "Risk Factors" in the final prospectus of the Company related to its initial public offering. Most of these factors are outside the Company's and Senti's control and are difficult to predict. Furthermore, if the forward-looking statements prove to be inaccurate, the inaccuracy may be material. In light of the significant uncertainties in these forward-looking statements, you should not regard these statements as a representation or warranty by us or any other person that we will achieve our objectives and plans in any specified time frame, or at all. The forward-looking statements in this Current Report represent our views as of the date of this Current Report. We anticipate that subsequent events and developments will cause our views to change. However, while we may elect to update these forward-looking statements at some point in the future, we have no current intention of doing so except to the extent required by applicable law. You should, therefore, not rely on these forward-looking statements as representing our views as of any date subsequent to the date of this Current Report.

No Offer or Solicitation

This Current Report is not a proxy statement or solicitation of a proxy, consent or authorization with respect to any securities or in respect of the proposed Merger and shall not constitute an offer to sell or a solicitation of an offer to buy any securities, nor shall there be any sale of securities in any state or jurisdiction in which such offer, solicitation, or sale would be unlawful prior to registration or qualification under the securities laws of such state or jurisdiction. No offer of securities shall be made except by means of a prospectus meeting the requirements of the Securities Act.

Item 9.01 Financial Statements and Exhibits.

(d) Exhibits

<u>Exhibit No.</u>	<u>Description</u>
2.1†	Business Combination Agreement, dated as of December 19, 2021, by and among Dynamics Special Purpose Corp., Explore Merger Sub, Inc. and Senti Biosciences, Inc.
10.1	Form of Subscription Agreement
10.2	Form of Non-Redemption Agreement
99.1	Press Release, dated December 20, 2021
99.2	Investor Presentation, dated December 20, 2021
99.3	Dynamics Special Purpose Corp. Business Combination with Senti Biosciences, Inc. Investor Conference Call Script December 19, 2021

† Certain of the exhibits and schedules to this exhibit have been omitted in accordance with Regulation S-K Item 601(b)(2). The Registrant agrees to furnish supplementally a copy of all omitted exhibits and schedules to the SEC upon its request.

SIGNATURE

Pursuant to the requirements of the Securities Exchange Act of 1934, the registrant has duly caused this report to be signed on its behalf by the undersigned hereunto duly authorized.

Dynamics Special Purpose Corp.

By: /s/ Mostafa Ronaghi

Name: Mostafa Ronaghi

Title: Chief Executive Officer

Dated: December 20, 2021

BUSINESS COMBINATION AGREEMENT

BY AND AMONG

DYNAMICS SPECIAL PURPOSE CORP.,

EXPLORE MERGER SUB, INC.

AND

SENTI BIOSCIENCES, INC.

DATED AS OF DECEMBER 19, 2021

TABLE OF CONTENTS

PAGE

ARTICLE 1
CERTAIN DEFINITIONS

Section 1.1	<i>Definitions</i>	4
Section 1.2	<i>Certain Defined Terms</i>	19

ARTICLE 2
THE MERGER

Section 2.1	<i>Closing Transactions</i>	21
Section 2.2	<i>Contingency Consideration</i>	23
Section 2.3	<i>Closing of the Transactions Contemplated by this Agreement</i>	26
Section 2.4	<i>Allocation Schedule</i>	26
Section 2.5	<i>Treatment of Company Options</i>	27
Section 2.6	<i>Closing Actions and Deliverables</i>	27
Section 2.7	<i>Withholding</i>	30

ARTICLE 3
REPRESENTATIONS AND WARRANTIES RELATING TO THE COMPANY

Section 3.1	<i>Organization and Qualification</i>	30
Section 3.2	<i>Capitalization</i>	31
Section 3.3	<i>Authority</i>	32
Section 3.4	<i>Subsidiaries</i>	32
Section 3.5	<i>Financial Statements; Undisclosed Liabilities</i>	33
Section 3.6	<i>Consents and Requisite Governmental Approvals; No Violations</i>	34
Section 3.7	<i>Permits</i>	35
Section 3.8	<i>Material Contracts</i>	35
Section 3.9	<i>Absence of Changes</i>	38
Section 3.10	<i>Litigation</i>	38
Section 3.11	<i>Compliance with Applicable Law</i>	38
Section 3.12	<i>Employee Benefit Plans</i>	39
Section 3.13	<i>Environmental Matters</i>	40
Section 3.14	<i>Intellectual Property</i>	41
Section 3.15	<i>Labor Matters</i>	44
Section 3.16	<i>Insurance</i>	46
Section 3.17	<i>Tax Matters</i>	46
Section 3.18	<i>Brokers</i>	49
Section 3.19	<i>Real and Personal Property</i>	49
Section 3.20	<i>Transactions with Affiliates</i>	49

Section 3.21	<i>Data Privacy and Security</i>	50
Section 3.22	<i>Compliance with International Trade & Anti-Corruption Laws</i>	51
Section 3.23	<i>Information Supplied</i>	51
Section 3.24	<i>Regulatory Compliance</i>	51
Section 3.25	<i>Investigation; No Other Representations</i>	54
Section 3.26	<i>PPP Loans</i>	54
Section 3.27	<i>EXCLUSIVITY OF REPRESENTATIONS AND WARRANTIES</i>	54

ARTICLE 4
REPRESENTATIONS AND WARRANTIES RELATING TO THE DYNs PARTIES

Section 4.1	<i>Organization and Qualification</i>	55
Section 4.2	<i>Authority</i>	56
Section 4.3	<i>Consents and Requisite Governmental Approvals; No Violations</i>	56
Section 4.4	<i>Brokers</i>	57
Section 4.5	<i>Information Supplied</i>	57
Section 4.6	<i>Capitalization</i>	57
Section 4.7	<i>SEC Filings</i>	58
Section 4.8	<i>Trust Account</i>	59
Section 4.9	<i>Transactions with Affiliates</i>	59
Section 4.10	<i>Litigation</i>	60
Section 4.11	<i>Compliance with Applicable Law</i>	60
Section 4.12	<i>Merger Sub Activities</i>	60
Section 4.13	<i>Internal Controls; Listing; Financial Statements</i>	60
Section 4.14	<i>No Undisclosed Liabilities</i>	62
Section 4.15	<i>Employee Matters</i>	62
Section 4.16	<i>Tax Matters</i>	62
Section 4.17	<i>Investigation; No Other Representations</i>	64
Section 4.18	<i>EXCLUSIVITY OF REPRESENTATIONS AND WARRANTIES</i>	65

ARTICLE 5
COVENANTS

Section 5.1	<i>Conduct of Business of the Company</i>	66
Section 5.2	<i>Efforts to Consummate</i>	70
Section 5.3	<i>Confidentiality and Access to Information</i>	71
Section 5.4	<i>Public Announcements</i>	73
Section 5.5	<i>Tax Matters</i>	74
Section 5.6	<i>Exclusive Dealing</i>	75
Section 5.7	<i>Preparation of Registration Statement/Proxy Statement</i>	75
Section 5.8	<i>DYNS Stockholder Approval</i>	77
Section 5.9	<i>Merger Sub Stockholder Approval</i>	78
Section 5.10	<i>Conduct of Business of DYNS</i>	79
Section 5.11	<i>Nasdaq Listing</i>	81

Section 5.12	<i>Trust Account</i>	81
Section 5.13	<i>Company Stockholder Approval</i>	81
Section 5.14	<i>DYNS Indemnification; Directors' and Officers' Insurance</i>	82
Section 5.15	<i>Company Indemnification; Directors' and Officers' Insurance</i>	83
Section 5.16	<i>Post-Closing Directors and Officers</i>	85
Section 5.17	<i>PIPE Subscriptions</i>	86
Section 5.18	<i>Expense Statement</i>	87
Section 5.19	<i>Transaction Litigation</i>	87
Section 5.20	<i>Grant of Options Under New Equity Incentive Plan</i>	88
Section 5.21	<i>Employee Stock Purchase Plan</i>	88
Section 5.22	<i>Section 280G</i>	88
Section 5.23	<i>Company Support Agreements</i>	89

ARTICLE 6

CONDITIONS TO CONSUMMATION OF THE TRANSACTIONS CONTEMPLATED BY THIS AGREEMENT

Section 6.1	<i>Conditions to the Obligations of the Parties</i>	89
Section 6.2	<i>Other Conditions to the Obligations of the DYNS Parties</i>	90
Section 6.3	<i>Other Conditions to the Obligations of the Company</i>	91
Section 6.4	<i>Frustration of Closing Conditions</i>	92

ARTICLE 7 TERMINATION

Section 7.1	<i>Termination</i>	92
Section 7.2	<i>Effect of Termination</i>	94

ARTICLE 8 MISCELLANEOUS

Section 8.1	<i>Non-Survival</i>	94
Section 8.2	<i>Entire Agreement; Assignment</i>	94
Section 8.3	<i>Amendment</i>	94
Section 8.4	<i>Notices</i>	94
Section 8.5	<i>Governing Law</i>	96
Section 8.6	<i>Fees and Expenses</i>	96
Section 8.7	<i>Construction; Interpretation</i>	96
Section 8.8	<i>Exhibits and Schedules</i>	97
Section 8.9	<i>Parties in Interest</i>	97
Section 8.10	<i>Severability</i>	97
Section 8.11	<i>Counterparts; Electronic Signatures; Effectiveness</i>	98
Section 8.12	<i>Knowledge of Company; Knowledge of DYNS</i>	98
Section 8.13	<i>No Recourse</i>	98
Section 8.14	<i>Extension; Waiver</i>	98
Section 8.15	<i>Waiver of Jury Trial</i>	99

Section 8.16	Submission to Jurisdiction	99
Section 8.17	<i>Remedies</i>	100
Section 8.18	<i>Trust Account Waiver</i>	100

ANNEXES AND EXHIBITS

Exhibit A	Form of Investor Rights Agreement
Exhibit B	Sponsor Support Agreement
Exhibit C	Form of Company Support Agreement
Exhibit D	Form of Major Holder Support Agreement

BUSINESS COMBINATION AGREEMENT

This BUSINESS COMBINATION AGREEMENT (this “**Agreement**”), dated as of December 19, 2021, is made by and among Dynamics Special Purpose Corp., a Delaware corporation (“**DYNS**”), Explore Merger Sub, Inc., a Delaware corporation (“**Merger Sub**”), and Senti Biosciences, Inc., a Delaware corporation (the “**Company**”). DYNS, Merger Sub and the Company shall be referred to herein from time to time collectively as the “**Parties**” (and each a “**Party**”). Capitalized terms used herein have the meanings set forth in Section 1.1 and Section 1.2.

WHEREAS, (a) DYNS is a blank check company incorporated as a Delaware corporation on March 1, 2021 for the purpose of effecting a merger, capital stock exchange, asset acquisition, stock purchase, reorganization or similar business combination with one or more businesses, and (b) Merger Sub is, as of the date of this Agreement, a wholly-owned Subsidiary of DYNS that was formed for purposes of consummating the transactions contemplated by this Agreement and the Ancillary Documents;

WHEREAS, pursuant to the Governing Documents of DYNS, DYNS is required to provide an opportunity for its stockholders to have their outstanding shares of Class A Common Stock redeemed on the terms and subject to the conditions set forth therein in connection with obtaining the DYNS Stockholder Approval;

WHEREAS, as of the date of this Agreement, DYNS’s initial stockholders, including Dynamics Sponsor LLC, a Delaware limited liability company (the “**Sponsor**”), collectively own 5,750,000 shares of Class B Common Stock;

WHEREAS, on the Closing Date, upon the terms and conditions set forth herein and in accordance with the General Corporation Law of the State of Delaware (the “**DGCL**”), Merger Sub will merge with and into the Company (the “**Merger**”), with the Company as the surviving company in the Merger and, after giving effect to such merger, a wholly-owned Subsidiary of DYNS, and each Company Share will be converted into the right to receive the Merger Consideration, on the terms and subject to the conditions set forth in this Agreement;

WHEREAS, concurrently with the execution of this Agreement, DYNS will enter into subscription agreements (collectively, the “**Subscription Agreements**”) with certain investors (collectively, the “**Investors**”) pursuant to which, among other things, the Investors will agree to subscribe for and purchase, and DYNS will agree to issue and sell to the Investors, a number of shares of Class A Common Stock as set forth in each applicable Subscription Agreement in exchange for an aggregate purchase price of \$66,800,000, on the terms and subject to the conditions set forth therein (such equity financing hereinafter referred to as the “**PIPE Financing**”);

WHEREAS, concurrently with the execution of this Agreement, DYNS, the Sponsor and certain Pre-Closing DYNS Stockholders will enter into non-redemption agreements (the “**Non-Redemption Agreements**”), pursuant to which, among other things (a) each Pre-Closing DYNS Stockholder which is a signatory thereto will agree, for the benefit of DYNS, (i) to not exercise its Redemption Rights in respect of (x) the Class A Common Stock beneficially owned by it, or (y) any other shares, capital stock or other equity interests, as applicable, of DYNS, which it holds on the date of the Non-Redemption Agreement, and (ii) to not, among other things, sell, encumber or otherwise transfer such Class A Common Stock or other shares, capital stock, or equity interests, (b) the Sponsor will agree to forfeit to DYNS certain Class B Common Stock which it holds, and (c) DYNS will agree to cancel such Class B Common Stock of the Sponsor and concurrently issue to the Pre-Closing DYNS Stockholder an equivalent number of shares of Class A Common Stock, in the case of clauses (b) and (c) above, at or promptly following the consummation of the Merger and, in each case, on the terms and subject to the conditions therein;

WHEREAS, at the Closing, DYNS, certain stockholders of DYNS (including the Sponsor) and certain stockholders of the Company shall enter into an investor rights agreement, substantially in the form attached hereto as Exhibit A (the “**Investor Rights Agreement**”), pursuant to which, among other things, each signatory thereto (other than DYNS) will (a) agree not to effect any sale or distribution of any shares of Class A Common Stock held by any of them during the lock-up period described therein, and (b) be granted certain registration rights with respect to their respective shares of Class A Common Stock, in each case, on the terms and subject to the conditions therein;

WHEREAS, concurrently with the execution of this Agreement, DYNS, the Sponsor and the Company, among others, will enter into the stockholder support agreement attached hereto as Exhibit B (the “**Sponsor Support Agreement**”), pursuant to which, among other things, the Sponsor will agree (a) to vote its shares of Class B Common Stock in favor of the Required Transaction Proposals, (b) not to transfer its shares of Class B Common Stock, and (c) to waive any adjustment to the conversion ratio set forth in the Governing Documents of DYNS or any other anti-dilution or similar protection with respect to its shares of Class B Common Stock in connection with the transactions contemplated by this Agreement, in each case, on the terms and subject to the conditions set forth in the Sponsor Support Agreement;

WHEREAS, concurrently with the execution of this Agreement, certain Company Stockholders will enter into stockholder support agreements in the form attached hereto as Exhibit C (the “**Company Support Agreements**”), pursuant to which, among other things, such Company Stockholders will agree (a) to, as promptly as practicable following the time at which the Registration Statement/Proxy Statement shall have been declared effective and made available to such Company Stockholders, vote their Company Shares in favor of, or execute written consents to adopt and approve, upon the effectiveness of the Registration Statement/Proxy Statement, this Agreement, any Ancillary Documents to which the Company is or will be a party, the Merger and the other transactions contemplated by this Agreement and any Ancillary Documents to which the Company is or will be a party, (b) not to transfer, prior to the Closing, such Company Stockholder’s Company Shares, subject to the exceptions set forth therein, and (c) not to transfer, following the Closing, such Company Stockholder’s shares of Class A Common Stock constituting such Company Stockholder’s Merger Consideration for a period of twelve months following the Closing, subject to the exceptions set forth therein;

WHEREAS, concurrently with the execution of this Agreement, certain Company Stockholders will enter into stockholder support agreements in the form attached hereto as Exhibit D (the “**Major Holder Support Agreements**”), pursuant to which, among other things, such Company Stockholders will agree (a) to, as promptly as practicable following the time at which the Registration Statement/Proxy Statement shall have been declared effective and made available to such Company Stockholders, vote their Company Shares in favor of, or execute written consents to adopt and approve, upon the effectiveness of the Registration Statement/Proxy Statement, this Agreement, any Ancillary Documents to which the Company is or will be a party, the Merger and the other transactions contemplated by this Agreement and any Ancillary Documents to which the Company is or will be a party, (b) not to transfer, prior to the Closing, such Company Stockholder’s Company Shares, subject to the exceptions set forth therein, and (c) not to transfer, following the Closing, such Company Stockholder’s shares of Class A Common Stock constituting such Company Stockholder’s Merger Consideration for a period of eighteen months following the Closing, subject to the exceptions set forth therein;

WHEREAS, the board of directors of the Company (the “**Company Board**”) has unanimously (a) determined that this Agreement, the Ancillary Documents to which the Company is or will be party and the transactions contemplated hereby and thereby (including the Merger) are in the best interests of, and are advisable to, the Company and the Company Stockholders, (b) approved and declared advisable this Agreement, the Ancillary Documents to which the Company is or will be party and the transactions contemplated hereby and thereby (including the Merger), and (c) resolved to recommend that the Company Stockholders adopt and approve this Agreement, the Ancillary Documents to which the Company is or will be party and the transactions contemplated hereby and thereby (including the Merger);

WHEREAS, the board of directors of DYNs (the “**DYNS Board**”) has unanimously (a) determined that this Agreement, the Ancillary Documents to which a DYNs Party is or will be party and the transactions contemplated hereby and thereby (including the Merger) are in the best interests of, and advisable to, DYNs and its stockholders, (b) approved and declared advisable this Agreement, the Ancillary Documents to which a DYNs Party is or will be party and the transactions contemplated hereby and thereby (including the Merger), and (c) resolved to recommend that its stockholders adopt this Agreement and the Ancillary Documents to which a DYNs Party is or will be party;

WHEREAS, the board of directors of Merger Sub has unanimously (a) determined that this Agreement, the Ancillary Documents to which Merger Sub is or will be party and the transactions contemplated hereby and thereby (including the Merger) are in the best interests of, and advisable to, Merger Sub and its sole stockholder, (b) approved and declared advisable this Agreement, the Ancillary Documents to which Merger Sub is or will be party and the transactions contemplated hereby and thereby (including the Merger), and (c) recommended that its sole stockholder adopt and approve this Agreement, the Ancillary Documents to which Merger Sub is or will be party and the transactions contemplated hereby and thereby (including the Merger); and

WHEREAS, each of the Parties intends that, for U.S. federal income tax purposes, (a) this Agreement constitutes a “plan of reorganization” within the meaning of Section 368 of the Code and Treasury Regulations promulgated thereunder, and (b) the Merger constitutes a “reorganization” within the meaning of Section 368(a) of the Code (clause (b) being the “**Intended Tax Treatment**”).

NOW, THEREFORE, in consideration of the premises and the mutual promises set forth herein and for other good and valuable consideration, the receipt and sufficiency of which are hereby acknowledged, the Parties, each intending to be legally bound, hereby agree as follows:

ARTICLE 1
CERTAIN DEFINITIONS

Section 1.1 *Definitions*. As used in this Agreement, the following terms have the respective meanings set forth below.

“**Affiliate**” means, with respect to any Person, any other Person who directly or indirectly, through one or more intermediaries, controls, is controlled by, or is under common control with, such Person. The term “control” means the possession, directly or indirectly, of the power to direct or cause the direction of the management and policies of a Person, whether through the ownership of voting securities, by contract or otherwise, and the terms “controlled” and “controlling” have meanings correlative thereto.

“**Affordable Care Act**” means the Patient Protection and Affordable Care Act of 2010.

“**Aggregate Consideration**” means, collectively, the Merger Consideration and, if any, the Contingency Consideration.

“**Ancillary Documents**” means the Investor Rights Agreement, the Subscription Agreements, the Sponsor Support Agreement, the Non-Redemption Agreements, the Company Support Agreements, the Major Holder Support Agreements, and each other agreement, document, instrument or certificate contemplated by this Agreement executed or to be executed in connection with the transactions contemplated hereby.

“**Anti-Corruption Laws**” means, collectively, (a) the U.S. Foreign Corrupt Practices Act, (b) the UK Bribery Act 2010, and (c) any other anti-bribery or anti-corruption Laws related to combating bribery, corruption and money laundering, each as applicable.

“**Available Closing Cash**” means, as of the Closing (a) the amount of funds contained in the Trust Account (after reduction for the aggregate amount of payments made or required to be made in connection with the DYNS Stockholder Redemption), *plus* (b) the amount of funds available to consummate the Merger pursuant to the PIPE Financing, in each case, before giving effect to the payment of any Transaction Expenses.

“**Business**” means engineering CAR-NK cells and other engineered cells with the Company’s gene logic platform, in each case, as conducted by the Company and its Subsidiaries as of the date of this Agreement.

“**Business Day**” means a day, other than a Saturday or Sunday, on which commercial banks in New York, New York are open for the general transaction of business.

“**Change of Control Payment**” means (a) any success, change of control, retention, severance, transaction bonus or other similar payment to any Person that is payable due solely to the consummation of the transactions contemplated by this Agreement or any Ancillary Document, or (b) any payments made or required to be made pursuant to or in connection with or upon termination of, and any fees, expenses or other payments owing in respect of, any Company Related Party Transaction (in the case of each of clause (a) and (b), regardless of whether paid or payable prior to, at or after the Closing or in connection with or otherwise related to this Agreement or any Ancillary Document).

“**Class A Common Stock**” means Class A common stock, \$0.0001 par value, of DYNS.

“**Class B Common Stock**” means Class B common stock, \$0.0001 par value, of DYNS.

“**Code**” means the U.S. Internal Revenue Code of 1986, as amended.

“**Company Acquisition Proposal**” means, except as set forth on Section 1.1 of the Company Disclosure Schedules, (a) any transaction or series of related transactions under which any Person(s), directly or indirectly, acquires or otherwise purchases (i) the Company, or (ii) all or substantially all of the assets or businesses of the Company and its Subsidiaries (in the case of each of clause (i) and (ii), whether by merger, consolidation, recapitalization, purchase or issuance of equity securities, tender offer or otherwise), or (b) any material equity or similar investment in the Company or any of its Subsidiaries. Notwithstanding the foregoing or anything to the contrary herein, none of this Agreement, the Ancillary Documents or the transactions contemplated hereby or thereby shall constitute a Company Acquisition Proposal.

“**Company Business Intellectual Property**” means collectively, the Company Owned Intellectual Property and the Company Licensed Intellectual Property.

“**Company Certificate of Incorporation**” means the Amended and Restated Certificate of Incorporation of the Company, effective as of October 20, 2020.

“**Company Common Stock**” means common stock, par value \$0.0001 per share, of the Company.

“**Company Disclosure Schedules**” means the disclosure schedules to this Agreement delivered to DYNs by the Company on the date of this Agreement.

“**Company Equity Plan**” means the Company’s 2016 Stock Incentive Plan, as adopted on July 25, 2016 and as amended from time to time, including most recently on February 9, 2018.

“**Company Expenses**” means, as of any determination time, the aggregate amount of fees, expenses, commissions or other amounts incurred by or on behalf of the Company or any of its Subsidiaries, whether or not due and payable, and not otherwise expressly allocated to a DYNs Party pursuant to the terms of this Agreement or any Ancillary Document, in connection with the negotiation, preparation or execution of this Agreement or any Ancillary Documents, the performance of its covenants or agreements in this Agreement or any Ancillary Document or the consummation of the transactions contemplated hereby or thereby, including (a) the fees and expenses of outside legal counsel, accountants, advisors, brokers, investment bankers, consultants, or other agents or service providers of the Company, and (b) any other fees, expenses, commissions or amounts that are expressly allocated to the Company or any of its Subsidiaries pursuant to this Agreement or any Ancillary Document. Notwithstanding the foregoing or anything to the contrary herein, Company Expenses shall not include any DYNs Expenses.

“**Company Fundamental Representations**” means the representations and warranties set forth in Section 3.1(a) (*Organization and Qualification*), Section 3.2(a), Section 3.2(b) and Section 3.2(d) (*Capitalization*), Section 3.3 (*Authority*), Section 3.9 (*Absence of Changes*) and Section 3.18 (*Brokers*).

“**Company IT Systems**” means any and all computer systems, Software and hardware, communication systems, servers, network equipment and related documentation, in each case, owned, used, licensed, or leased by the Company or its Subsidiaries.

“**Company Licensed Intellectual Property**” means any and all Intellectual Property Rights owned by or licensed to any Person (other than the Company or any of its Subsidiaries) that are licensed or sublicensed (or purported to be licensed or sublicensed) to the Company or any of its Subsidiaries, for which the Company or any of its Subsidiaries has obtained (or purported to have obtained) a covenant not to be sued.

“**Company Material Adverse Effect**” means any Effect that, individually or in the aggregate with any other Effect, has had or would reasonably be expected to have a material adverse effect on (a) the business, assets, results of operations or condition (financial, regulatory, clinical or otherwise) of the Company and its Subsidiaries, taken as a whole, or (b) the ability of the Company to consummate the Merger; *provided, however*, that in the case of clause (a), none of the following shall be taken into account in determining whether a Company Material Adverse Effect has occurred or would be

reasonably expected to occur; any adverse Effect arising from or related to (i) general business or economic conditions in or affecting the United States, or changes therein, or the global economy generally, (ii) any national or international political or social conditions in the United States or any other country, including the engagement by the United States or any other country in hostilities, whether or not pursuant to the declaration of a national emergency or war, or the occurrence in any place of any military or terrorist attack, sabotage or cyberterrorism, (iii) changes in conditions of the financial, banking, capital or securities markets generally in the United States or any other country or region in the world, or changes therein, including changes in interest rates in the United States or any other country and changes in exchange rates for the currencies of any countries, (iv) changes or proposed changes in any applicable Laws or GAAP after the date of this Agreement, (v) any Effect that is generally applicable to the industries or markets in which the Company and its Subsidiaries operate, (vi) the execution or public announcement of this Agreement or the pendency or consummation of the transactions contemplated by this Agreement, including the impact thereof on the relationships, contractual or otherwise, of the Company and its Subsidiaries with employees, Contingent Workers, customers, investors, contractors, lenders, suppliers, vendors, partners, licensors, licensees or other third parties related thereto (*provided* that the exception in this clause (vi) shall not apply to the representations and warranties set forth in Section 3.6(b) to the extent that their purpose is to address the consequences resulting from the public announcement or pendency or consummation of the transactions contemplated by this Agreement, or the condition set forth in Section 6.2(a) to the extent it relates to such representations and warranties), (vii) any failure by the Company and its Subsidiaries, taken as a whole, to meet, or changes to, any internal or published budgets, projections, forecasts, estimates or predictions (although the underlying facts and circumstances resulting in such failure may be taken into account to the extent not otherwise excluded from this definition pursuant to clauses (i) through (vi) or (viii)), or (viii) any hurricane, tornado, flood, earthquake, tsunami, natural disaster, mudslides, wild fires, epidemics or pandemics or the worsening of any pandemics (including COVID-19), acts of God or other natural disasters or comparable events in the United States or any other country or region in the world, or any escalation of the foregoing; *provided, however*, that any Effect resulting from a matter described in any of the foregoing clauses (i) through (v) or (viii) may be taken into account in determining whether a Company Material Adverse Effect has occurred or would be reasonably expected to occur to the extent, and solely to the extent, such Effect has a disproportionate adverse effect on the Company and its Subsidiaries, taken as a whole, relative to other participants operating in the industries or markets in which the Company and its Subsidiaries operate.

“Company Option” means, as of any determination time, each option to purchase shares of Company Common Stock granted to any current or former director, manager, officer, employee, Contingent Worker or other service provider of the Company or any of its Subsidiaries that is outstanding and unexercised .

“Company Owned Intellectual Property” means any and all Intellectual Property Rights that are owned or purported to be owned by the Company or any of its Subsidiaries.

“**Company Preferred Stock**” means, collectively, the Company Series A Preferred Stock and the Company Series B Preferred Stock.

“**Company Product**” means each product candidate that is being researched, tested, developed or manufactured by or on behalf of the Company or any of its Subsidiaries.

“**Company Registered Intellectual Property**” means any and all Registered Intellectual Property owned or purported to be owned by the Company or any of its Subsidiaries, including all Registered Intellectual Property filed by or filed in the name of the Company or any of its Subsidiaries as of January 1, 2018.

“**Company Series A Preferred Stock**” means preferred stock, par value \$0.0001 per share, of the Company designated as “Series A Preferred Stock” pursuant to the Company Certificate of Incorporation.

“**Company Series B Preferred Stock**” means preferred stock, par value \$0.0001 per share, of the Company designated as “Series B Preferred Stock” pursuant to the Company Certificate of Incorporation.

“**Company Shares**” means, collectively, the Company Preferred Stock and the Company Common Stock.

“**Company Stockholders**” means, collectively, the holders of Company Common Stock and the Company Preferred Stock as of any determination time prior to the Effective Time.

“**Confidentiality Agreement**” means that certain Confidential Disclosure Agreement, dated as of June 18, 2021, between the Company and DYNs.

“**Consent**” means any notice, authorization, qualification, registration, filing, notification, waiver, order, consent or approval to be obtained from, filed with or delivered to, a Governmental Entity or other Person.

“**Contingent Worker**” means any individual independent contractor, consultant, contractor, temporary employee or leased employee currently being used by the Company and its Subsidiaries and classified by them as other than an employee, or compensated other than through Form W-2 wages paid by them, through their payroll functions.

“**Contract**” or “**Contracts**” means any written agreement, contract, license, lease, obligation, undertaking or other commitment or arrangement that is legally binding upon a Person or any of his, her or its properties or assets.

“**Copyrights**” has the meaning set forth in the definition of Intellectual Property Rights.

“COVID-19” means SARS-CoV-2 or COVID-19, and any evolutions thereof or related or associated epidemics, pandemics or disease outbreaks.

“**DYNS Acquisition Proposal**” means any transaction or series of related transactions under which DYNS or any of its Affiliates, directly or indirectly (i) acquires or otherwise purchases any other Person(s), (ii) engages in a business combination with any other Person(s), or (iii) acquires or otherwise purchases at least a majority of the voting securities of such Person(s) or all or substantially all of the assets or businesses of any other Persons(s) (in the case of each of clauses (i), (ii) and (iii), whether by merger, consolidation, recapitalization, purchase or issuance of equity securities, tender offer or otherwise). Notwithstanding the foregoing or anything to the contrary herein, none of this Agreement, the Ancillary Documents or the transactions contemplated hereby or thereby shall constitute a DYNS Acquisition Proposal.

“**DYNS Certificate of Incorporation**” means the Amended and Restated Certificate of Incorporation of Dynamics Special Purpose Corp., effective as of May 24, 2021.

“**DYNS Common Stock**” means Class A Common Stock and Class B Common Stock.

“**DYNS Disclosure Schedules**” means the disclosure schedules to this Agreement delivered to the Company by DYNS on the date of this Agreement.

“**DYNS Expenses**” means, as of any determination time, the aggregate amount of fees, expenses, commissions or other amounts incurred by or on behalf of any DYNS Party, whether or not due and payable, and not otherwise expressly allocated to the Company pursuant to the terms of this Agreement or any Ancillary Document, in connection with the negotiation, preparation or execution of this Agreement or any Ancillary Documents, the performance of its covenants or agreements in this Agreement or any Ancillary Document or the consummation of the transactions contemplated hereby or thereby, including (a) the fees and expenses of outside legal counsel, accountants, advisors, brokers, investment bankers, consultants or other agents or service providers of any DYNS Party, and (b) any other fees, expenses, commissions or amounts that are expressly allocated to any DYNS Party pursuant to this Agreement or any Ancillary Document. Notwithstanding the foregoing or anything to the contrary herein, DYNS Expenses shall not include (a) any Company Expenses, or (b) the cost of the DYNS D&O Tail Policy.

“**DYNS Fundamental Representations**” means the representations and warranties set forth in Section 4.1 (*Organization and Qualification*), Section 4.2 (*Authority*), Section 4.4 (*Brokers*) and Section 4.6(a) and Section 4.6(b) (*Capitalization*).

“DYNS Material Adverse Effect” means any Effect that, individually or in the aggregate with any other Effect, has had or would reasonably be expected to have a material adverse effect on (a) the business, assets, results of operations or condition (financial, regulatory or otherwise) of the DYNS Parties, taken as a whole, or (b) the ability of DYNS or Merger Sub to consummate the Merger; *provided, however*, that, in the case of clause (a), none of the following shall be taken into account in determining whether a DYNS Material Adverse Effect has occurred or would be reasonably expected to occur: any adverse Effect arising from or related to (i) general business or economic conditions in or affecting the United States, or changes therein, or the global economy generally, (ii) any national or international political or social conditions in the United States or any other country, including the engagement by the United States or any other country in hostilities, whether or not pursuant to the declaration of a national emergency or war, or the occurrence in any place of any military or terrorist attack, sabotage or cyberterrorism, (iii) changes in conditions of the financial, banking, capital or securities markets generally in the United States or any other country or region in the world, or changes therein, including changes in interest rates in the United States or any other country and changes in exchange rates for the currencies of any countries, (iv) changes or proposed changes in any applicable Laws or GAAP after the date of this Agreement, (v) any Effect that is generally applicable to the industries or markets in which any DYNS Party operates, (vi) the execution or public announcement of this Agreement or the pendency or consummation of the transactions contemplated by this Agreement, including the impact thereof on the relationships, contractual or otherwise, of any DYNS Party with investors, contractors, lenders, suppliers, vendors, partners, licensors, licensees or other third parties related thereto (*provided* that the exception in this clause (vi) shall not apply to the representations and warranties set forth in Section 4.3(b) to the extent that their purpose is to address the consequences resulting from the public announcement or pendency or consummation of the transactions contemplated by this Agreement or the condition set forth in Section 6.3(a) to the extent it relates to such representations and warranties), (vii) any failure by any DYNS Party to meet, or changes to, any internal or published budgets, projections, forecasts, estimates or predictions (although the underlying facts and circumstances resulting in such failure may be taken into account to the extent not otherwise excluded from this definition pursuant to clauses (i) through (vi) or (viii)), (viii) any hurricane, tornado, flood, earthquake, tsunami, natural disaster, mudslides, wild fires, epidemics or pandemics or the worsening of any pandemics (including COVID-19), acts of God or other natural disasters or comparable events in the United States or any other country or region in the world, or any escalation of the foregoing, (ix) any Effect relating to the Company or its Subsidiaries or the Company Stockholders, (x) any DYNS Stockholder Redemption, in and of itself, or (xi) any breach of any covenants, agreements or obligations of an Investor under a Subscription Agreement (including any breach of an Investor’s obligations to fund its commitment thereunder when required); *provided, however*, that any Effect resulting from a matter described in any of the foregoing clauses (i) through (v) or (viii) may be taken into account in determining whether a DYNS Material Adverse Effect has occurred or would be reasonably expected to occur to the extent, and solely to the extent, such Effect has a disproportionate adverse effect on the DYNS Parties, taken as a whole, relative to other “SPACs” operating in the industries in which the DYNS Parties operate.

“DYNS Parties” means, collectively, DYNS and Merger Sub.

“DYNS Share Value” means \$10.00.

“DYNS Stockholder Approval” means the approval of each Required Transaction Proposal by the affirmative vote of the holders of the requisite number of DYNS Common Stock entitled to vote thereon, whether in person or by proxy at the DYNS Stockholders Meeting (or any adjournment or postponement thereof), in accordance with the Governing Documents of DYNS and applicable Law.

“DYNS Stockholder Redemption” means the right of the holders of Class A Common Stock to redeem all or a portion of their Class A Common Stock (in connection with the transactions contemplated by this Agreement or otherwise) as set forth in the DYNS Certificate of Incorporation.

“Effect” means any state of facts, event, change, effect, occurrence, circumstance or development.

“Employee Benefit Plan” means each (A) “employee benefit plan” (as such term is defined in Section 3(3) of ERISA, whether or not subject to ERISA), (B) each stock option plan, stock purchase plan, bonus or incentive plan, severance pay plan, program or arrangement, deferred compensation arrangement or agreement, employment agreement, compensation plan, program, agreement or arrangement, change in control plan, program or arrangement, supplemental income arrangement, vacation plan and each other employee benefit plan, program, policy, agreement and arrangement not described in (A) above, and (C) each plan or arrangement providing compensation to employee and non-employee directors, in each case that the Company or any of its Subsidiaries maintain, sponsor or contribute to or has any obligation to contribute to, or under or with respect to which the Company or any of its Subsidiaries has or may have any present or future Liability (including as an ERISA Affiliate).

“Environmental Laws” means all Laws and Orders concerning pollution, protection of the environment, or human health or safety.

“Equity Securities” means any share, share capital, capital stock, partnership, membership, unit, joint venture or similar interest in any Person (including any stock appreciation, phantom stock, profit participation or similar rights), and any option, warrant, right or security (including debt securities) convertible, exchangeable or exercisable therefor.

“Equity Value” means \$240,000,000.

“Equity Value Per Share” means (a) the Equity Value, *divided by* (b) the Fully Diluted Company Capitalization.

“ERISA” means the Employee Retirement Income Security Act of 1974.

“ERISA Affiliate” means any entity, trade or business that is, or at any applicable time was, a member of a group described in Section 414(b), (c), (m) or (o) of the Code or Section 4001(b)(1) of ERISA that includes the Company or any of its Subsidiaries.

“Exchange Act” means the Securities Exchange Act of 1934.

“Exchange Ratio” means (a) the Equity Value Per Share, *divided by* (b) the DYNs Share Value.

“FDA” means the U.S. Food and Drug Administration, or any successor agency thereto.

“Federal Securities Laws” means U.S. federal securities laws and the rules and regulations of the SEC promulgated thereunder or otherwise.

“Fraud” with respect to any Party, means a Willful Breach by such Party of the representations and warranties set forth in Article 3 or Article 4, as applicable, or in any certificate delivered hereunder, with the intent that another Party rely on such representations and warranties, coupled with such other Party’s detrimental reliance on such representations and warranties under circumstances that constitute common law fraud under the Laws of the State of New York. For the avoidance of doubt, “Fraud” does not include any claim for equitable fraud, promissory fraud, unfair dealings fraud or any torts based on negligence or recklessness.

“Fully Diluted Company Capitalization” means, without duplication, the sum of (a) the aggregate number of shares of Company Common Stock outstanding as of immediately prior to the Effective Time, determined on an as-converted basis (including, for the avoidance of doubt, the number of shares of Company Common Stock issuable upon conversion of a share of Company Preferred Stock based on the then applicable conversion ratio), and (b) the aggregate number of shares of Company Common Stock (on a net exercise basis) subject to Company Options to the extent not included in clause (a) as of immediately prior to the Effective Time (excluding for this purpose the number of shares of Company Common Stock subject to the Closing Option Awards).

“GAAP” means United States generally accepted accounting principles.

“Good Laboratory Practices” mean the then current standards for conducting nonclinical laboratory studies, as set forth in the FDCA and applicable regulations promulgated thereunder, as amended from time to time, including applicable requirements contained in 21 C.F.R. Part 58, and such applicable standards of good laboratory practices as are required by Governmental Entities in any other countries in which the Company Products are intended to be sold.

“Governing Documents” means the legal document(s) by which any Person (other than an individual) establishes its legal existence or other organizational documents of such Person. For example, the “Governing Documents” of a U.S. corporation are its certificate or articles of incorporation and by-laws, the “Governing Documents” of a U.S. limited partnership are its limited partnership agreement and certificate of limited partnership and the “Governing Documents” of a U.S. limited liability company are its operating or limited liability company agreement and certificate of formation.

“Governmental Entity” means any United States or non-United States (a) federal, state, local, municipal or other government, (b) governmental or quasi- governmental entity of any nature (including any governmental agency, branch, department, official or entity and any court or other tribunal), or (c) body exercising or entitled to exercise any administrative, executive, judicial, legislative, police, regulatory or taxing authority or power of any nature, including any arbitral tribunal (public or private).

“Healthcare Laws” means all Laws relating to patient care or human health and safety, including, as amended from time to time, any such Law pertaining to the research (including preclinical, nonclinical and clinical research or studies), development, testing, production, manufacture, transfer, storing, distribution, approval, labeling, marketing, pricing, third-party reimbursement or sale of biological products, including (i) the FDCA and the Public Health Service Act (42 U.S.C. §201 et seq.), and (ii) all Laws relating to any federal health care program (as such term is defined in 42 U.S.C. § 1320a-7b(f)), including the federal Anti-Kickback Statute (42 U.S.C. § 1320a-7b(b)), the Stark Anti-Self-Referral Law (42 U.S.C. § 1395nn), the civil False Claims Act (31 U.S.C. § 3729 et seq.), the administrative False Claims Law (42 U.S.C. § 1320a-7b(a)), Sections 1320a-7, 1320a-7a, and 1320a-7b of Title 42 of the United States Code and any comparable self-referral or fraud and abuse laws promulgated by any Governmental Entity, the 21st Century Cures Act (Pub. L. 114-255), and any state or federal Law the purpose of which is to protect the privacy of individually-identifiable patient information, Medicare (Title XVIII of the Social Security Act) and Medicaid (Title XIX of the Social Security Act), the Affordable Care Act, as amended by the Health Care and Education Affordability Reconciliation Act of 2010, TRICARE (10 U.S.C. Section 1071 et seq.), the Sunshine/Open Payments Law (42 U.S.C. § 1320a-7h) and similar state or foreign Laws related to the reporting of manufacturer payments or transfers of value to health care professionals, in each case including the associated rules and regulations promulgated thereunder and all of their foreign equivalents, and any other requirements of Law relating to the Business.

“HSR Act” means the Hart-Scott-Rodino Antitrust Improvements Act of 1976 and the rules and regulations promulgated thereunder.

“Incentive Stock Option” means a Company Option intended to be an “incentive stock option” (as defined in Section 422 of the Code).

“Indebtedness” means, as of any time, without duplication, with respect to any Person, the outstanding principal amount of, accrued and unpaid interest on, fees and expenses arising under or in respect of (a) indebtedness for borrowed money, (b) other obligations evidenced by any note, bond, debenture or other debt security, (c) obligations for the deferred purchase price of property or assets, including “earn-outs” and “seller notes” (but excluding any trade payables arising in the ordinary course of business), (d) reimbursement and other obligations with respect to letters of credit, bank guarantees, bankers’ acceptances or other similar instruments, in each case, solely to the extent drawn, (e) leases required to be capitalized under GAAP, (f) derivative, hedging, swap, foreign exchange or similar arrangements, including swaps, caps, collars, hedges or similar arrangements, and (g) any of the obligations of any other Person of the type referred to in clauses (a) through (f) above directly or indirectly guaranteed by such Person or secured by any assets of such Person, whether or not such Indebtedness has been assumed by such Person.

“Intellectual Property Rights” means any and all intellectual property rights and related priority rights protected, created or arising under the Laws of the United States or any other jurisdiction or under any international convention, including all (a) patents and patent applications, industrial designs and design patent rights, including any continuations, divisionals, continuations-in-part and provisional applications and statutory invention registrations, and any patents issuing on any of the foregoing and any reissues, reexaminations, substitutes, supplementary protection certificates or extensions of any of the foregoing (collectively, **“Patents”**), (b) trademarks, service marks, trade names, service names, brand names, trade dress rights, logos, Internet domain names, social media accounts or identifiers, corporate names and other source or business identifiers, together with the goodwill associated with any of the foregoing, and all applications, registrations, extensions and renewals of any of the foregoing (collectively, **“Marks”**), (c) copyrights and rights in works of authorship, design rights, mask work rights and moral rights, whether or not registered or published, and all registrations, applications, renewals, extensions and reversions of any of any of the foregoing (collectively, **“Copyrights”**), (d) trade secrets, know-how and confidential and proprietary information, including invention disclosures, inventions and formulae, whether patentable or not, (e) rights in or to Software or other technology, (f) rights in databases and compilations, including rights in data and collections of data, whether machine readable or otherwise and (g) any other intellectual or proprietary rights protectable, arising under or associated with any of the foregoing, including those protected by any Law anywhere in the world.

“Investment Company Act” means the Investment Company Act of 1940.

“Key Employee” means any individual employed by the Company or any of its Subsidiaries with a title of “vice president” or who directly reports to, or is, the Chief Executive Officer.

“Law” means any federal, state, local, foreign, national or supranational statute, law (including common law), act, ordinance, treaty, rule, code, regulation or other binding directive issued, promulgated or enforced by a Governmental Entity having jurisdiction over a given matter.

“Liability” or **“liability”** means any and all debts and liabilities, whether accrued or fixed, absolute or contingent, known or unknown, matured or unmatured or determined or determinable, including those arising under any Law (including any Environmental Law), Proceeding or Order and those arising under any Contract.

“Lien” means any mortgage, pledge, security interest, encumbrance, lien, license or sub-license, charge, covenant not to sue granted to a third party, or other similar encumbrance or interest (including, in the case of any Equity Securities, any voting, transfer or similar restrictions).

“**Marks**” has the meaning set forth in the definition of Intellectual Property Rights.

“**Merger Consideration**” means (a) with respect to each outstanding share of Company Common Stock, a number of shares of Class A Common Stock equal to the Exchange Ratio, and (b) with respect to each outstanding share of Company Preferred Stock, a number of shares of Class A Common Stock equal to (i) the aggregate number of shares of Company Common Stock that would be issued upon conversion of such Company Preferred Stock into Company Common Stock based on the applicable conversion ratio immediately prior to the Effective Time, as set forth in the Allocation Schedule, multiplied by (ii) the Exchange Ratio.

“**Nasdaq**” means the Nasdaq Stock Market LLC.

“**Off-the-Shelf Software**” means any Software that is made generally and widely available to the public on a commercial basis and is licensed to the Company or any of its Subsidiaries on a non-exclusive basis under standard terms and conditions.

“**Order**” means any outstanding writ, order, judgment, injunction, decision, determination, award, ruling, subpoena, verdict or decree entered, issued or rendered by any Governmental Entity.

“**Pandemic Measures**” means (i) any “shelter-in-place,” “stay at home,” workforce reduction, furlough, employee time off, employee leave, social distancing, shut down, closure, sequester, business or workplace reopening, or other conditions, restrictions or requirements pursuant to any Law, order, directive, pronouncement, guideline or recommendation of or by any Governmental Entity, the Centers for Disease Control and Prevention, the Occupational Safety and Health Administration, the Equal Employment Opportunity Commission or the World Health Organization in connection with or in respect of COVID-19 or any other pandemic, epidemic, public health emergency or virus or disease outbreak, and (ii) any acts or omissions by the Company or its Subsidiaries that have been or may be taken in a commercially reasonable manner as a reasonable good faith response to COVID-19, or to the extent necessary to avoid, mitigate or remediate a material adverse effect on the Company, its Subsidiaries or the Business as may result from COVID-19.

“**Patents**” has the meaning set forth in the definition of Intellectual Property Rights.

“**PCAOB**” means the Public Company Accounting Oversight Board.

“**Permits**” means any approvals, Consents, authorizations, clearances, licenses, registrations, permits or certificates of or issued by a Governmental Entity.

“Permitted Liens” means (a) mechanic’s, materialmen’s, carriers’, repairers’ and other similar statutory Liens arising or incurred in the ordinary course of business for amounts that are not yet delinquent or are being contested in good faith by appropriate proceedings and for which sufficient reserves have been established in accordance with GAAP, (b) Liens for Taxes, assessments or other governmental charges not yet delinquent as of the Closing Date or which are being contested in good faith by appropriate proceedings and for which sufficient reserves have been established in accordance with GAAP, (c) encumbrances and restrictions on real property (including easements, covenants, conditions, rights of way and similar restrictions) that do not prohibit or materially interfere with the Company’s or its Subsidiaries’ use or occupancy of such real property for the operation of the Business, (d) zoning, building codes and other land use Laws regulating the use or occupancy of real property or the activities conducted thereon which are imposed by any Governmental Entity having jurisdiction over such real property and which are not violated by the use or occupancy of such real property for the operation of the Business and do not prohibit or materially interfere with the Company’s or its Subsidiaries’ use or occupancy of such real property for the operation of the Business, (e) in the case of the Leased Real Property, any Lien granted by any lessor, developer or third-party on any fee interest underlying the Leased Real Property, (f) the Real Property Leases, (g) cash deposits or cash pledges to secure the payment of workers’ compensation, unemployment insurance, social security benefits or obligations arising under similar Laws or to secure the performance of public or statutory obligations, surety or appeal bonds, and other obligations of a like nature, in each case in the ordinary course of business and which are not yet due and payable, and (h) non-exclusive grants by the Company or its Subsidiaries of Intellectual Property Rights in the ordinary course of business consistent with past practice and that are not material to the Company or any of its Subsidiaries.

“Person” means an individual, partnership, corporation, limited liability company, joint stock company, unincorporated organization or association, trust, joint venture or other similar entity, whether or not a legal entity.

“Personal Data” means any data in the Company’s possession, custody, or control, that identifies, or that could reasonably be used to identify, any natural person or device or household.

“Pre-Closing DYNS Stockholders” means the holders of DYNS Common Stock at any time prior to the Effective Time.

“Privacy Laws” means all applicable Laws that govern the Processing of Personal Data or governing privacy, data protection, data security, or data or security breach notification.

“Proceeding” means any lawsuit, litigation, action, audit, complaint, proceeding, suit, arbitration or mediation (in each case, whether civil, criminal or administrative and whether public or private) pending by or before any Governmental Entity.

“Process” (or **“Processing”** or **“Processes”**) means the collection, use, storage, processing, recording, distribution, transfer, import, export, protection (including security measures), disposal or disclosure or other activity regarding Personal Data (whether electronically or in any other form or medium).

“Real Property Leases” means all leases, sub-leases, licenses or other agreements, in each case, as amended from time to time and pursuant to which the Company or, if applicable, any of its Subsidiaries, leases or sub-leases any real property.

“Redemption Rights” means the redemption rights provided for in Sections 9.2 and 9.7 of the DYNS Certificate of Incorporation.

“Registered Intellectual Property” means all issued Patents, pending Patent applications, registered Marks, pending applications for registration of Marks, registered Copyrights, pending applications for registration of Copyrights and Internet domain name registrations.

“Regulatory Permits” means all Permits granted by the FDA or any comparable Governmental Entity to the Company or any of its Subsidiaries, including investigational new drug applications, Biologics License Applications, manufacturing approvals and authorizations, clinical trial authorizations and ethical reviews, or their national or foreign equivalents.

“Representatives” means, with respect to a Person, such Person’s directors, officers and employees, and legal, financial, internal and independent accounting and other advisors and representatives.

“Required Governing Document Proposals” means the approval of the Amended and Restated Certificate of Incorporation and Bylaws of DYNS in the form mutually agreed upon by DYNS and the Company.

“Sanctions and Export Control Laws” means any applicable Law in any part of the world related to (a) import and export controls, including the U.S. Export Administration Regulations, (b) economic sanctions, including those administered by the Office of Foreign Assets Control of the U.S. Department of the Treasury, the U.S. Department of State, the European Union, any European Union Member State, the United Nations and Her Majesty’s Treasury of the United Kingdom or (c) anti-boycott measures.

“Sarbanes-Oxley Act” means the Sarbanes-Oxley Act of 2002.

“Schedules” means, collectively, the Company Disclosure Schedules and the DYNS Disclosure Schedules.

“SEC” means the U.S. Securities and Exchange Commission.

“Securities Act” means the U.S. Securities Act of 1933.

“Securities Laws” means Federal Securities Laws and other applicable foreign and domestic securities or similar Laws.

“**Software**” means any and all (a) computer programs, including any and all software implementations of algorithms, models and methodologies, whether in source code or object code, (b) descriptions, flowcharts and other work product used to design, plan, organize and develop any of the foregoing and, to the extent embodied in any of the foregoing, screens, user interfaces, report formats, firmware, development tools, templates, menus, buttons and icons, and (c) documentation, including user manuals and other training documentation, related to any of the foregoing.

“**Subsidiary**” means, with respect to any Person, any corporation, limited liability company, partnership or other legal entity of which (a) if a corporation, a majority of the total voting power of shares of stock entitled (without regard to the occurrence of any contingency) to vote in the election of directors, managers or trustees thereof is at the time owned or controlled, directly or indirectly, by such Person or one or more of the other Subsidiaries of such Person or a combination thereof, or (b) if a limited liability company, partnership, association or other business entity (other than a corporation), a majority of the partnership or other similar ownership interests thereof is at the time owned or controlled, directly or indirectly, by such Person or one or more Subsidiaries of such Person or a combination thereof and for this purpose, a Person or Persons own a majority ownership interest in such a business entity (other than a corporation) if such Person or Persons shall be allocated a majority of such business entity’s gains or losses or shall be a, or control any, managing director or general partner of such business entity (other than a corporation). The term “Subsidiary” shall include all Subsidiaries of such Subsidiary.

“**Tax**” means any federal, state, local or non-U.S. income, gross receipts, franchise, estimated, alternative minimum, sales, use, transfer, value added, excise, stamp, customs, duties, ad valorem, real property, personal property (tangible and intangible), capital stock, social security, unemployment, payroll, wage, employment, severance, occupation, registration, communication, mortgage, profits, license, lease, service, goods and services, withholding, premium, unclaimed property, escheat, turnover, windfall profits or other taxes or other like governmental fees or assessments, in each case, in the nature of taxes, together with any interest, deficiencies, penalties, additions to tax or additional amounts imposed by any Governmental Entity with respect thereto.

“**Tax Authority**” means any Governmental Entity responsible for the collection or administration of Taxes or Tax Returns.

“**Tax Return**” means returns, information returns, statements, declarations or claims for refund, together with any schedules thereto or amendments thereof, relating to Taxes filed or required to be filed with any Governmental Entity.

“**Transaction Expenses**” means all fees, expenses, commissions or other amounts incurred by or on behalf of the Company and its Subsidiaries or any DYNs Party, prior to and through the Closing Date, and whether paid or unpaid prior to or at the Closing, in connection with DYNs’s initial public offering, the negotiation, preparation and execution of this Agreement and the Ancillary Documents, the performance of and compliance with the terms of this Agreement and the Ancillary Documents to be performed or complied with at or before Closing and the consummation of the all transactions contemplated hereby and thereby, including (i) any deferred underwriter

fees, discounts and commissions in connection with DYNS's initial public offering, (ii) the unreimbursed fees, costs, expenses and disbursements of legal counsel, accountants, advisors and consultants of the Company and its Subsidiaries or any DYNS Party, (iii) the fees, costs and expenses incurred in connection with the PIPE Financing, including any cash financing fees or third-party advisory expenses in connection therewith, (iv) the costs and expenses associated with any filings with or notifications to any Governmental Entity in connection with the transactions contemplated by this Agreements or the Ancillary Documents, including pursuant to the HSR Act, and (v) the fees, costs and expenses associated with the preparation and filing of the Registration Statement/Proxy Statement and the DYNS Stockholders Meeting.

“**Transaction Share Consideration**” means an aggregate number of shares of Class A Common Stock equal to (a) the Equity Value, *divided by* (b) the DYNS Share Value.

“**Unpaid DYNS Expenses**” means the DYNS Expenses that are unpaid as of the relevant determination date.

“**Unpaid Company Expenses**” means the Company Expenses that are unpaid as of the relevant determination date.

“**Unvested Company Option**” means each Company Option outstanding as of immediately prior to the Effective Time that is not a Vested Company Option.

“**Vested Company Option**” means each Company Option outstanding as of immediately prior to the Effective Time that is vested as of such time or will vest in connection with the consummation of the transactions contemplated hereby (whether at the Effective Time or otherwise).

“**WARN Act**” means the Worker Adjustment Retraining and Notification Act of 1988, as well as analogous applicable foreign, state or local Laws.

“**Willful Breach**” means an intentional and willful breach, or an intentional and willful failure to perform, in each case, that is the consequence of an act or omission by a Party with the knowledge that the taking of such act or failure to take such act would cause a breach of this Agreement.

Section 1.2 *Certain Defined Terms*. Each of the following terms is defined in the Section set forth opposite such term:

<u>Term</u>	<u>Section</u>
Additional Company Financial Statements	5.7
Additional DYNS SEC Reports	4.7
Agreement	Introduction
Allocation Schedule	2.4
Audited Company Financial Statements	3.5

<u>Term</u>	<u>Section</u>
CARES Act	3.17(o)
Certificate of Merger	2.1(a)(ii)
Certificates	2.1(a)(vii)
Closing	2.3
Closing Date	2.3
Closing Filing	5.4(b)
Closing Option Awards	5.20
Closing Press Release	5.4(b)
Company	Introduction
Company Board	Recitals
Company D&O Persons	5.15(a)
Company D&O Tail Policy	5.15(c)
Company Designees	5.16(b)
Company Financial Statements	3.5
Company Related Party	3.20
Company Related Party Transactions	3.20
Company Stockholder Written Consent	5.13
Company Stockholder Written Consent Deadline	5.13
Contingency Consideration	2.2(a)(ii)
Creator	3.14(e)
DGCL	Recitals
DYNS	Introduction
DYNS Board	Recitals
DYNS D&O Persons	5.14(a)
DYNS D&O Tail Policy	5.14(c)
DYNS Designee	5.16(c)
DYNS Financial Statements	4.13(d)
DYNS Related Party	4.9
DYNS Related Party Transactions	4.9
DYNS SEC Reports	4.7
DYNS Stockholders Meeting	5.8
Effective Time	2.1(a)(ii)
Enforceability Exceptions	3.3
Exchange Agent	2.6(a)
Exchange Agent Agreement	2.6(a)
Exchange Fund	2.6(c)

<u>Term</u>	<u>Section</u>
FDCA	3.24(c)
First Level Contingency Consideration	2.2(a)(i)
First Outside Date	2.2(a)(i)
First Share Target	2.2(a)(i)
Government Funded IP	3.14(l)
Intended Tax Treatment	Recitals
Interim Period	5.1
Investor Rights Agreement	Recitals
Investors	Recitals
Leased Real Property	3.19(b)
Letter of Transmittal	2.6(b)
Licensed Patents	3.14(a)
Material Contracts	3.8(a)
Material Permits	3.7
Merger	Recitals
Merger Sub	Introduction
New Equity Incentive Plan	5.7
New ESPP	5.21
Non-Redemption Agreements	Recitals
Officers	5.16(b)
Outside Dates	2.2(a)(ii)
Parties	Introduction
Permitted Transfer	2.2(e)
PIPE Financing	Recitals
Privacy and Data Security Policies	3.21(a)
Privacy Requirements	3.21(a)
Proxy Statement/Prospectus	5.7
Public Stockholders	8.18
Registration Statement	5.7
Registration Statement/Proxy Statement	5.7
Required Transaction Proposals	5.8
Rollover Option	2.5(a)
Second Level Contingency Consideration	2.2(a)(ii)
Second Outside Date	2.2(a)(ii)
Second Share Target	2.2(a)(ii)
Share Targets	2.2(a)(ii)
Signing Filing	5.4(b)
Signing Press Release	5.4(b)
Sponsor	Recitals
Sponsor Support Agreement	Recitals
Subscription Agreements	Recitals
Subsidiary Securities	3.4(b)
Surviving Corporation	2.1(a)(i)

<u>Term</u>	<u>Section</u>
Termination Date	7.1(d)
Transaction Litigation	5.19
Trust Account	8.18
Trust Agreement	4.8
Trustee	4.8
Unaudited Company Financial Statements	3.5
VWAP	2.2(a)(i)

ARTICLE 2
THE MERGER

Section 2.1 *Closing Transactions*. On the terms and subject to the conditions set forth in this Agreement, the following transactions shall occur in the order set forth in this Section 2.1:

(a) Merger.

(i) On the terms and subject to the conditions set forth in this Agreement and in accordance with the DGCL, on the Closing Date, Merger Sub shall merge with and into the Company at the Effective Time. Following the Effective Time, the separate existence of Merger Sub shall cease and the Company shall continue as the surviving company of the Merger (the “**Surviving Corporation**”).

(ii) At the Closing, the Parties shall cause a certificate of merger, in a form reasonably satisfactory to the Company and DYNs (the “**Certificate of Merger**”), to be executed and filed with the Secretary of State of the State of Delaware. The Merger shall become effective on the date and time at which the Certificate of Merger is accepted for filing by the Secretary of State of the State of Delaware or at such later date or time as is agreed by DYNs and the Company and specified in the Certificate of Merger (the time the Merger becomes effective being referred to herein as the “**Effective Time**”).

(iii) The Merger shall have the effects set forth in Section 251 of the DGCL. Without limiting the generality of the foregoing, and subject thereto, at the Effective Time, all of the assets, properties, rights, privileges, powers and franchises of the Company and Merger Sub shall vest in the Surviving Corporation and all Liabilities, obligations, restrictions, disabilities and duties of or applicable to each of the Company and Merger Sub shall become the Liabilities, obligations, restrictions, disabilities and duties of or applicable to the Surviving Corporation, in each case, in accordance with the DGCL.

(iv) At the Effective Time, the Governing Documents of Merger Sub shall be the Governing Documents of the Surviving Corporation, in each case, until thereafter changed or amended as provided therein or by applicable Law.

(v) At the Effective Time, the directors and officers of the Company immediately prior to the Effective Time shall be the initial directors and officers of the Surviving Corporation, each to hold office in accordance with the Governing Documents of the Surviving Corporation until such director's or officer's successor is duly elected or appointed and qualified, or until the earlier of their death, resignation or removal.

(vi) At the Effective Time, by virtue of the Merger and without any action on the part of any Party or any other Person, each share of capital stock of Merger Sub issued and outstanding immediately prior to the Effective Time shall be converted into one share of common stock, par value \$0.0001, of the Surviving Corporation.

(vii) At the Effective Time, by virtue of the Merger and without any action on the part of any Party or any other Person, each Company Share (other than the Company Shares cancelled in accordance with clause (viii) immediately below) issued and outstanding as of immediately prior to the Effective Time shall be canceled and extinguished and be converted into the right to receive a number of shares of Class A Common Stock equal to the Merger Consideration. From and after the Effective Time, the holder(s) of certificates (the "**Certificates**"), if any, evidencing ownership of Company Shares and the Company Shares held in book-entry form issued and outstanding immediately prior to the Effective Time shall each cease to have any rights with respect to such Company Shares except as otherwise expressly provided for herein or under applicable Law.

(viii) At the Effective Time, by virtue of the Merger and without any action on the part of any Party or any other Person, each Company Share held immediately prior to the Effective Time by the Company as treasury stock shall be canceled and extinguished, and no consideration shall be paid with respect thereto.

Section 2.2 Contingency Consideration.

(a) Following the Closing, in addition to the consideration to be received pursuant to Sections 2.1(a)(vii) and 2.5 and as part of the overall Aggregate Consideration, Company Stockholders shall be issued additional shares of Class A Common Stock, as follows:

(i) one million (1,000,000) shares of Class A Common Stock, in the aggregate, if, on or before the date which is two (2) calendar years after the Closing Date (the "**First Outside Date**"), the volume weighted average price of shares of Class A Common Stock on Nasdaq, or any other national securities exchange on which the shares of Class A Common Stock are then traded ("**VWAP**"), is greater than or equal to fifteen dollars (\$15.00) over any twenty (20) trading days within any consecutive thirty (30) trading day period (the "**First Share Target**") (such 1,000,000 shares of Class A Common Stock, the "**First Level Contingency Consideration**"); and

(ii) one million (1,000,000) shares of Class A Common Stock, in the aggregate, if, on or before the date which is three (3) calendar years after the Closing Date (the “**Second Outside Date**” and, together with the First Outside Date, the “**Outside Dates**”), the VWAP is greater than or equal to twenty dollars (\$20.00) over any twenty (20) trading days within any consecutive thirty (30) trading day period (the “**Second Share Target**” and, together with the First Share Target, the “**Share Targets**”) (such 1,000,000 shares of Class A Common Stock, the “**Second Level Contingency Consideration**” and, together with the First Level Contingency Consideration, the “**Contingency Consideration**”). For the avoidance of doubt, each of the First Level Contingency Consideration and the Second Level Contingency Consideration is issuable only once in accordance with the terms of this Section 2.2(a), and the maximum amount of Contingency Consideration is two million (2,000,000) shares of Class A Common Stock, in the aggregate.

(b) If either of the Share Targets shall have been achieved, then within ten (10) Business Days following the achievement of the applicable Share Target (which may be achieved at the same time or over the same or overlapping trading days), DYNs shall issue the applicable Contingency Consideration to each Company Stockholder as specified on the Allocation Schedule.

(c) Following the Closing, if a Change of Control of DYNs shall occur on or before the applicable Outside Date set forth in Section 2.2(a)(i) or Section 2.2(a)(ii), respectively, then if (i) the per share value of the consideration to be received by holders of Class A Common Stock in connection with the Change of Control exceeds \$15.00 per share and the First Share Target has not been previously achieved, then the First Share Target shall be deemed to have been achieved, and (ii) the per share value of the consideration to be received by holders of Class A Common Stock in connection with the Change of Control exceeds \$20.00 per share and the Second Share Target has not been previously achieved, then the Second Share Target shall be deemed to have been achieved. If either or both Share Targets are deemed to have been achieved, then any Contingency Consideration that remains unissued as of immediately prior to the consummation of such Change of Control shall immediately become payable and the Company Stockholders shall be entitled to receive such Contingency Consideration prior to the consummation of such Change of Control; *provided*, that any Contingency Consideration that is not deemed to be earned in connection with the Change of Control in accordance with this Section 2.2(c) shall be forfeited by the Company Stockholder(s) for no consideration. Any Contingency Consideration shall be payable to the Company Stockholders as specified on the Allocation Schedule. For the purposes of this Agreement, a “**Change of Control**” shall have been deemed to occur with respect to DYNs upon:

(i) the sale, lease, license, distribution, dividend or transfer, in a single transaction or a series of related transactions, of more than fifty percent (50%) of the assets of DYNs and its Subsidiaries taken as a whole; or

(ii) a merger, consolidation or other business combination of DYNS (or any Subsidiary or Subsidiaries that alone or together represent more than fifty percent (50%) of the consolidated business of DYNS at that time) or any successor or other entity holding, directly or indirectly, fifty percent (50%) or more of all the assets of DYNS and its Subsidiaries that results in the stockholders of DYNS (or such Subsidiary or Subsidiaries) or any successor or other entity holding, directly or indirectly, fifty percent (50%) or more of the assets of DYNS and its Subsidiaries or the surviving entity thereof, as applicable, immediately before the consummation of such transaction or series of related transactions holding, directly or indirectly, less than fifty percent (50%) of the voting power of DYNS (or such Subsidiary or Subsidiaries) or any successor, other entity or surviving entity thereof, as applicable, immediately following the consummation of such transaction or series of related transactions.

(d) The Contingency Consideration and the Share Targets shall be adjusted to reflect appropriately the effect of any stock split, reverse stock split, stock dividend (including any dividend or distribution of securities convertible into shares of Class A Common Stock), reorganization, recapitalization, reclassification, combination, exchange of shares or other like change with respect to Class A Common Stock, occurring on or after the date hereof and prior to the time any such Contingency Consideration is delivered to the Company Stockholders, if any.

(e) The right of the Company Stockholders to receive the Contingency Consideration (i) is solely a contractual right and will not be evidenced by a certificate and does not constitute a security or other instrument, (ii) may not be sold, assigned, transferred, pledged, encumbered or in any other manner transferred or disposed of, in whole or in part, other than upon written notice to DYNS pursuant to a Permitted Transfer, and (iii) does not give the Company Stockholders any right to receive interest payments. There is no guaranty or other assurance of any kind that any Contingency Consideration will be payable hereunder (regardless of any projections, models, forecasts or any other financial data generated by, or provided to, the Company, DYNS or their respective Affiliates or Representatives). For purposes of this Agreement, "**Permitted Transfer**" means (A) a transfer on death by will or intestacy, (B) a transfer by instrument to an inter vivos or testamentary trust for beneficiaries upon the death of the trustee, (C) a transfer made pursuant to an order of a court of competent jurisdiction (such as in connection with divorce, bankruptcy or liquidation), (D) a transfer by a partnership or limited liability company through a distribution to its partners or members, as applicable, in each case without consideration, or (E) a transfer made by operation of law (including a consolidation or merger) or as pursuant to the dissolution, liquidation or termination of any corporation, limited liability company, partnership or other entity.

(f) If the consideration to be received by holders of Class A Common Stock in a Change of Control includes non-cash consideration, then the value of such consideration for the purposes of Section 2.2(c) shall be determined in good faith by the DYNS Board.

Section 2.3 *Closing of the Transactions Contemplated by this Agreement*. The closing of the transactions contemplated by this Agreement (the “**Closing**”) shall take place at the offices of Goodwin Procter LLP, 620 Eighth Avenue, New York, NY 10018 as promptly as reasonably practicable, but in no event later than the third (3rd) Business Day, following the satisfaction (or, to the extent permitted by applicable Law, waiver) of the conditions set forth in Article 6 (other than those conditions that by their nature are to be satisfied at the Closing, but subject to satisfaction or waiver of such conditions) (the “**Closing Date**”) or at such other place, date or time as DYNs and the Company may agree in writing, or electronically by exchange of the closing deliverables by the means provided in Section 8.11.

Section 2.4 *Allocation Schedule*. No later than five (5) Business Days prior to the Closing Date, the Company shall deliver to DYNs an allocation schedule (the “**Allocation Schedule**”) setting forth (a) the number of Equity Securities held by each Company Stockholder, the number of shares of Company Common Stock subject to each Company Option held by each holder thereof, as well as whether each such Company Option will be a Vested Company Option or an Unvested Company Option as of immediately prior to the Effective Time, and, in the case of the Company Options, the exercise price thereof, as well as reasonably detailed calculations with respect to the components and subcomponents thereof, (b) the number of shares of Class A Common Stock that will be subject to each Rollover Option and the exercise price of each such Rollover Option at the Effective Time, in each case, determined in accordance with Section 2.5, as well as reasonably detailed calculations with respect to the components and subcomponents thereof, (c) the portion of the Transaction Share Consideration allocated to each Company Stockholder pursuant to Section 2.1(a)(vii), as well as reasonably detailed calculations with respect to the components and subcomponents thereof, (d) the portion of the Contingency Consideration allocated to each Company Stockholder, in the event that any Contingency Consideration becomes payable, as well as reasonably detailed calculations with respect to the components and subcomponents thereof, and (e) a certification, duly executed by an authorized officer of the Company, that the information and calculations delivered pursuant to clauses (a), (b), (c) and (d) are, and will be as of immediately prior to the Effective Time, (i) true and correct in all respects, and (ii) in accordance with the applicable provisions of this Agreement, the Governing Documents of the Company and applicable Laws and, in the case of Company Options, the Company Equity Plan and any applicable grant or similar agreement with respect to any such Company Option. The Company will review any comments to the Allocation Schedule provided by DYNs or any of its Representatives and consider in good faith and incorporate any reasonable comments proposed by DYNs or any of its Representatives to correct inaccuracies. Notwithstanding the foregoing or anything to the contrary herein, the aggregate number of shares of Class A Common Stock that each Company Stockholder will have a right to receive pursuant to Section 2.1(a)(vii) will be rounded down to the nearest whole share.

Section 2.5 Treatment of Company Options.

(a) At the Effective Time, by virtue of the Merger and without any action of any Party or any other Person (but subject to, in the case of the Company, Section 2.5(c)), each Company Option (whether a Vested Company Option or an Unvested Company Option) shall cease to represent the right to purchase shares of Company Common Stock and shall be converted into an option to purchase shares of Class A Common Stock (each, a “**Rollover Option**”) in an amount, at an exercise price and subject to such terms and conditions determined as set forth below. Each Rollover Option shall (i) be exercisable for, and represent the right to purchase, a number of shares of Class A Common Stock (rounded down to the nearest whole share) equal to (A) the number of shares of Company Common Stock subject to the corresponding Company Option immediately prior to the Effective Time, *multiplied by* (B) the Exchange Ratio, and (ii) have an exercise price per share of Class A Common Stock (rounded up to the nearest whole cent) subject to such Rollover Option equal to (A) the exercise price per share of Company Common Stock applicable to the corresponding Company Option immediately prior to the Effective Time, *divided by* (B) the Exchange Ratio. Each Rollover Option shall be subject to the same terms and conditions (including applicable vesting, expiration and forfeiture provisions) that applied to the corresponding Company Option immediately prior to the Effective Time, except for terms rendered inoperative by reason of the transactions contemplated by this Agreement or the Ancillary Documents or for such other immaterial administrative or ministerial changes as the DYNS Board (or the compensation committee of the DYNS Board) may determine in good faith are appropriate to effectuate the administration of the Rollover Options. Such conversion shall occur in a manner intended to comply with (x) for any Rollover Option that is an Incentive Stock Option, the requirements of Section 424 of the Code, and (y) in each case, the requirements of Section 409A of the Code.

(b) At the Effective Time, DYNS shall assume the Company Equity Plan and (i) all Company Options (whether vested or unvested) shall no longer be outstanding and shall automatically be converted into Rollover Options, and each holder thereof shall cease to have any rights with respect thereto or under the Company Equity Plan, except as otherwise expressly provided for in this Section 2.5, and (ii) all shares of Company Common Stock reserved for issuance pursuant to the Company Equity Plan shall automatically be cancelled.

(c) Prior to the Closing, the Company shall take, or cause to be taken, all necessary or appropriate actions under the Company Equity Plan (and the underlying grant, award or similar agreements) or otherwise to give effect to the provisions of this Section 2.5.

Section 2.6 Closing Actions and Deliverables.

(a) At least five (5) Business Days prior to the Closing Date, DYNS shall appoint an exchange agent reasonably acceptable to the Company (the “**Exchange Agent**”) (it being understood and agreed, for the avoidance of doubt, that Continental Stock Transfer & Trust Company shall be deemed to be acceptable to the Company) and enter into an exchange agent agreement with the Exchange Agent (the “**Exchange Agent Agreement**”) for the purpose of exchanging Certificates, if any, representing the Company Shares, and each Company Share held in book-entry form on the stock transfer books of the Company immediately prior to the Effective Time, for the portion of the Merger Consideration issuable in respect of such Company Share pursuant to Section 2.1(a)(vii), and on the terms and subject to the other conditions set forth in this Agreement.

(b) At least three (3) Business Days prior to the Closing Date, the Company shall mail or otherwise deliver, or shall cause to be mailed or otherwise delivered, to the Company Stockholders a letter of transmittal in a customary form to be mutually agreed between the Parties (a “**Letter of Transmittal**”); *provided* that any representations and warranties made by a Company Stockholder in a Letter of Transmittal shall be limited to authority, title to the applicable Company Shares and absence of Liens on the applicable Company Shares.

(c) Prior to the Effective Time, DYNs shall deposit, or cause to be deposited, with the Exchange Agent, for the benefit of the Company Stockholders and for exchange in accordance with this Section 2.6 through the Exchange Agent, evidence of Class A Common Stock in book-entry form representing the portion of the Merger Consideration issuable pursuant to Section 2.1(a)(vii) in exchange for the Company Shares outstanding immediately prior to the Effective Time. All shares in book-entry form representing the portion of the Merger Consideration issuable pursuant to Section 2.1(a)(vii) deposited with the Exchange Agent shall be referred to in this Agreement as the “**Exchange Fund**”.

(d) Each Company Stockholder whose Company Shares have been converted into the right to receive a portion of the Merger Consideration pursuant to Section 2.1(a)(vii) shall be entitled to receive the portion of the Merger Consideration to which he, she or it is entitled on the date provided in Section 2.6(e) upon (i) surrender of a Certificate (or affidavit of loss, in lieu thereof, in the form required by the Letter of Transmittal), together with the delivery of a properly completed and duly executed Letter of Transmittal (including, for the avoidance of doubt, any documents or agreements required by the Letter of Transmittal), to the Exchange Agent, or (ii) delivery of an “agent’s message” in the case of Company Common Stock held in book-entry form, together with the delivery of a properly completed and duly executed Letter of Transmittal (including, for the avoidance of doubt, any documents or agreements required by the Letter of Transmittal), to the Exchange Agent.

(e) If a properly completed and duly executed Letter of Transmittal, together with any Certificates (or affidavit of loss, in lieu thereof, in the form required by the Letter of Transmittal) or an “agent’s message”, as applicable, is delivered to the Exchange Agent in accordance with Section 2.6(d) (i) at least one (1) Business Day prior to the Closing Date, then DYNs and the Company shall take all necessary actions to cause the applicable portion of the Merger Consideration to be issued to the applicable Company Stockholder in book-entry form on the Closing Date, or (ii) less than one (1) Business Day prior to or on or after the Closing Date, then DYNs and the Company (or the Surviving Corporation) shall take all necessary actions to cause the applicable portion of the Merger Consideration to be issued to the Company Stockholder in book-entry form within two (2) Business Days after such delivery.

(f) If any portion of the Merger Consideration is to be issued to a Person other than the Company Stockholder in whose name the surrendered Certificate is, or the transferred Company Shares in book-entry form are, registered, it shall be a condition to the issuance of the applicable portion of the Merger Consideration that (i) either such Certificate shall be properly endorsed or shall otherwise be in proper form for transfer, or such Company Shares in book-entry form shall be properly transferred, and (ii) the Person requesting such consideration pay to the Exchange Agent any transfer or similar Taxes required as a result of such consideration being issued to a Person other than the registered holder of such Certificate or Company Shares in book-entry form, or establish to the satisfaction of the Exchange Agent that such transfer or similar Taxes have been paid or are not payable.

(g) No interest will be paid or accrued on the Merger Consideration (or any portion thereof). From and after the Effective Time, until surrendered or transferred, as applicable, in accordance with this Section 2.6, each Company Share (other than, for the avoidance of doubt, the Company Shares cancelled in accordance with Section 2.1(a)(viii)) shall solely represent the right to receive a portion of the Merger Consideration to which such Company Share is entitled pursuant to Section 2.1(a)(vii).

(h) At the Effective Time, the stock transfer books of the Company shall be closed and there shall be no transfers of Company Shares that were outstanding immediately prior to the Effective Time.

(i) Any portion of the Exchange Fund that remains unclaimed by the Company Stockholders twelve (12) months following the Closing Date shall be delivered to DYNS or as otherwise instructed by DYNS, and any Company Stockholder who has not exchanged his, her or its Company Shares for the applicable portion of the Merger Consideration in accordance with this Section 2.6 prior to that time shall thereafter look only to DYNS for the issuance of the applicable portion of the Merger Consideration, without any interest thereon. None of DYNS, the Surviving Corporation or any of their respective Affiliates shall be liable to any Person in respect of any consideration delivered to a public official pursuant to any applicable abandoned property, unclaimed property, escheat or similar Law. Any portion of the Merger Consideration remaining unclaimed by the Company Stockholders immediately prior to such time when the amounts would otherwise escheat to or become property of any Governmental Entity shall become, to the extent permitted by applicable Law, the property of DYNS free and clear of any claims or interest of any Person previously entitled thereto.

(j) At the Closing:

(i) DYNS shall deliver or cause to be delivered to the Company (A) the Investor Rights Agreement, duly executed by the stockholders of DYNS listed on Section 2.6(j)(i) of the DYNS Disclosure Schedules, and (B) the written resignations of all of the directors and officers of DYNS and Merger Sub (other than those Persons identified as directors of DYNS immediately after the Effective Time, in accordance with the provisions of Section 5.16), effective as of the Effective Time; and

(ii) the Company shall deliver or cause to be delivered to DYNS (A) the Investor Rights Agreement, duly executed by the Persons listed on Section 2.6(j)(ii) of the Company Disclosure Schedules, and (B) a duly executed certificate substantially in the form described in Treasury Regulations Section 1.1445-2(c)(3), together with a notice to the Internal Revenue Service in accordance with the provisions of Treasury Regulations Section 1.897-2(h)(2).

Section 2.7 *Withholding*. DYNS, the Exchange Agent and any of their Affiliates shall be entitled to deduct and withhold (or cause to be deducted and withheld) from any consideration payable pursuant to this Agreement such amounts as are required to be deducted and withheld under applicable Tax Law. To the extent that amounts are so withheld and remitted to the applicable Governmental Entity, such withheld amounts shall be treated for all purposes of this Agreement as having been paid to the Person in respect of which such deduction and withholding was made. Upon becoming aware of any such withholding obligation, DYNS shall use commercially reasonable efforts to give reasonable advance notice of such withholding to the Company (other than where such deduction or withholding is in respect of amounts treated as compensation under the Code or is due to a failure of a Person to provide an any applicable tax forms required under the Letter of Transmittal (or properly claim an exemption in respect of backup withholding on such tax forms)) and shall reasonably cooperate with the Company, to eliminate or reduce any such required deduction or withholding.

ARTICLE 3 REPRESENTATIONS AND WARRANTIES RELATING TO THE COMPANY

Subject to Section 8.8, except as set forth in the Company Disclosure Schedules, the Company hereby represents and warrants to the DYNS Parties, as of the date hereof and as of the Closing Date, as follows:

Section 3.1 Organization and Qualification.

(a) The Company and its Subsidiaries are corporations duly organized, validly existing and in good standing under the Laws of their jurisdiction of incorporation. The Company and its Subsidiaries have the requisite corporate power and authority to own, lease and operate their properties and to carry on the Business as presently conducted, except where the failure to have such power or authority would not, and would not reasonably be expected to, individually or in the aggregate, have a Company Material Adverse Effect.

(b) True and complete copies of the Governing Documents of the Company and its Subsidiaries have been made available to DYNS, in each case, as amended and in effect as of the date of this Agreement. The Governing Documents of the Company and its Subsidiaries are in full force and effect and neither the Company nor its Subsidiaries is in breach or violation of any provision set forth in its Governing Documents.

(c) The Company and its Subsidiaries are duly qualified or licensed to transact business and are in good standing (or the equivalent thereof, if applicable, in each case, with respect to the jurisdictions that recognize the concept of good standing or any equivalent thereof) in each jurisdiction in which the property and assets owned, leased or operated by them, or the nature of the business conducted by them, makes such qualification or licensing necessary, except where the failure to be so duly qualified or licensed and in good standing (or the equivalent thereof) would not, and would not reasonably be expected to, individually or in the aggregate, have a Company Material Adverse Effect.

Section 3.2 Capitalization.

(a) Schedule 3.2(a) of the Company Disclosure Schedules sets forth, as of the date of this Agreement, a true and complete statement of (i) the number and class or series (as applicable) of all of the Equity Securities of the Company issued and outstanding, (ii) the identity of the Persons that are the record and beneficial owners thereof (which does not include any Subsidiary of the Company), and (iii) with respect to each Company Option, (A) the date of grant, (B) any applicable exercise (or similar) price, (C) the expiration date, (D) any applicable vesting schedule (including acceleration provisions), (E) the number of shares of Company Common Stock subject to the Company Option on the date of grant, (F) the number of shares of Company Common Stock subject to the Company Option as of the date of this Agreement, and (G) whether the Company Option is an Incentive Stock Option. All of the Company Shares have been duly authorized and validly issued and are fully paid and non-assessable. The Company Shares (1) were not issued in violation of the Governing Documents of the Company or any other Contract to which the Company is party or bound, (2) were not issued in violation of any preemptive rights, call option, right of first refusal or first offer, subscription rights, transfer restrictions or similar rights of any Person, (3) have been offered, sold and issued in compliance with applicable Law, including Securities Laws, and (4) are free and clear of all Liens (other than transfer restrictions under applicable Securities Law). Except for the Company Options set forth on Section 3.2(a) of the Company Disclosure Schedules, as of the date of this Agreement, the Company has no outstanding (x) equity appreciation, phantom equity or profit participation rights, or (y) options, restricted stock, phantom stock, warrants, purchase rights, subscription rights, conversion rights, exchange rights, calls, puts, rights of first refusal or first offer or other Contracts, in the case of each of clause (x) and (y), that would require the Company to issue, sell or otherwise cause to become outstanding or to acquire, repurchase or redeem any Equity Securities or securities convertible into or exchangeable for Equity Securities of the Company or any of its Subsidiaries. There are no voting trusts, proxies or other Contracts with respect to the voting or transfer of the Company Shares. No Company Shares are held by a Subsidiary.

(b) Other than the Equity Securities it holds in each of its Subsidiaries, the Company does not own or hold (of record, beneficially, legally or otherwise), directly or indirectly, any Equity Securities in any other Person or the right to acquire any such Equity Securities, and the Company is not a partner or member of any partnership, limited liability company or joint venture.

(c) Section 3.2(c) of the Company Disclosure Schedules sets forth a list of all Indebtedness of the Company and its Subsidiaries as of the date of this Agreement, including the principal amount of such Indebtedness, the outstanding balance as of the date of this Agreement and the debtor and creditor thereof.

(d) Section 3.2(d) of the Company Disclosure Schedules sets forth a list of all Change of Control Payments of the Company and its Subsidiaries, identifying for each such Change of Control Payment (i) the Person eligible to receive such Change of Control Payment, (ii) the total potential amount of such Change of Control Payment, and (iii) the Contract or other arrangement pursuant to which such Change of Control Payment is payable or required to be made.

(e) Each Company Option was granted in compliance in all material respects with all applicable Laws and all of the terms and conditions of the applicable Company Equity Plan, and each Company Option has an exercise price per share that is equal to or greater than the fair market value of a share of Company Common Stock on the date of such grant, determined in a manner consistent with Section 409A of the Code.

Section 3.3 *Authority*. The Company has the requisite corporate power and authority to execute and deliver this Agreement and each Ancillary Document to which it is or will be a party, to perform its obligations hereunder and thereunder and to consummate the transactions contemplated hereby and thereby. Subject to obtaining the Company Stockholder Written Consent, the execution and delivery of this Agreement, the Ancillary Documents to which the Company is or will be a party and the consummation of the transactions contemplated hereby and thereby have been (or, in the case of any Ancillary Document entered into after the date of this Agreement, will be upon execution thereof) duly authorized by all necessary corporate action on the part of the Company. This Agreement and each Ancillary Document to which the Company is or will be a party has been or will be, upon execution thereof, as applicable, duly and validly executed and delivered by the Company and constitutes or will constitute, upon execution and delivery thereof, as applicable, a valid, legal and binding agreement of the Company (assuming that this Agreement and the Ancillary Documents to which the Company is or will be a party are or will be upon execution thereof, as applicable, duly authorized, executed and delivered by the other Persons party hereto or thereto, as applicable), enforceable against the Company in accordance with their terms, subject to applicable bankruptcy, insolvency, reorganization, moratorium or other Laws affecting generally the enforcement of creditors' rights and subject to general principles of equity ("**Enforceability Exceptions**").

Section 3.4 Subsidiaries.

(a) Set forth on Section 3.4(a) of the Company Disclosure Schedules is a list of the Company's Subsidiaries, together with their jurisdiction of incorporation, and a true and complete statement of the number and class or series (as applicable) of all of the Equity Securities of each Subsidiary.

(b) All of the issued share capital, stock or other voting or equity securities of each Subsidiary have been duly authorized and validly issued and are fully paid and non-assessable. All of the ownership interests in each Subsidiary are owned by the Company, directly or indirectly, free and clear of any Lien and free of any other limitation or restriction (including any restriction on the right to vote, sell or otherwise dispose of such ownership interests) and have not been issued in violation of preemptive or similar rights. There are no outstanding (i) subscriptions, calls, options, warrants, rights (including preemptive rights), puts or other securities of any Subsidiary convertible into or exchangeable or exercisable for shares or voting or equity securities of any Subsidiary, or any other Contracts to which the Company or any Subsidiary is a party or by which the Company or any Subsidiary is bound obligating the Company or any Subsidiary to issue or sell any shares of, other equity interests in or debt securities of, any Subsidiary, or (ii) equity equivalents, phantom stock, options, appreciation rights, stock units, profits interests or other rights to acquire from the Company or any Subsidiary, or other obligation of the Company or any Subsidiary to issue, any shares, voting or equity securities or securities convertible into or exchangeable for shares or voting or equity securities of any Subsidiary (the items in clauses (i) and (ii) being, collectively, “**Subsidiary Securities**”). There are no outstanding obligations of the Company or any Subsidiary to repurchase, redeem or otherwise acquire any outstanding Subsidiary Securities. None of the Subsidiaries owns any equity, ownership, profit, voting or similar interest in, or any interest convertible, exchangeable or exercisable for, any equity, profit, voting or similar interest in, any Person. No Subsidiary is party to any shareholders agreement, voting agreement, proxies, registration rights agreement or other similar agreements relating to its equity interests.

Section 3.5 Financial Statements; Undisclosed Liabilities.

(a) The Company has made available to DYNS true and complete copies of the audited consolidated balance sheets of the Company and its Subsidiaries as of December 31, 2019 and December 31, 2020 and the related audited consolidated statements of operations and comprehensive loss, redeemable convertible preferred stock and stockholders’ deficit and cash flows of the Company and its Subsidiaries for each of the years then ended (collectively, the “**Audited Company Financial Statements**”), and the unaudited, draft consolidated balance sheets of the Company as of September 30, 2021 and the related unaudited consolidated statements of operations of the Company and its Subsidiaries for the period then ended (the “**Unaudited Company Financial Statements**” and, together with the Audited Company Financial Statements, the “**Company Financial Statements**”). The Company Financial Statements (including the notes thereto) and, when delivered pursuant to Section 5.7, the Additional Company Financial Statements and any pro forma financial statements, (i) were prepared in accordance with GAAP applied on a consistent basis throughout the periods indicated (except as may be indicated in the notes thereto), (ii) fairly present, in all material respects, as applicable, the financial position, results of operations and cash flows of the Company and its Subsidiaries as at the date thereof and for the period indicated therein, except as otherwise specifically noted therein, (iii) in the case of the Audited Company Financial Statements and the Additional Company Financial Statements, when delivered pursuant to Section 5.7 only, were audited in accordance with the standards of the

PCAOB and contain an unqualified report of the Company's auditors, and (iv) comply in all material respects with the applicable accounting requirements and with the rules and regulations of the SEC, the Exchange Act and the Securities Act in effect as of the date hereof (including Regulation S-X or Regulation S-K, as applicable); *provided that*, the Unaudited Company Financial Statements do not include all of the notes or the information contained in such notes as required by GAAP for complete financial statements and are subject to normal year-end adjustments.

(b) Except (i) as set forth in the Company Financial Statements, (ii) for Liabilities incurred in the ordinary course of business as of December 31, 2020 (none of which is a Liability for breach of contract, breach of warranty, tort, infringement or violation of Law), (iii) for Liabilities incurred in connection with the negotiation, preparation or execution of this Agreement or any Ancillary Documents, the performance of the respective covenants or agreements in this Agreement or any Ancillary Document or the consummation of the transactions contemplated hereby or thereby, and (iv) for Liabilities that are not and would not reasonably be expected to be, individually or in the aggregate, material to the Company and its Subsidiaries, taken as a whole, the Company and its Subsidiaries have no Liabilities required by GAAP to be reflected or reserved against in the consolidated balance sheet as of December 31, 2020 included in the Company Financial Statements.

(c) The Company has established and maintains a system of internal accounting controls that is designed to provide, in all material respects, reasonable assurance that (i) all transactions are executed in accordance with management's authorization, and (ii) all transactions are recorded as necessary to permit preparation of proper and accurate financial statements in accordance with GAAP and to maintain accountability for the Company's and its Subsidiaries' assets.

(d) In the past three (3) years, neither the Company nor any of its Subsidiaries has received any written complaint, allegation, assertion or claim, written or otherwise, that there is (i) a "significant deficiency" in the internal controls over financial reporting of the Company and its Subsidiaries, (ii) a "material weakness" in the internal controls over financial reporting of the Company and its Subsidiaries, or (iii) fraud, whether or not material, that involves management or other employees of the Company or its Subsidiaries who have a significant role in the internal controls over financial reporting of the Company and its Subsidiaries.

Section 3.6 Consents and Requisite Governmental Approvals; No Violations.

(a) No consent, approval, waiver or authorization of, or designation, declaration or filing with, any Governmental Entity is required on the part of the Company with respect to the Company's execution, delivery or performance of its obligations under this Agreement or the Ancillary Documents to which the Company is or will be party or the consummation of the transactions contemplated hereby or thereby, except for (i) compliance with and filings under the HSR Act or any filings with or approvals or clearances from any Governmental Entities that the Parties determine (acting reasonably) are required and advisable to consummate the transactions contemplated hereby, (ii) the

filing with the SEC of (A) the Registration Statement/Proxy Statement and the declaration of the effectiveness thereof by the SEC, and (B) such reports under Section 13(a) or 15(d) of the Exchange Act as may be required in connection with this Agreement, the Ancillary Documents or the transactions contemplated hereby or thereby, (iii) filing of the Certificate of Merger, or (iv) any other consents, approvals, authorizations, designations, declarations, waivers or filings, the absence of which would not have a Company Material Adverse Effect.

(b) Neither the execution, delivery or performance by the Company of this Agreement nor the Ancillary Documents to which the Company is or will be a party, nor the consummation of the transactions contemplated hereby or thereby will, directly or indirectly (with or without due notice or lapse of time or both) (i) result in any breach of any provision of the Company's Governing Documents, (ii) result in a violation or breach of, or constitute a default or give rise to any right of termination, Consent, cancellation, amendment, modification, suspension, revocation or acceleration under, any of the terms, conditions or provisions of (A) any Material Contract to which the Company or any of its Subsidiaries is a party, or (B) any Material Permits, (iii) violate, or constitute a breach under, any Order or applicable Law to which the Company or any of its Subsidiaries or any of their respective properties or assets are bound, or (iv) result in the creation of any Lien upon any of the assets or properties (other than any Permitted Liens) or Equity Securities of the Company or any of its Subsidiaries, except, in the case of any of clauses (ii) through (iv) above, as would not be material to the Company and its Subsidiaries taken as a whole.

Section 3.7 *Permits*. The Company and its Subsidiaries have all Permits that are required to own, lease or operate their properties and assets and to conduct the Business as currently conducted, except where the failure to obtain the same would not result in a Company Material Adverse Effect (the "**Material Permits**"). Except as is not and would not reasonably be expected to be material to the Company and its Subsidiaries, taken as a whole, (a) each Material Permit is in full force and effect in accordance with its terms, and (b) no written notice of revocation, cancellation or termination of any Material Permit has been received by the Company or any of its Subsidiaries.

Section 3.8 Material Contracts.

(a) Section 3.8(a) of the Company Disclosure Schedules sets forth a list of the following Contracts to which the Company or any of its Subsidiaries is, as of the date of this Agreement, a party (each Contract required to be set forth on Section 3.8(a) of the Company Disclosure Schedules, together with each of the Contracts entered into after the date of this Agreement that would be required to be set forth on Section 3.8(a) of the Company Disclosure Schedules if entered into prior to the execution and delivery of this Agreement, collectively, the "**Material Contracts**"):

(i) any Contract relating to Indebtedness of the Company or any of its Subsidiaries or to the placing of a Lien (other than any Permitted Lien) on any material assets or properties of the Company or any of its Subsidiaries;

(ii) any Contract under which the Company or any of its Subsidiaries is lessee of or holds or operates, in each case, any tangible property (other than real property), owned by any other Person, except for any lease or agreement under which the aggregate annual rental payments do not exceed \$500,000;

(iii) any Contract under which the Company or any of its Subsidiaries is lessor of or permits any third party to hold or operate, in each case, any tangible property (other than real property), owned or controlled by the Company or any of its Subsidiaries, except for any lease or agreement under which the aggregate annual rental payments do not exceed \$500,000;

(iv) any Contract for any material joint venture, partnership, collaboration or strategic alliance;

(v) any Contract that (A) limits or purports to limit, in any material respect, the freedom of the Company or any of its Subsidiaries to engage or compete in any line of business or with any Person or in any area or that would so limit or purport to limit, in any material respect, the operations of DYNs or any of its Affiliates after the Closing, (B) contains any exclusivity, "most favored nation" or similar provisions, obligations or restrictions, or (C) contains any other provisions restricting or purporting to restrict the ability of the Company or any of its Subsidiaries to sell, manufacture, develop, commercialize, test or research the Company Products, directly or indirectly through third parties, in any material respect or that would so limit or purports to limit, in any material respect, DYNs or any of its Affiliates after the Closing;

(vi) any Contract requiring any future capital commitment or capital expenditure (or series of capital expenditures) by the Company or any of its Subsidiaries in an amount in excess of (A) \$500,000 annually, or (B) \$1,500,000 over the life of the agreement;

(vii) any Contract requiring the Company or any of its Subsidiaries to guarantee the Liabilities of any Person (other than the Company or a Subsidiary) or pursuant to which any Person (other than the Company or a Subsidiary) has guaranteed the Liabilities of the Company or any of its Subsidiaries, in each case in excess of \$500,000;

(viii) any Contract under which the Company or any of its Subsidiaries has, directly or indirectly, made or agreed to make any loan, advance, or assignment of payment to any Person or made any capital contribution to, or other investment in, any Person, in each case in excess of \$500,000;

(ix) any Contract required to be disclosed on Section 3.20 of the Company Disclosure Schedules;

(x) any Contract with any Person (A) pursuant to which the Company or any of its Subsidiaries (or DYNS or any of its Affiliates after the Closing) may be required to pay milestones, royalties or other contingent payments based on any research, testing, development, regulatory filings or approval, sale, distribution, commercial manufacture or other similar occurrences, developments, activities or events, in each case, relating to Company Products, or (B) under which the Company or any of its Subsidiaries grants to any Person any right of first refusal, right of first negotiation, option to purchase, option to license or any other similar rights with respect to any Company Product or any Company Business Intellectual Property;

(xi) any Contract (A) for the employment or engagement of any Key Employee of the Company or any of its Subsidiaries, or (B) providing for any Change of Control Payment of the type described in clause (a) of the definition thereof;

(xii) any Contract (A) executed with any current director, manager, officer, employee, Contingent Worker or other individual service provider of the Company or any of its Subsidiaries that provides for severance benefits, or (B) entered into by the Company or any of its Subsidiaries that constitutes a collective bargaining agreement or any other agreement executed between the Company or its Subsidiary, as applicable, and a union or similar organization;

(xiii) any Contract for the disposition of any portion of the assets or business of the Company or any of its Subsidiaries or for the acquisition by the Company or any of its Subsidiaries of the assets or business of any other Person (other than acquisitions or dispositions made in the ordinary course of business), or under which the Company or any of its Subsidiaries has any continuing obligation with respect to an "earn-out", contingent purchase price or other contingent or deferred payment obligation;

(xiv) any Contract pursuant to which the Company or any of its Subsidiaries (A) obtains any right to use, or covenant not to be sued under, any material Intellectual Property Right (other than any license for Off-the-Shelf Software), or (B) grants any right to use, or covenant not to be sued under, any material Intellectual Property Right.

(xv) any settlement, conciliation or similar Contract (A) the performance of which would be reasonably likely to involve any payments after the date of this Agreement by the Company or any of its Subsidiaries, (B) with a Governmental Entity or which relates to alleged criminal wrongdoing, (C) that imposes, at any time in the future, any material, non-monetary obligations on the Company or any of its Subsidiaries (or DYNS or any of its Affiliates after the Closing), or (D) which requires the Company or any of its Subsidiaries to accept or concede material injunctive relief; and

(xvi) any other Contract the performance of which requires either (A) annual payments by the Company or any of its Subsidiaries in excess of \$500,000, or (B) aggregate payments by the Company or any of its Subsidiaries in excess of \$1,500,000 over the life of the agreement and, in each case, that is not terminable by the Company or its Subsidiary, as applicable, without penalty upon less than thirty (30) days' prior written notice.

(b) (i) Each Material Contract is valid and binding on the Company or its Subsidiary, as applicable, and, to the knowledge of the Company, the counterparty thereto, and is in full force and effect, and (ii) the Company and its Subsidiaries and, to the knowledge of the Company, the counterparties thereto, are not in material breach of, or default under, any Material Contract, and, to the knowledge of the Company, there are no facts or circumstances which would, or which would reasonably be expected to, lead to such breach or default.

Section 3.9 *Absence of Changes*. During the period beginning on January 1, 2021 and ending on the date of this Agreement, (a) no Company Material Adverse Effect has occurred, and (b) except as expressly contemplated by this Agreement, any Ancillary Document or in connection with the transactions contemplated hereby and thereby, (i) the Company and its Subsidiaries have conducted the Business in the ordinary course in all material respects, and (ii) neither the Company nor any of its Subsidiaries has taken any action that would require the consent of DYNs if taken during the period from the date of this Agreement until the Closing pursuant to Section 5.1(b)(i), (ii), (iv), (v), (vii), (ix), (x) (solely relating to the Company's directors and officers), (xii), (xiv), (xv), (xviii) and (xxi).

Section 3.10 *Litigation*. There is (and for the past three (3) years there has been) (a) no Proceeding pending or, to the Company's knowledge, threatened against the Company, any of its Subsidiaries or any of their respective directors or officers, or affecting any of the Company's or its Subsidiaries' respective assets or properties, that if adversely decided or resolved, has been or would reasonably be expected to be, individually or in the aggregate, material to the Company and its Subsidiaries taken as a whole, and, to the Company's knowledge, no facts exist that would reasonably be expected to form the basis for any such Proceeding, (b) no material Order to which the Company, its Subsidiaries, their respective directors and officers or any of the Company's or its Subsidiaries' respective properties or assets is subject, (c) no Proceeding by the Company or any of its Subsidiaries against any other Person, and no such Proceeding is or has been threatened in writing, (d) no settlement or similar agreement that imposes any material ongoing obligation or restriction on the Company or any of its Subsidiaries or the operation of the Business, and (e) no pending or, to the Company's knowledge, threatened, audit, examination or investigation by any Governmental Entities set forth on Section 3.10 of the Company Disclosure Schedules in respect of the Company or any of its Subsidiaries or any of their respective properties or assets, or any of the directors or officers of the Company or any of its Subsidiaries.

Section 3.11 *Compliance with Applicable Law*. The Company and its Subsidiaries (a) conduct (and for the past three (3) years have conducted) the Business in accordance with all Laws and Orders applicable to them and are not in violation of any such Law or Order, and (b) have not received any written communications from a Governmental Entity and, to the Company's knowledge, there is no such pending communication, that alleges that the Company or any of its Subsidiaries is not in compliance with any such Law or Order, except in each case of clauses (a) and (b), as is not and would not reasonably be expected to be, individually or in the aggregate, material to the Company and its Subsidiaries taken as a whole.

Section 3.12 Employee Benefit Plans.

(a) Section 3.12(a) of the Company Disclosure Schedules sets forth a true and complete list of all material Employee Benefit Plans.

(b) True, complete and correct copies of the following documents, with respect to each Employee Benefit Plan, where applicable, have been delivered to DYNS (i) all documents embodying or governing such Employee Benefit Plan (or for unwritten Employee Benefit Plans, a written description of the material terms of such Employee Benefit Plan) and any funding medium for the Employee Benefit Plan, (ii) the most recent Internal Revenue Service determination or opinion letter, (iii) the most recently filed Form 5500, (iv) the most recent actuarial valuation report, (v) the most recent summary plan description (or other descriptions provided to employees) and all modifications thereto, (vi) the last three (3) years of non-discrimination testing results, and (vii) all non-routine correspondence to and from any Governmental Entity.

(c) Each Employee Benefit Plan that is intended to be qualified under Section 401(a) of the Code has received a favorable determination or approval letter from the Internal Revenue Service with respect to such qualification, or may rely on an opinion letter issued by the Internal Revenue Service with respect to a prototype plan adopted in accordance with the requirements for such reliance and, to the knowledge of the Company, no event or omission has occurred that would be reasonably likely to cause any such Employee Benefit Plan to lose such qualification or otherwise require corrective action under the Internal Revenue Service Employee Plan Compliance Resolution System to maintain such qualification. Each trust created under any such Employee Benefit Plan is exempt from Tax under Section 501(a) of the Code and has been so exempt since its creation.

(d) Each Employee Benefit Plan is and has been established, operated and administered in all material respects in accordance with applicable Laws and with its terms, including ERISA, the Code and the Affordable Care Act. No Employee Benefit Plan is, or within the past six (6) years has been, the subject of an application or filing under a government sponsored amnesty, voluntary compliance or similar program, or been the subject of any self-correction under any such program. No litigation or governmental administrative proceeding, audit or other proceeding (other than those relating to routine claims for benefits) is pending or, to the knowledge of the Company, threatened with respect to any Employee Benefit Plan. All payments or contributions required to have been made with respect to all Employee Benefit Plans either have been made or have been accrued in accordance with the terms of the applicable Employee Benefit Plan and applicable Law.

(e) Neither the Company, its Subsidiaries nor any ERISA Affiliate (or any predecessor thereof) has ever maintained, contributed to, or been required to contribute to or had any liability (whether contingent or otherwise) or obligation (including on account of any ERISA Affiliate) with respect to (i) any Employee Benefit Plan that is or was subject to Title IV of ERISA, Section 412 of the Code or Section 302 of ERISA, (ii) a “multiemployer plan” (within the meaning of Section (3)37 of ERISA), (iii) any funded welfare benefit plan within the meaning of Section 419 of the Code, (iv) any “multiple employer plan” (within the meaning of Section 210 of ERISA or Section 413(c) of the Code), or (v) any “multiple employer welfare arrangement” (as such term is defined in Section 3(40) of ERISA).

(f) No Employee Benefit Plan provides health care or any other non-pension benefits to any employees after their employment is terminated (other than (i) as required by Part 6 of Subtitle B of Title I of ERISA, Section 4980B of the Code and any similar state Law, (ii) continuation of health or life insurance benefits provided during any severance period not in excess of two (2) years, or (iii) which lasts until the end of the month in which the termination of employment occurs).

(g) Each Employee Benefit Plan that constitutes in any part a nonqualified deferred compensation plan within the meaning of Section 409A of the Code has been operated and maintained in all material respects in operational and documentary compliance with Section 409A of the Code and applicable guidance thereunder. No payment to be made under any Employee Benefit Plan is, or to the Company’s knowledge will be, subject to the penalties of Section 409A(a)(1) of the Code.

(h) Except as set forth on Section 3.12(h) of the Company Disclosure Schedules, neither the execution or delivery of this Agreement or any Ancillary Document to which the Company is or will be a party, the Company Stockholder Written Consent nor the consummation of the transactions contemplated by this Agreement or any Ancillary Document to which the Company is or will be a party, would (either alone or in combination with any other event) reasonably be expected to (i) result in, or cause the accelerated vesting, payment, funding or delivery of, or increase the amount or value of, any payment or benefit to any current or former director, manager, officer, employee, individual independent contractor or other individual service provider of the Company or any of its Subsidiaries, (ii) further restrict any rights of the Company or its Subsidiaries to merge, amend or terminate any Employee Benefit Plan, or (iii) result in any “parachute payment” as defined in Section 280G(b)(2) of the Code.

(i) Neither the Company nor any of its Subsidiaries has any obligation to make any tax “gross-up” or similar “make whole” payments to any service provider.

(j) No Employee Benefit Plan is subject to the laws of any jurisdiction outside the United States.

Section 3.13 *Environmental Matters*. Except as would not have a Company Material Adverse Effect:

(a) Neither the Company nor any of its Subsidiaries has received any written notice or communication from any Governmental Entity or any other Person regarding any actual, alleged or potential violation in any respect of, or a failure to comply in any respect with, any Environmental Laws.

(b) There is (and for the past three (3) years there has been) no Proceeding pending or, to the Company's knowledge, threatened against the Company, any of its Subsidiaries or any of their respective directors and officers pursuant to Environmental Laws.

(c) There has not been, whether by the Company or any of its Subsidiaries, any manufacture, release, treatment, storage, disposal, arrangement for disposal, transport or handling of, contamination by, or exposure of any Person to, any hazardous, toxic, explosive or radioactive material, substance, waste or other pollutant that is regulated by, or may give rise to Liability pursuant to any Environmental Law, including any petroleum products or byproducts, asbestos, lead, polychlorinated biphenyls, per- and poly-fluoroalkyl substances, or radon.

(d) The Company has made available to DYNs copies of all material environmental, health and safety reports and documents that were prepared for the Company or its Subsidiaries by third parties and are in the Company's or its Subsidiaries' possession relating to the operations, properties or facilities of the Company and its Subsidiaries in the past three (3) years.

Section 3.14 Intellectual Property.

(a) Section 3.14(a) of the Company Disclosure Schedules sets forth a true and complete list of (i) all currently issued or pending Company Registered Intellectual Property, and (ii) any Patent included in the Company Licensed Intellectual Property that is exclusively licensed to the Company or any of its Subsidiaries ("**Licensed Patents**"), specifying as to each such item, as applicable, (A) the record owner of such item, (B) the jurisdictions in which such item has been issued, registered or filed, (C) the issuance, registration or application date, as applicable, for such item, and (D) the issuance, registration or application number, as applicable, for such item.

(b) All fees and filings necessary as of the date of this Agreement to maintain any application or registration, issuance or grant of any Company Registered Intellectual Property and, to the Company's knowledge, any Licensed Patents, have been timely submitted to the relevant intellectual property office or Governmental Entity and Internet domain name registrars, as applicable. No item of the Company Registered Intellectual Property or, to the Company's knowledge, Licensed Patents are cancelled. As of the date of this Agreement, the Company Registered Intellectual Property and, to the Company's knowledge, Licensed Patents are not the subject of any pending Proceedings, including litigation, interference, re-examination, *inter partes* review, reissue, opposition, nullity or cancellation proceedings and, to the Company's knowledge, no such Proceedings are threatened by any Governmental Entity or any other Person.

(c) Except as set forth in Section 3.14(c) of the Company Disclosure Schedules, the Company and its Subsidiaries exclusively own all right, title and interest in and to all Company Owned Intellectual Property, free and clear of all Liens (other than Permitted Liens) and hold all right, title and interest in and to all of the Company's or its applicable Subsidiary's rights under all Company Licensed Intellectual Property free and clear of any Lien (other than Permitted Liens). For all Patents included in the Company Owned Intellectual Property, each inventor listed on the Patent has assigned his or her rights to the Company or the relevant Subsidiary.

(d) The Company Business Intellectual Property, to the Company's knowledge, constitutes all of the Intellectual Property Rights that are necessary to enable the Company and its Subsidiaries to conduct the Business as currently conducted. To the knowledge of the Company, the Company Registered Intellectual Property and Licensed Patents are currently in compliance with formal legal requirements of the applicable intellectual property office and are not subject to any maintenance fees or taxes or actions falling due within 90 days after the Closing Date, with the exception of responses, patent maintenance fees, and other filings due in the ordinary course of intellectual property prosecution with the applicable intellectual property offices. All Company Registered Intellectual Property and, to the knowledge of the Company, Licensed Patents are subsisting, and if registered, issued or granted, are valid and enforceable.

(e) The Company's and its Subsidiaries' employees, consultants, advisors and independent contractors who independently or jointly contributed to or otherwise participated in the authorship, invention, creation, improvement, modification or development of any Intellectual Property Rights on behalf of the Company (each such person, a "Creator") have assigned to the Company or its relevant Subsidiary, as applicable, all Intellectual Property Rights authored, invented, created, improved, modified or developed by such person in the course of such Creator's employment or other engagement with the Company or any of its Subsidiaries.

(f) The Company and its Subsidiaries have taken reasonable steps to safeguard and maintain the secrecy of any trade secrets, confidential know-how and other confidential information owned by or licensed to the Company and its Subsidiaries. Without limiting the foregoing, the Company and its Subsidiaries have not disclosed any material trade secrets, confidential know-how or confidential information to any other Person unless such disclosure was under an appropriate written non-disclosure agreement containing appropriate limitations on use, reproduction and disclosure or was otherwise made subject to an appropriate duty of confidence. To the Company's knowledge, there has been no violation or unauthorized access to or disclosure of any material trade secrets, confidential know-how or confidential information of or in the possession of the Company or any of its Subsidiaries, or of any written obligations with respect to such.

(g) None of the Company Owned Intellectual Property and, to the Company's knowledge, none of the Company Licensed Intellectual Property is subject to any outstanding Order that restricts in any manner the use, sale, transfer, licensing or exploitation thereof by the Company and its Subsidiaries or affects the validity, use or enforceability of any such Company Business Intellectual Property. The consummation of the transactions contemplated by this Agreement will not alter, encumber, impair or extinguish any Company Owned Intellectual Property or the Company's or its applicable Subsidiary's rights under any Company Licensed Intellectual Property.

(h) To the Company's knowledge, neither the Company nor its Subsidiaries nor any actual or currently contemplated design, development, manufacturing, reproduction, use, marketing, offer for sale, sale, importation, exportation, distribution or other exploitation of any Company Product infringes, misappropriates or otherwise violates any valid, enforceable claim of any Patents or other Intellectual Property Rights of any other Person, except as is not and would not reasonably be expected to be, individually or in the aggregate, material to the Company and its Subsidiaries taken as a whole.

(i) In the past three (3) years, there has been no Proceeding pending against the Company or any of its Subsidiaries nor has the Company or any of its Subsidiaries received any written communications (i) alleging that the Company or any of its Subsidiaries has infringed, misappropriated or otherwise violated any Intellectual Property Rights of any other Person, (ii) challenging the validity, enforceability, use or exclusive ownership of any Company Owned Intellectual Property, or (iii) inviting the Company or any of its Subsidiaries to take a license under any Patent or consider the applicability of any Patents to any products or services of the Company or any of its Subsidiaries or to the conduct of the Business.

(j) To the Company's knowledge, no Person is infringing, misappropriating or otherwise violating any Company Business Intellectual Property. For the past three (3) years, neither the Company nor any of its Subsidiaries has made any claim against any Person alleging any infringement, misappropriation or other violation of any Company Business Intellectual Property.

(k) The Company and its Subsidiaries own or have obtained, possess and are in compliance with valid licenses to use all of the Software present on the computers and other Software-enabled electronic devices that they own or lease or that are otherwise under the control of the Company and its Subsidiaries and used by them in connection with the Business, except as is not and would not reasonably be expected to be, individually or in the aggregate, material to the Company and its Subsidiaries taken as a whole.

(l) Section 3.14(a) of the Company Disclosure Schedules contains a true and complete list of any and all Company Business Intellectual Property that was created, developed or reduced to practice, or is being created, developed or reduced to practice, (i) pursuant to, or in connection with, any Contract with any Governmental Entity or Governmental Entity-affiliated entity, or university, college or other educational institution, or (ii) using any funding or facilities of any Governmental Entity or Governmental Entity-affiliated entity, or university, college or other educational institution (collectively, "**Government Funded IP**"). Except as is not and would not reasonably be expected to be, individually or in the aggregate, material to the Company and its Subsidiaries taken as a whole, the Company and its Subsidiaries, and to the Company's knowledge, the applicable licensors of Company Licensed Intellectual Property, have taken any and all actions necessary to obtain, secure, maintain, enforce

and protect the Company's or its applicable Subsidiary's right, title and interest in, to and under all Government Funded IP, and the Company and its Subsidiaries, and to the Company's knowledge the applicable licensors of Company Licensed Intellectual Property, have complied with any and all any Intellectual Property Rights disclosure and/or licensing obligations under any applicable contract referenced in clause (i) above.

Section 3.15 Labor Matters.

(a) Section 3.15(a) of the Company Disclosure Schedules contains a complete and accurate list of all employees of the Company and its Subsidiaries as of the date of this Agreement, setting forth for each employee (i) the employee's position or title, (ii) the entity that employs the individual, (iii) whether classified as exempt or non-exempt for wage and hour purposes, (iv) whether paid on a salary, hourly or commission basis, (v) the employee's actual annual base salary (if paid on a salary basis), hourly rate (if paid on an hourly basis) or commission rate (if paid on a purely commission basis), as applicable, (vi) bonus and commission potential, (vii) for any part-time employee, average scheduled hours per week, (viii) date of hire, (ix) business location, (x) status (*i.e.*, active or inactive and if inactive, the type of leave and estimated duration), and (xi) any visa or work permit status and the date of expiration, if applicable.

(b) The Company and its Subsidiaries are and for at least the past three (3) years have been in material compliance with the Fair Labor Standards Act and state, local and foreign wage and hour Laws (as applicable) regarding proper classification of its employees as exempt or non-exempt. With respect to Contingent Workers who are or were engaged by the Company, the Company and its Subsidiaries are and for at least the past three (3) years have been in material compliance with applicable Laws regarding proper classification and treatment of services providers as Contingent Workers (as distinguished from Form W-2 employees).

(c) The Company and its Subsidiaries are, and for the past three (3) years have been, in compliance in all material respects with all applicable Laws and regulations respecting labor and employment matters, including fair employment practices, pay equity, the classification of independent contractors, workplace safety and health, work authorization and immigration, unemployment compensation, workers' compensation, affirmative action, terms and conditions of employment, employee leave and wages and hours, including payment of minimum wages and overtime. The Company and its Subsidiaries are not delinquent in any payments to any employee or Contingent Worker for any wages, salaries, commissions, bonuses, severance, fees or other direct compensation, as applicable, due with respect to any services performed for it or amounts required to be reimbursed to such employees or Contingent Workers. The Company and its Subsidiaries are not liable for any employment taxes or any payment to any trust or other fund governed by or maintained by or on behalf of any Governmental Entity with respect to unemployment compensation benefits, social security or other benefits or obligations for employees (other than routine payments to be made in the normal course of business and consistent with past practice).

(d) Currently and within the three (3) years preceding the date of this Agreement, the Company and its Subsidiaries have not been party to or, to the Company's knowledge, the subject of any litigation, arbitration, mediation, governmental audit, administrative agency proceeding, private dispute resolution proceeding or governmental investigation, in each case relating to employment or labor matters concerning the employees or Contingent Workers of the Company and its Subsidiaries, and the Company and its Subsidiaries have not conducted an internal investigation or authorized a third-party investigation (including those concerning allegations of employment discrimination, retaliation, noncompliance with wage and hour Laws, the misclassification of independent contractors, violation of restrictive covenants, sexual harassment or misconduct, other unlawful harassment, or unfair labor practices), and no such matters are pending or, to the knowledge of the Company, have been threatened against the Company or any of its Subsidiaries.

(e) In the past three (3) years, the Company and its Subsidiaries have not experienced a "plant closing," "business closing," or "mass layoff" or similar group employment loss as defined in the federal WARN Act or any similar state, local or foreign Law affecting any site of employment of the Company or its Subsidiaries or one or more facilities or operating units within any site of employment or facility of the Company or its Subsidiaries. During the ninety (90) day period preceding the date of this Agreement, no employee has suffered an "employment loss" as defined in the WARN Act with respect to the Company or its Subsidiaries. The Company and its Subsidiaries have not incurred any material Liability under the WARN Act nor will they incur any Liability under the WARN Act as a result of the transactions contemplated by this Agreement or the Ancillary Documents to which the Company is or will be a party.

(f) The Company and its Subsidiaries are not a party to or bound by any collective bargaining agreements or other agreements with any labor organization, labor union, works council or other employee representative or any other Contract with a labor union, labor organization, works council, employee delegate, representative or other employee collective group, nor to the knowledge of the Company is there any duty on the part of the Company or any of its Subsidiaries to bargain with any labor union, labor organization, works council, employee delegate, representative or other employee collective group. For the past three (3) years, there has been no actual or, to the Company's knowledge, threatened unfair labor practice charges, material grievances, arbitrations, strikes, lockouts, work stoppages, slowdowns, picketing, hand billing or other material labor disputes against the Company or any of its Subsidiaries. To the Company's knowledge, for the past three (3) years, there have been no labor organizing activities with respect to any employees of the Company or any of its Subsidiaries.

(g) No employee layoff, facility closure or shutdown (whether voluntary or by Order), reduction-in-force, furlough, temporary layoff, material work schedule change, reduction in hours, or reduction in salary or wages by the Company or any of its Subsidiaries has occurred within the six (6) months prior to the date of this Agreement or has been announced as of the date of this Agreement as a result of COVID-19 or any Law, Order, directive, guidelines or recommendations by any Governmental Entity in connection with or in response to COVID-19. The Company and its Subsidiaries are and have been in material compliance with all applicable employment-related Pandemic Measures of a type described in clause (i) of the definition thereof.

(h) Except as set forth in Section 3.15(h) of the Company Disclosure Schedules, to the knowledge of the Company, no Key Employee has expressed, as of the date of this Agreement, any plans to terminate his or her employment with such entity.

(i) Except as set forth in Section 3.15(i) of the Company Disclosure Schedules, each employee of the Company and its Subsidiaries is employed at will.

(j) In the last five (5) years, no allegations of sexual harassment or sexual misconduct have been made to the Company or any of its Subsidiaries against any officer, executive or management-level employee of the Company or any of its Subsidiaries and, to the Company's knowledge, there have not been any such allegations.

(k) During the three (3) year period preceding the date hereof, the Company and its Subsidiaries have paid and continue to pay each of their employees in a manner that complies in all material respects with applicable federal, state and local Laws pertaining to the equal pay of employees.

(l) Currently, and within the three (3) years preceding the date of this Agreement, the Company and its Subsidiaries have complied in all material respects with all applicable Laws concerning affirmative action and prevailing wage obligations.

Section 3.16 *Insurance*. Section 3.16 of the Company Disclosure Schedules sets forth a list of all material policies of fire, liability, workers' compensation, property, casualty and other forms of material insurance owned or held by the Company or its Subsidiaries as of the date of this Agreement. All such policies are in full force and effect, all premiums due and payable thereon as of the date of this Agreement have been paid in full as of the date of this Agreement and true and complete copies of all such policies have been made available to DYNs. Neither the Company nor any of its Subsidiaries is in breach or otherwise in default under the terms of such policies and, to the Company's knowledge, no facts or circumstances exist which would result in any such breach or default, in each case, which has voided, would void, or which might reasonably be expected to void, any coverages under such policies. As of the date of this Agreement, no claim by the Company or any of its Subsidiaries is pending under any such policies as to which coverage has been questioned, denied or disputed, or rights reserved to do so, by the underwriters thereof, except as is not and would not reasonably be expected to be, individually or in the aggregate, material to the Company and its Subsidiaries, taken as a whole. To the Company's knowledge, the coverages provided by such policies are usual and customary in amount and scope for the Business as currently conducted and sufficient to comply with any insurance required to be maintained under Material Contracts.

Section 3.17 Tax Matters.

(a) The Company and its Subsidiaries have prepared and filed all material Tax Returns required to have been filed by them, all such Tax Returns are true and complete in all material respects and prepared in compliance in all material respects with all applicable Laws and Orders, and the Company and its Subsidiaries have paid all material Taxes required to have been paid by them regardless of whether shown on a Tax Return.

(b) The Company and its Subsidiaries have timely withheld and paid to the appropriate Tax Authority all material amounts required to have been withheld and paid in connection with amounts paid or owing to any employee, individual independent contractor, other service provider, equity interest holder or other third-party.

(c) The Company and its Subsidiaries are not currently the subject of a Tax audit or examination, and have not been informed in writing of the commencement or anticipated commencement of any Tax audit or examination that has not been resolved or completed, in each case, with respect to material Taxes.

(d) The Company and its Subsidiaries have not consented to extend or waive the time in which any material Tax may be assessed or collected by any Tax Authority, other than any such extensions or waivers that are no longer in effect or that were extensions of time to file Tax Returns obtained in the ordinary course of business.

(e) No "closing agreement" as described in Section 7121 of the Code (or any corresponding or similar provision of state, local or non-U.S. income Tax Law), private letter ruling, technical advice memoranda or similar agreement or ruling has been entered into or issued by any Tax Authority with respect to the Company or any of its Subsidiaries which agreement or ruling would be effective after the Closing Date.

(f) The Company and its Subsidiaries are not nor have they been a party to any "listed transaction" as defined in Section 6707A of the Code and Treasury Regulations Section 1.6011-4 (or any corresponding or similar provision of state, local or non-U.S. income Tax Law).

(g) There are no Liens for Taxes on any assets of the Company or its Subsidiaries other than Permitted Liens.

(h) Neither the Company nor any of its Subsidiaries has been a distributing corporation or a controlled corporation in a transaction purported or intended to be governed by Section 355 of the Code.

(i) Neither the Company nor any of its Subsidiaries (i) has been a member of an affiliated group filing a consolidated federal income Tax Return (other than a group the common parent of which was the Company), or (ii) has any material Liability for the Taxes of any Person (other than the Company or any of its Subsidiaries, as applicable) under Section 1.1502-6 of the Treasury Regulations (or any similar provision of state, local or non-U.S. Law), as a transferee or successor, by Contract or otherwise (other than any Contract entered into in the ordinary course of business, the principal purpose of which does not relate to Taxes).

(j) No written claims have ever been made by any Tax Authority in a jurisdiction where the Company and its Subsidiaries do not file a particular type of Tax Return or pay a particular type of Tax that the Company or any of its Subsidiaries is or may be required to file such type of Tax Return in or pay such type of Tax to that jurisdiction, which claims have not been resolved or withdrawn.

(k) Neither the Company nor any of its Subsidiaries is a party to any Tax allocation, Tax sharing or Tax indemnity or similar agreement (other than one that is included in a Contract entered into in the ordinary course of business that is not primarily related to Taxes) and neither the Company nor any of its Subsidiaries is a party to any joint venture, partnership or other arrangement that is treated as a partnership for U.S. federal income Tax purposes.

(l) The Company and its Subsidiaries are tax residents only in their respective jurisdiction of formation, and are not managed or controlled outside such jurisdiction for income Tax purposes.

(m) Neither the Company nor any of its Subsidiaries has a branch, permanent establishment (within the meaning of an applicable Tax treaty) or otherwise has an office or fixed place of business in a country other than the country in which it is organized.

(n) Neither the Company nor any of its Subsidiaries will be required to include any item of income in, or exclude any item of deduction from, taxable income for any taxable period (or portion thereof) ending after the Closing Date as a result of any: (i) change in, or use of improper, method of accounting for a taxable period ending on or prior to the Closing Date, (ii) "closing agreement" as described in Section 7121 of the Code (or any corresponding or similar provision of state, local or foreign income Tax Law) executed on or prior to the Closing Date, (iii) installment sale or open transaction disposition made on or prior to the Closing Date, (iv) prepaid amount received on or prior to the Closing Date outside of the ordinary course of Business, (v) intercompany transaction or excess loss amount described in Treasury Regulations under Section 1502 of the Code (or any corresponding or similar provision of state, local or foreign income Tax Law), or (vi) election under Section 965(h) of the Code.

(o) Neither the Company nor any of its Subsidiaries has deferred any Taxes under Section 2302 of the Coronavirus Aid, Relief and Economic Security Act of 2020 (the "CARES Act").

(p) All related party transactions involving the Company or any of its Subsidiaries are at arm's length in compliance with Section 482 of the Code, the Treasury Regulations promulgated thereunder and any similar provision of state, local or non-U.S. Law.

(q) Neither the Company nor any of its Subsidiaries (i) knows of any fact or circumstance, or (ii) has taken or agreed to take any action not contemplated by this Agreement or any Ancillary Document, in each case, that would reasonably be expected to prevent the Merger from qualifying for the Intended Tax Treatment.

Section 3.18 *Brokers*. Except for fees (including the amounts due and payable assuming the Closing occurs) set forth on Section 3.18 of the Company Disclosure Schedules (which fees shall be the sole responsibility of the Company, except as otherwise provided in Section 8.6), no broker, finder, investment banker or other Person is entitled to any brokerage fee, finder's fee or other commission in connection with the transactions contemplated by this Agreement based upon arrangements made by or on behalf of the Company, any of its Subsidiaries or any of their respective Affiliates for which the Company or its Subsidiaries has any obligation.

Section 3.19 *Real and Personal Property*.

(a) *Owned Real Property*. The Company does not own any real property.

(b) *Leased Real Property*. Section 3.19(b) of the Company Disclosure Schedules sets forth a true and complete list (including street addresses) of all real property leased by the Company and its Subsidiaries (the "**Leased Real Property**") and all Real Property Leases pursuant to which the Company or any of its Subsidiaries is a tenant or landlord as of the date of this Agreement. True and complete copies of all such Real Property Leases have been made available to DYNs. Each Real Property Lease is in full force and effect and is a valid, legal and binding obligation of the Company or its Subsidiary (as applicable), enforceable in accordance with its terms against the Company or its Subsidiary (as applicable) and, to the Company's knowledge, each other party thereto, subject to the Enforceability Exceptions. There is no material breach or default by the Company or its Subsidiary (as applicable) or, to the Company's knowledge, any third party under any Real Property Lease.

(c) *Personal Property*. The Company and its Subsidiaries have good, valid and indefeasible title to, or a valid leasehold interest in or license or right to use, all of the material tangible assets and properties of the Company and its Subsidiaries reflected in the Company Financial Statements or thereafter acquired by the Company or any of its Subsidiaries prior to the date hereof, except for assets disposed of in the ordinary course of business.

Section 3.20 *Transactions with Affiliates*. Section 3.20 of the Company Disclosure Schedules sets forth all Contracts between (a) the Company or any of its Subsidiaries, on the one hand, and (b) any officer, director, employee, equityholder or Affiliate of the Company or any of its Subsidiaries, or any family member of the foregoing Persons, on the other hand (each Person identified in this clause (b), a "**Company Related Party**"), other than (i) Contracts with respect to a Company Related Party's employment with or service as a director to (including benefit plans and other ordinary course compensation from) the Company or any of its Subsidiaries entered into in the ordinary course of business, and (ii) Contracts entered into after the date of this Agreement that are either permitted pursuant to Section 5.1(b) or entered into in accordance with Section 5.1(b). No Company Related Party (A) owns any interest in any material asset used in the Business, (B) possesses, directly or indirectly, any material financial interest in, or is a director or executive officer of, any Person which is a supplier, lender, partner, lessor, lessee or other material business relation of the Company or any of its Subsidiaries, or (C) owes any material amount to, or is owed any material amount by, the Company or any of its Subsidiaries (other than ordinary course accrued

compensation, employee benefits, employee or director expense reimbursement or other transactions entered into after the date of this Agreement that are either permitted pursuant to Section 5.1(b) or entered into in accordance with Section 5.1(b)). All Contracts, arrangements, understandings, interests and other matters that are required to be disclosed pursuant to this Section 3.20 are referred to herein as “**Company Related Party Transactions**”.

Section 3.21 Data Privacy and Security.

(a) The Company and its Subsidiaries have at all times for the past three (3) years complied in all material respects with all applicable Privacy Laws, Privacy and Data Security Policies (as defined below) and contractual commitments relating to the Processing of Personal Data (collectively, the “**Privacy Requirements**”). The Company has implemented adequate written policies relating to the Processing of Personal Data as and to the extent required by applicable Law (“**Privacy and Data Security Policies**”).

(b) There is no pending, nor has there been for the past three (3) years, any Proceeding against the Company or any of its Subsidiaries initiated by (i) any Person, (ii) the United States Federal Trade Commission, any state attorney general or similar state official, (iii) any other Governmental Entity, foreign or domestic, or (iv) any regulatory or self-regulatory entity, alleging that any Processing of Personal Data by or on behalf of the Company or any of its Subsidiaries is in violation of any Privacy Requirements.

(c) For the past three (3) years, there has been no breach of security resulting in unauthorized access, use or disclosure of Personal Data in the possession or control of the Company or any of its Subsidiaries or, to the Company’s knowledge, any of its contractors with regard to any Personal Data obtained from or on behalf of the Company or any of its Subsidiaries, or any unauthorized intrusions or breaches of security into the Company’s or its Subsidiaries’ systems.

(d) The Company and its Subsidiaries own or have license to use the Company IT Systems as necessary to operate the Business as currently conducted and the Company IT Systems operate and perform in a manner that permits the Company and its Subsidiaries to conduct the Business as currently conducted. To the Company’s knowledge, none of the Company IT Systems contain any worm, bomb, backdoor, clock, timer or other disabling device, code, design or routine that causes the Software of any portion thereof to be erased, inoperable or otherwise incapable of being used, either automatically, with the passage of time or upon command by any unauthorized person.

(e) The Company has taken commercially reasonable organizational, physical, administrative and technical measures required by Privacy Requirements, and consistent with standards prudent in the industry in which the Company operates, designed to protect the integrity, security and operations of the Company IT Systems. The Company and its Subsidiaries have implemented commercially reasonable procedures, satisfying the requirements of applicable Privacy Laws in all material respects, designed to detect data security incidents and to protect Personal Data against loss and against unauthorized access, use, modification, disclosure or other misuse.

(f) The consummation of any of the transactions contemplated hereby or pursuant to any Ancillary Document will not violate any applicable Privacy Requirements.

(g) There have not been any Proceedings related to any data security incidents or any violations of any Privacy Requirements that have been asserted against the Company or any of its Subsidiaries and, to the Company's knowledge, neither the Company nor any of its Subsidiaries has received any information relating to, or notice of any Proceedings with respect to, alleged violations by the Company or any of its Subsidiaries of any Privacy Requirements.

Section 3.22 Compliance with International Trade & Anti-Corruption Laws.

(a) Neither the Company nor any of its Subsidiaries nor, to the Company's knowledge, any of their respective Representatives acting for or on their behalf, is or has been, for the past three (3) years (i) a Person named on any Sanctions and Export Control Laws-related list of designated Persons maintained by a Governmental Entity, (ii) located, organized or resident in a country or territory which is itself the subject or target of any Sanctions and Export Control Laws, (iii) an entity owned, directly or indirectly, by one or more Persons described in clause (i) or (ii), or (iv) otherwise engaging in dealings with or for the benefit of any Person described in clauses (i) through (iii) or any country or territory which is or has, or the past three (3) years, been the subject or target of any Sanctions and Export Control Laws (at the time of this Agreement, the Crimea region of Ukraine, Cuba, Iran, North Korea, Venezuela, Sudan and Syria).

(b) Neither the Company nor any of its Subsidiaries nor, to the Company's knowledge, any of their respective Representatives acting for or on their behalf, has (i) made, offered, promised, paid or received any unlawful bribes, kickbacks or other similar payments to or from any Person, or (ii) otherwise violated any Anti-Corruption Laws.

Section 3.23 *Information Supplied*. None of the information supplied or to be supplied by or on behalf of the Company expressly for inclusion or incorporation by reference prior to the Closing in the Registration Statement/Proxy Statement will, when the Registration Statement/Proxy Statement is declared effective, when the Registration Statement/Proxy Statement is mailed to the Pre-Closing DYNs Stockholders, or at the time of the DYNs Stockholders Meeting, and in the case of any amendment thereto, at the time of such amendment, contain any untrue statement of a material fact or omit to state any material fact required to be stated therein or necessary in order to make the statements therein, in light of the circumstances under which they are made, not misleading.

Section 3.24 Regulatory Compliance.

(a) The Company, its Subsidiaries and the Company Products are in compliance in all material respects with all Regulatory Permits, if any. To the knowledge of the Company, (i) no Governmental Entity is considering limiting, suspending or revoking any Regulatory Permit held by the Company or any of its Subsidiaries, if any, and (ii) each third party that is a manufacturer, contractor or agent for the Company or any of its Subsidiaries is in compliance in all material respects with all Regulatory Permits, if any, required by all applicable Healthcare Laws insofar as they reasonably pertain to the Company Products.

(b) Neither the Company nor any of its Subsidiaries has, nor, to the Company's knowledge, have any of their Representatives acting on their behalf, received any written notice that the FDA or any other Governmental Entity responsible for oversight or enforcement of any applicable Healthcare Law, or any institutional review board (or similar body responsible for oversight of human subjects research) or institutional animal care and use committee (or similar body responsible for oversight of animal research), has initiated, or threatened to initiate, any Proceeding to restrict or suspend preclinical or nonclinical research on or clinical study of any Company Product or in which the Governmental Entity alleges or asserts a failure to comply with applicable Healthcare Laws.

(c) There are no Proceedings pending or, to the Company's knowledge, threatened, with respect to any alleged violation by the Company or any of its Subsidiaries or, to the Company's knowledge, any of their Representatives acting for or on their behalf, of the United States Federal Food, Drug, and Cosmetic Act (the "FDCA") or any other applicable Healthcare Law as it relates to a Company Product, and neither the Company nor any of its Subsidiaries, nor to the Company's knowledge, any of their Representatives acting on their behalf, is party to or subject to any corporate integrity agreement, monitoring agreement, consent decree, deferred prosecution agreement, settlement order or similar Contract with or imposed by any Governmental Entity related to any applicable Healthcare Law that applies to the transactions contemplated by this Agreement or any Ancillary Document.

(d) All Company Products are, as applicable, developed, tested and investigated in compliance in all material respects with applicable Healthcare Laws.

(e) Neither the Company nor any of its Subsidiaries has, nor as it relates to the Company or its Subsidiaries or any Company Product, to the Company's knowledge, has any Person engaged by the Company or any of its Subsidiaries for contract research, consulting or other collaboration services with respect to any Company Product, made any untrue statement of a material fact or a fraudulent statement to the FDA or any other Governmental Entity responsible for enforcement or oversight with respect to applicable Healthcare Laws, or failed to disclose a material fact required to be disclosed to the FDA or such other Governmental Entity that, at the time such disclosure was made, would reasonably be expected to provide a basis for the FDA to invoke its policy respecting "Fraud, Untrue Statements of Material Facts, Bribery, and Illegal Gratuities" set forth in 56 Fed. Reg. 46191 (September 10, 1991), or for any other Governmental Entity to invoke a similar policy.

(f) All preclinical studies conducted or being conducted with respect to all Company Products by or at the direction of the Company or any of its Subsidiaries have been and are being conducted in material compliance with accepted professional scientific standards and all applicable Law, including all applicable Healthcare Laws, including the applicable requirements of Good Laboratory Practices.

(g) None of the Company, its Subsidiaries or any of their directors, officers or employees, and, to the Company's knowledge, none of the Company's or its Subsidiaries' individual independent contractors or other service providers, including clinical trial investigators, coordinators, or monitors, (i) have been or are currently disqualified, excluded or debarred under; (ii) to the Company's knowledge, are currently subject to an investigation or Proceeding that would reasonably be expected to result in disqualification, exclusion or debarment, the assessment of civil monetary penalties for violation of any health care programs of any Governmental Entity under, or (iii) have been convicted of any crime regarding health care products or services, or engaged in any conduct that would reasonably be expected to result in any such debarment, exclusion, disqualification, or ineligibility under applicable Healthcare Laws, including, (A) debarment under 21 U.S.C. Section 335a or any similar Law (B) exclusion under 42 U.S.C. Section 1320a-7 or any similar Law, or (C) exclusion under 48 CFR Subpart Section 9.4, the System for Award Management Nonprocurement Common Rule. None of the Company, its Subsidiaries or any of their current or former directors, officers or employees, and, to the Company's knowledge, none of the Company's or its Subsidiaries' individual independent contractors or other service providers to the extent acting on behalf of the Company or any of its Subsidiaries have been subject to any consent decree of, or criminal or civil fine or penalty imposed by, any Governmental Entity related to fraud, theft, embezzlement, breach of fiduciary responsibility, financial misconduct, or obstruction of an investigation of controlled substances. To the Company's knowledge, none of the Company, its Subsidiaries or any of their current or former directors, officers or employees, individual independent contractors or other service providers to the extent acting on behalf of the Company or any of its Subsidiaries, has been (1) subject to any enforcement, regulatory or administrative proceedings against or affecting the Company or any of its Affiliates relating to material violations of any Healthcare Law and no such enforcement, regulatory or administrative proceeding has been threatened, or (2) a party to any corporate integrity agreement, monitoring agreement, deferred prosecution agreement, consent decree, settlement order or similar agreement imposed by any Governmental Entity. To the Company's knowledge, none of the Company, its Subsidiaries or any of their directors, officers or employees, and, to the Company's knowledge, none of the Company's or its Subsidiaries' individual independent contractors or other service providers to the extent acting on behalf of the Company or any of its Subsidiaries, have received notice from the FDA, any other Governmental Entity or any health insurance institution with respect to debarment, disqualification or restriction.

(h) All material reports, documents, claims, permits and notices required to be filed, maintained or furnished to the FDA or any similar foreign Governmental Entity by the Company or any of its Subsidiaries have been so filed, maintained or furnished, except as would not, individually or in the aggregate, have a Company Material Adverse Effect. To the knowledge of the Company, all such reports, documents, claims, permits and notices were complete and accurate in all material respects on the date filed (or were corrected or supplemented by a subsequent filing).

(i) In the three (3) years prior to the date hereof, neither the Company nor any of its Subsidiaries, nor any of their respective officers, directors or employees, has received written notice from the FDA, the Federal Trade Commission or other Governmental Entity in connection with advertising or promotion of any Company Products, and in respect of the Business, alleging or asserting noncompliance with requirements of any applicable Law.

(j) The Company, its Subsidiaries and, to the Company's knowledge, their Representatives acting for or on their behalf, are and have been for the past three (3) years in compliance with all applicable Healthcare Laws, except as would not have or be reasonably expect to have a Company Material Adverse Effect.

Section 3.25 Investigation; No Other Representations.

(a) The Company, on its own behalf and on behalf of its Representatives, acknowledges, represents, warrants and agrees that (i) it has conducted its own independent review and analysis of, and, based thereon, has formed an independent judgment concerning the business, assets, condition, operations and prospects of the DYNs Parties, and (ii) it has been furnished with or given access to such documents and information about the DYNs Parties and their respective businesses and operations as it and its Representatives have deemed necessary to enable it to make an informed decision with respect to the execution, delivery and performance of this Agreement, the Ancillary Documents and the transactions contemplated hereby and thereby.

(b) In entering into this Agreement and the Ancillary Documents to which it is or will be a party, the Company has relied solely on its own investigation and analysis and the representations and warranties expressly set forth in Article 4 and in the Ancillary Documents to which it is or will be a party and no other representations or warranties of any DYNs Party or any other Person, either express or implied, and the Company, on its own behalf and on behalf of its Representatives, acknowledges, represents, warrants and agrees that, except for the representations and warranties expressly set forth in Article 4 and in the Ancillary Documents to which it is or will be a party, none of the DYNs Parties nor any other Person makes or has made any representation or warranty, either express or implied, in connection with or related to this Agreement, the Ancillary Documents or the transactions contemplated hereby or thereby.

Section 3.26 *PPP Loans*. Neither the Company nor any of its Subsidiaries has applied for or received any loans pursuant to the Paycheck Protection Program established by the CARES Act.

Section 3.27 *EXCLUSIVITY OF REPRESENTATIONS AND WARRANTIES*. NOTWITHSTANDING THE DELIVERY OR DISCLOSURE TO ANY DYNs PARTY OR ANY OF THEIR RESPECTIVE REPRESENTATIVES OF ANY DOCUMENTATION OR OTHER INFORMATION (INCLUDING ANY FINANCIAL PROJECTIONS OR OTHER SUPPLEMENTAL DATA), EXCEPT AS OTHERWISE EXPRESSLY SET FORTH IN THIS ARTICLE 3 OR THE ANCILLARY DOCUMENTS, NEITHER THE COMPANY NOR ANY OTHER PERSON MAKES,

AND THE COMPANY EXPRESSLY DISCLAIMS, ANY REPRESENTATIONS OR WARRANTIES OF ANY KIND OR NATURE, EXPRESS OR IMPLIED, AS TO THE MATERIALS RELATING TO THE BUSINESS AND AFFAIRS OR HOLDINGS OF THE COMPANY AND ITS SUBSIDIARIES THAT HAVE BEEN MADE AVAILABLE TO ANY DYNs PARTY OR ANY OF THEIR REPRESENTATIVES OR IN ANY PRESENTATION OF THE BUSINESS AND AFFAIRS OF THE COMPANY AND ITS SUBSIDIARIES BY OR ON BEHALF OF THE MANAGEMENT OF THE COMPANY OR OTHERS IN CONNECTION WITH THE TRANSACTIONS CONTEMPLATED HEREBY OR BY THE ANCILLARY DOCUMENTS, AND NO STATEMENT CONTAINED IN ANY OF SUCH MATERIALS OR MADE IN ANY SUCH PRESENTATION SHALL BE DEEMED A REPRESENTATION OR WARRANTY HEREUNDER OR OTHERWISE OR DEEMED TO BE RELIED UPON BY ANY DYNs PARTY OR ANY OF THEIR REPRESENTATIVES IN EXECUTING, DELIVERING AND PERFORMING THIS AGREEMENT, THE ANCILLARY DOCUMENTS OR THE TRANSACTIONS CONTEMPLATED HEREBY OR THEREBY. EXCEPT FOR THE REPRESENTATIONS AND WARRANTIES EXPRESSLY SET FORTH IN ARTICLE 4 OR THE ANCILLARY DOCUMENTS, IT IS UNDERSTOOD THAT ANY COST ESTIMATES, PROJECTIONS OR OTHER PREDICTIONS, ANY DATA, ANY FINANCIAL INFORMATION OR ANY MEMORANDA OR OFFERING MATERIALS OR PRESENTATIONS, INCLUDING ANY OFFERING MEMORANDUM OR SIMILAR MATERIALS MADE AVAILABLE BY OR ON BEHALF OF ANY DYNs PARTY ARE NOT AND SHALL NOT BE DEEMED TO BE OR TO INCLUDE REPRESENTATIONS OR WARRANTIES OF ANY DYNs PARTY, AND ARE NOT AND SHALL NOT BE DEEMED TO BE RELIED UPON BY THE COMPANY OR ANY OF ITS REPRESENTATIVES IN EXECUTING, DELIVERING OR PERFORMING THIS AGREEMENT, THE ANCILLARY DOCUMENTS OR THE TRANSACTIONS CONTEMPLATED HEREBY OR THEREBY.

ARTICLE 4
REPRESENTATIONS AND WARRANTIES RELATING TO THE DYNs PARTIES

(a) Subject to Section 8.8, except as set forth on the DYNs Disclosure Schedules or as set forth in any DYNs SEC Reports filed or furnished with the SEC at least one (1) Business Day prior to the date hereof (excluding (i) any disclosures in any “risk factors” section that do not constitute statements of fact, disclosures in any forward-looking statements disclaimers and other disclosures that are generally cautionary, predictive or forward-looking in nature, and (ii) any matters required to be disclosed for purposes of Section 4.1 (*Organization and Qualification*), Section 4.2 (*Authority*), Section 4.4 (*Brokers*), Section 4.6(a) (*Capitalization*) and Section 4.8 (*Trust Account*)), each DYNs Party hereby represents and warrants to the Company, as of the date hereof and as of the Closing Date, as follows:

Section 4.1 *Organization and Qualification*. Each DYNs Party is a corporation, duly organized, incorporated or formed, as applicable, validly existing and in good standing under the Laws of its jurisdiction of incorporation.

Section 4.2 *Authority*. Each DYNS Party has the requisite corporate power and authority to execute and deliver this Agreement and each Ancillary Document to which it is or will be a party, to perform its obligations hereunder and thereunder (subject to the DYNS Stockholder Approval and the stockholder approval contemplated in Section 5.9) and to consummate the transactions contemplated hereby and thereby. Subject to obtaining the DYNS Stockholder Approval and the approvals and consents to be obtained by Merger Sub pursuant to Section 5.9, the execution and delivery of this Agreement, the Ancillary Documents to which a DYNS Party is or will be a party and the consummation of the transactions contemplated hereby and thereby have been (or, in the case of any Ancillary Document entered into after the date of this Agreement, will be upon execution thereof) duly authorized by all necessary corporate action on the part of such DYNS Party. This Agreement and each Ancillary Document to which a DYNS Party is or will be a party has been or will be, upon execution thereof, as applicable, duly and validly executed and delivered by such DYNS Party and constitutes or will constitute, upon execution and delivery thereof, as applicable, a valid, legal and binding agreement of such DYNS Party (assuming that this Agreement and the Ancillary Documents to which such DYNS Party is or will be a party are or will be upon execution thereof, as applicable, duly authorized, executed and delivered by the other Persons party hereto or thereto, as applicable), enforceable against such DYNS Party in accordance with their terms, subject to Enforceability Exceptions.

Section 4.3 Consents and Requisite Governmental Approvals; No Violations.

(a) No consent, approval, waiver or authorization of, or designation, declaration or filing with, any Governmental Entity is required on the part of any DYNS Party with respect to such DYNS Party's execution, delivery or performance of its obligations under this Agreement or the Ancillary Documents to which it is or will be party or the consummation of the transactions contemplated hereby or thereby, except for (i) compliance with and filings under the HSR Act or any filings with or approvals or clearances from any Governmental Entities that the Parties determine (acting reasonably) are required and advisable to consummate the transactions contemplated hereby and thereby, (ii) the filing with the SEC of (A) the Registration Statement/Proxy Statement and the declaration of the effectiveness thereof by the SEC, and (B) such reports under Section 13(a) or 15(d) of the Exchange Act as may be required in connection with this Agreement, the Ancillary Documents or the transactions contemplated hereby or thereby, (iii) such filings with and approvals of Nasdaq to permit Class A Common Stock to be issued in accordance with this Agreement to be listed on Nasdaq, (iv) filing of the Certificate of Merger, (v) the approvals and consents to be obtained by Merger Sub pursuant to Section 5.9, (vi) the DYNS Stockholder Approval, or (vii) any other consents, approvals, authorizations, designations, declarations, waivers or filings, the absence of which would not have a DYNS Material Adverse Effect.

(b) Neither the execution, delivery or performance by any DYNS Party of this Agreement nor the Ancillary Documents to which any DYNS Party is or will be a party, nor the consummation of the transactions contemplated hereby or thereby will, directly or indirectly (with or without due notice or lapse of time or both) (i) result in any breach of any provision of the Governing Documents of any DYNS Party, (ii) result in a violation

or breach of, or constitute a default or give rise to any right of termination, Consent, cancellation, amendment, modification, suspension, revocation or acceleration under, any of the terms, conditions or provisions of any Contract to which any DYNS Party is a party, (iii) violate, or constitute a breach under, any Order or applicable Law to which any such DYNS Party or any of its properties or assets are bound, or (iv) result in the creation of any Lien upon any of the assets or properties (other than any Permitted Liens) or Equity Securities of any DYNS Party, except, in the case of any of clauses (ii) through (iv) above, as would not have a DYNS Material Adverse Effect.

Section 4.4 *Brokers*. Except for fees (including the amounts due and payable assuming the Closing occurs) set forth on Section 4.4 of the DYNS Disclosure Schedules (which fees shall be the sole responsibility of the DYNS, except as otherwise provided in Section 8.6), no broker, finder, investment banker or other Person is entitled to any brokerage fee, finder's fee or other commission in connection with the transactions contemplated by this Agreement based upon arrangements made by or on behalf of DYNS or any of its Affiliates for which DYNS has any obligation.

Section 4.5 *Information Supplied*. None of the information supplied or to be supplied by or on behalf of either DYNS Party expressly for inclusion or incorporation by reference prior to the Closing in the Registration Statement/Proxy Statement will, when the Registration Statement/Proxy Statement is declared effective or when the Registration Statement/Proxy Statement is mailed to the Pre-Closing DYNS Stockholders or at the time of the DYNS Stockholders Meeting, and in the case of any amendment thereto, at the time of such amendment, contain any untrue statement of a material fact or omit to state any material fact required to be stated therein or necessary in order to make the statements therein, in light of the circumstances under which they are made, not misleading.

Section 4.6 Capitalization.

(a) The authorized capital stock of DYNS consists of (i) 100,000,000 shares of Class A Common Stock, (ii) 10,000,000 shares of Class B Common Stock, and (iii) 1,000,000 shares of preferred stock, in each case, par value \$0.0001 per share. As of the date of this Agreement, (A) 23,715,500 shares of Class A Common Stock and 5,750,000 shares of Class B Common Stock are issued and outstanding (which includes 23,000,000 shares subject to Redemption Rights), all of which are validly issued, fully paid and non-assessable, and (B) no shares of DYNS Common Stock are held in the treasury of DYNS.

(b) Except for this Agreement, the Ancillary Documents or the transactions contemplated hereby and thereby, or as mutually agreed to by the Parties, there are no outstanding (i) equity appreciation, phantom equity or profit participation rights, or (ii) options, restricted stock, phantom stock, warrants, purchase rights, subscription rights, conversion rights, exchange rights, calls, puts, rights of first refusal or first offer or other Contracts that would require DYNS, and, except as expressly contemplated by this Agreement, the Ancillary Documents or as mutually agreed in writing by the Parties, there is no obligation of DYNS, to issue, sell or otherwise cause to become outstanding or to acquire, repurchase or redeem any Equity Securities or securities convertible into or exchangeable for Equity Securities of DYNS. There are no voting trusts, proxies or other Contracts with respect to the voting or transfer of DYNS Equity Securities to which DYNS, the Sponsor or, to DYNS's knowledge, any other Person is a party.

(c) The Equity Securities of Merger Sub outstanding as of the date of this Agreement (i) have been duly authorized and validly issued and are fully paid and non-assessable, (ii) were issued in compliance in all material respects with applicable Law, and (iii) were not issued in breach or violation of any preemptive rights or Contract to which DYNs is a party or bound. All of the outstanding Equity Securities of Merger Sub are owned directly by DYNs free and clear of all Liens (other than transfer restrictions under applicable Securities Laws). As of the date of this Agreement, DYNs has no Subsidiaries other than Merger Sub and does not own, directly or indirectly, any Equity Securities in any Person other than Merger Sub.

(d) Section 4.6(d) of the DYNs Disclosure Schedules sets forth a list of all Indebtedness of DYNs as of the date of this Agreement, including the principal amount of such Indebtedness, the outstanding balance as of the date of this Agreement and the debtor and the creditor thereof.

Section 4.7 *SEC Filings*. DYNs has timely filed or furnished all statements, forms, reports and documents required to be filed or furnished by it prior to the date of this Agreement with the SEC pursuant to Federal Securities Laws since its initial public offering (collectively, and together with any exhibits and schedules thereto and other information incorporated therein, and as they have been supplemented, modified or amended since the time of filing, the “**DYNs SEC Reports**”), and will file or furnish all other statements, forms, reports and other documents required to be filed or furnished by it subsequent to the date of this Agreement with the SEC pursuant to Federal Securities Laws (collectively, and together with any exhibits and schedules thereto and other information incorporated therein, and as they may be supplemented, modified or amended after the time of filing, but excluding the Registration Statement/Proxy Statement, the “**Additional DYNs SEC Reports**”). Each of the DYNs SEC Reports, as of their respective dates of filing, and as of the date of any amendment or filing that superseded the initial filing, complied in all material respects, and each of the Additional DYNs SEC Reports, as of their respective dates of filing, and as of the date of any amendment or filing that supersedes the initial filing, will comply in all material respects, with the applicable requirements of the Federal Securities Laws (including, as applicable, the Sarbanes-Oxley Act and any rules and regulations promulgated thereunder) applicable to the DYNs SEC Reports or the Additional DYNs SEC Reports; *provided* that, for purposes of the Additional DYNs SEC Reports, the representation and warranty in this sentence is subject to the representation and warranty set forth in Section 3.23 being true and correct in all respects with respect to all information supplied by or on behalf of the Company expressly for inclusion or incorporation by reference therein. As of their respective dates of filing, the DYNs SEC Reports did not (a) contain any untrue statement of a material fact, or (b) omit to state a material fact required to be stated therein or necessary to make the statements therein, in light of the circumstances under which they were made or will be made, as applicable, not misleading in any material respect. As of the date of this Agreement, there are no outstanding or unresolved comments in comment letters received from the SEC with respect to the DYNs SEC Reports.

Section 4.8 *Trust Account*. As of the date of this Agreement, DYNS has an amount in cash in the Trust Account equal to at least \$230,000,000. The funds held in the Trust Account are (a) invested in United States “government securities” within the meaning of Section 2(a)(16) of the Investment Company Act, having a maturity of 185 days or less or in money market funds meeting certain conditions under Rule 2a-7 promulgated under the Investment Company Act which invest only in direct U.S. government treasury obligations, and (b) held in trust pursuant to that certain Investment Management Trust Agreement, dated May 25, 2021, between DYNS and Continental Stock Transfer & Trust Company, as trustee (the “Trustee”) (the “Trust Agreement”). There are no separate agreements, side letters or other understandings (whether written or unwritten, express or implied) that would cause the description of the Trust Agreement in the DYNS SEC Reports to be inaccurate in any material respect or, to DYNS’s knowledge, that would entitle any Person to any portion of the funds in the Trust Account (other than (i) in respect of deferred underwriting commissions or Taxes, (ii) the Pre-Closing DYNS Stockholders who shall have elected to redeem their Class A Common Stock pursuant to the Governing Documents of DYNS, or (iii) if DYNS fails to complete a business combination within the allotted time period set forth in the Governing Documents of DYNS and liquidates the Trust Account, subject to the terms of the Trust Agreement, DYNS (in limited amounts to permit DYNS to pay the expenses of the Trust Account’s liquidation, dissolution and winding up of DYNS) and then the Pre-Closing DYNS Stockholders). Prior to the Closing, none of the funds held in the Trust Account are permitted to be released, except in the circumstances described in the Governing Documents of DYNS and the Trust Agreement. DYNS has performed all material obligations required to be performed by it to date under, and is not in material default or delinquent in performance or any other respect (claimed or actual) in connection with the Trust Agreement, and, to the knowledge of DYNS, no event has occurred which, with due notice or lapse of time or both, would constitute such a material default thereunder. As of the date of this Agreement, there are no claims or proceedings pending with respect to the Trust Account. Since May 25, 2021, DYNS has not released any money from the Trust Account (other than interest income earned on the funds held in the Trust Account as permitted by the Trust Agreement). Upon the consummation of the transactions contemplated hereby, including the distribution of assets from the Trust Account (A) in respect of deferred underwriting commissions or Taxes, or (B) to the Pre-Closing DYNS Stockholders who have elected to redeem their Class A Common Stock pursuant to the Governing Documents of DYNS, each in accordance with the terms of and as set forth in the Trust Agreement, DYNS shall have no further obligation under either the Trust Agreement or the Governing Documents of DYNS to liquidate or distribute any assets held in the Trust Account, and the Trust Agreement shall terminate in accordance with its terms.

Section 4.9 *Transactions with Affiliates*. Section 4.9 of the DYNS Disclosure Schedules sets forth all Contracts between (a) DYNS, on the one hand, and (b) any officer, director, employee, partner, member, manager, direct or indirect equityholder (including the Sponsor) or Affiliate of either DYNS or the Sponsor or any family member

of the forgoing Persons, on the other hand (each Person identified in this clause (b), a “**DYNS Related Party**”), other than (i) Contracts with respect to a DYNS Related Party’s employment with, or the provision of services to, DYNS entered into in the ordinary course of business (including benefit plans, indemnification arrangements and other ordinary course compensation), and (ii) Contracts entered into after the date of this Agreement that are either permitted pursuant to Section 5.10 or entered into in accordance with Section 5.10. No DYNS Related Party (A) owns any interest in any material asset used in the business of DYNS, (B) possesses, directly or indirectly, any material financial interest in, or is a director or executive officer of, any Person which is a material client, supplier, lender, partner, customer, lessor, lessee or other material business relation of DYNS or (C) owes any material amount to, or is owed any material amount by, DYNS. All Contracts, arrangements, understandings, interests and other matters that are required to be disclosed pursuant to this Section 4.9 are referred to herein as “**DYNS Related Party Transactions.**”

Section 4.10 *Litigation*. There is (and since its organization, incorporation or formation, as applicable, there has been) no Proceeding pending or, to DYNS’s knowledge, threatened against any DYNS Party that, if adversely decided or resolved, would be material to the DYNS Parties, taken as a whole. None of the DYNS Parties nor any of their respective properties or assets is subject to any material Order. As of the date of this Agreement, there are no material Proceedings by any DYNS Party pending against any other Person.

Section 4.11 *Compliance with Applicable Law*. Each DYNS Party is (and since its incorporation has been) in compliance with all applicable Laws, except as would not be material to the DYNS Parties, taken as a whole.

Section 4.12 *Merger Sub Activities*. Merger Sub was organized solely for the purpose of entering into this Agreement, the Ancillary Documents and consummating the transactions contemplated hereby and thereby and has not engaged in any activities or business, other than those incident or related to or incurred in connection with its incorporation or the negotiation, preparation or execution of this Agreement or any Ancillary Documents, the performance of its covenants or agreements in this Agreement or any Ancillary Document or the consummation of the transactions contemplated hereby or thereby. Merger Sub does not have any Indebtedness.

Section 4.13 *Internal Controls; Listing; Financial Statements*.

(a) Except as not required in reliance on exemptions from various reporting requirements by virtue of DYNS’s status as an “emerging growth company” within the meaning of the Securities Act, as modified by the Jumpstart Our Business Startups Act of 2012, as amended, or “smaller reporting company” within the meaning of the Exchange Act, since its initial public offering, (i) DYNS has established and maintained a system of internal controls over financial reporting (as defined in Rule 13a-15 and Rule 15d-15 under the Exchange Act) sufficient to provide reasonable assurance regarding the reliability of DYNS’s financial reporting and the preparation of DYNS’s financial statements for external purposes in accordance with GAAP, and (ii) DYNS has

established and maintained disclosure controls and procedures (as defined in Rule 13a-15 and Rule 15d-15 under the Exchange Act) designed to ensure that information relating to DYNS is made known to DYNS's principal executive officer and principal financial officer by others within DYNS. Such disclosure controls and procedures are effective in timely alerting DYNS's principal executive officer and principal financial officer to material information required to be included in DYNS's periodic reports required under the Exchange Act.

(b) Each director and executive officer of DYNS has filed with the SEC on a timely basis all statements required by Section 16(a) of the Exchange Act and the rules and regulations promulgated thereunder. DYNS has not taken any action prohibited by Section 402 of the Sarbanes-Oxley Act.

(c) Since its initial public offering, DYNS has complied in all material respects with all applicable listing and corporate governance rules and regulations of Nasdaq. The class of securities representing issued and outstanding Class A Common Stock are registered pursuant to Section 12(b) of the Exchange Act and are listed for trading on Nasdaq. There is no Proceeding pending or, to the knowledge of DYNS, threatened against DYNS by Nasdaq or the SEC with respect to any intention by such entity to deregister the Class A Common Stock or prohibit or terminate the listing of Class A Common Stock on Nasdaq. DYNS has not taken any action that is designed to terminate the registration of Class A Common Stock under the Exchange Act.

(d) (i) The DYNS SEC Reports contain true and complete copies of the financial statements (including all related notes and schedules thereto) of DYNS (the "**DYNS Financial Statements**"). The DYNS Financial Statements (A) fairly present in all material respects the financial position of DYNS as at the respective dates thereof, and the results of its operations and cash flows for the respective periods then ended and fairly present, in all material respects, its stockholders' equity, (B) were prepared in conformity with GAAP applied on a consistent basis during the periods involved, and (C) comply, in all material respects, with the applicable accounting requirements and with the rules and regulations of the SEC, the Exchange Act and the Securities Act in effect as of the respective dates thereof (including Regulation S-X or Regulation S-K, as applicable).

(e) DYNS has established and maintains systems of internal accounting controls that are designed to provide, in all material respects, reasonable assurance that (i) all transactions are executed in accordance with management's authorization, and (ii) all transactions are recorded as necessary to permit preparation of proper and accurate financial statements in accordance with GAAP and to maintain accountability for DYNS's and its Subsidiaries' assets. DYNS maintains and, for all periods covered by the DYNS Financial Statements, has maintained, in all material respects in accordance with GAAP and applicable Law, books and records of DYNS in the ordinary course of business that are accurate and complete and reflect the revenues, expenses, assets and Liabilities of DYNS.

(f) There are no outstanding loans or other extensions of credit made by DYNS to any executive officer (as defined in Rule 3b-7 under the Exchange Act) or director of DYNS.

(g) Except as set forth on Section 4.13(g) of the DYNS Disclosure Schedules, since its incorporation, neither DYNS (including any employee thereof) nor, to the knowledge of DYNS, DYNS's independent auditors, has received any written complaint, allegation, assertion or claim that there is, or there has been, (i) a "significant deficiency" in the internal controls over financial reporting of DYNS, (ii) a "material weakness" in the internal controls over financial reporting of DYNS, or (iii) fraud, whether or not material, that involves management or other employees of DYNS who have a role in the internal controls over financial reporting of DYNS.

Section 4.14 *No Undisclosed Liabilities*. Except for the Liabilities (a) set forth in Section 4.14 of the DYNS Disclosure Schedules, (b) incurred in connection with the negotiation, preparation or execution of this Agreement or any Ancillary Documents, the performance of its covenants or agreements in this Agreement or any Ancillary Document or the consummation of the transactions contemplated hereby or thereby (including, for the avoidance of doubt, the DYNS Expenses and any Liabilities arising out of, or related to, any Proceeding related to this Agreement, the Ancillary Documents or the transactions contemplated hereby or thereby, including any stockholder demand or other stockholder Proceedings (including derivative claims) arising out of, or related to, any of the foregoing), (c) set forth or disclosed in the DYNS Financial Statements, (d) that have arisen since the date of the most recent balance sheet included in the DYNS SEC Reports in the ordinary course of business, (e) either permitted to be incurred pursuant to or incurred in accordance with Section 5.10, or (f) that are not, and would not reasonably be expected to be, individually or in the aggregate, material to DYNS, DYNS does not have any Liabilities.

Section 4.15 *Employee Matters*. DYNS does not have any current or former employees, and does not maintain, sponsor, contribute to or have any present or future Liability with respect to (other than as a result of the transactions contemplated by this Agreement) any "employee benefit plan" (as such term is defined in Section 3(3) of ERISA).

Section 4.16 *Tax Matters*.

(a) Each DYNS Party has prepared and filed all material Tax Returns required to have been filed by it, all such Tax Returns are true and complete in all material respects and prepared in compliance in all material respects with all applicable Laws and Orders, and each DYNS Party has paid all material Taxes required to have been paid or deposited by it regardless of whether shown on a Tax Return.

(b) Each DYNS Party has timely withheld and paid to the appropriate Tax Authority all material amounts required to have been withheld and paid in connection with amounts paid or owing to any employee, individual independent contractor, other service providers, equity interest holder or other third-party.

(c) No DYNS Party is currently the subject of a Tax audit or examination, and has not been informed in writing of the commencement or anticipated commencement of any Tax audit or examination that has not been resolved or completed, in each case with respect to material Taxes.

(d) No DYNS Party has consented to extend or waive the time in which any material Tax may be assessed or collected by any Tax Authority, other than any such extensions or waivers that are no longer in effect or that were extensions of time to file Tax Returns obtained in the ordinary course of business.

(e) No "closing agreement" as described in Section 7121 of the Code (or any corresponding or similar provision of state, local or non-U.S. income Tax Law), private letter rulings, technical advice memoranda or similar agreements or rulings have been entered into or issued by any Tax Authority with respect to any DYNS Party which agreement or ruling would be effective after the Closing Date.

(f) None of the DYNS Parties is and none of the DYNS Parties has been a party to any "listed transaction" as defined in Section 6707A of the Code and Treasury Regulations Section 1.6011-4 (or any corresponding or similar provision of state, local or non-U.S. income Tax Law).

(g) There are no Liens for Taxes on any assets of any DYNS Party other than Liens for Taxes not yet delinquent as of the Closing Date or which are being contested in good faith by appropriate proceedings and for which sufficient reserves have been established in accordance with GAAP.

(h) No DYNS Party has been a distributing corporation or a controlled corporation in a transaction purported or intended to be governed by Section 355 of the Code.

(i) No DYNS Party (i) has been a member of an affiliated group filing a consolidated federal income Tax Return (other than a group the common parent of which was DYNS) or (ii) has any material Liability for the Taxes of any Person (other than the DYNS Parties) under Section 1.1502-6 of the Treasury Regulations (or any similar provision of state, local or non-U.S. Law), as a transferee or successor, by Contract or otherwise (other than any Contract entered into in the ordinary course of business the principal purpose of which does not relate to Taxes).

(j) No written claims have ever been made by any Tax Authority in a jurisdiction where a DYNS Party does not file a particular type of Tax Return or pay a particular type of Tax that such DYNS Party is or may be required to file such type of Tax Return in or pay such type of Tax to that jurisdiction, which claims have not been resolved or withdrawn.

(k) No DYNS Party is a party to any Tax allocation, Tax sharing or Tax indemnity or similar agreements (other than one that is included in a Contract entered into in the ordinary course of business that is not primarily related to Taxes) and no DYNS Party is a party to any joint venture, partnership or other arrangement that is treated as a partnership for U.S. federal income Tax purposes.

(l) Each DYNS Party is tax resident only in its jurisdiction of organization, incorporation or formation, as applicable.

(m) No DYNS Party has a branch, permanent establishment (within the meaning of an applicable Tax treaty) or otherwise has an office or fixed place of business in a country other than the country in which it is organized.

(n) No DYNS Party will be required to include any item of income in, or exclude any item of deduction from, taxable income for any taxable period (or portion thereof) ending after the Closing Date as a result of any (i) change in, or use of improper, method of accounting for a taxable period ending on or prior to the Closing Date, (ii) "closing agreement" as described in Section 7121 of the Code (or any corresponding or similar provision of state, local or foreign income Tax Law) executed on or prior to the Closing Date, (iii) installment sale or open transaction disposition made on or prior to the Closing Date, (iv) prepaid amount received on or prior to the Closing Date, outside of the ordinary course of Business (v) intercompany transaction or excess loss amount described in Treasury Regulations under Section 1502 of the Code (or any corresponding or similar provision of state, local or foreign income Tax Law), or (vi) election under Section 965(h) of the Code.

(o) No DYNS Party has deferred any Taxes under Section 2302 of the CARES Act.

(p) All related party transactions involving the DYNS Parties are at arm's length in compliance with Section 482 of the Code, the Treasury Regulations promulgated thereunder and any similar provision of state, local or non-U.S. Law.

(q) None of the DYNS Parties (i) knows of any fact or circumstance, or (ii) has taken or agreed to take any action not contemplated by this Agreement or any Ancillary Documents, in each case, that would reasonably be expected to prevent the Merger from qualifying for the Intended Tax Treatment.

Section 4.17 Investigation; No Other Representations.

(a) Each DYNS Party, on its own behalf and on behalf of its Representatives, acknowledges, represents, warrants and agrees that (i) it has conducted its own independent review and analysis of, and, based thereon, has formed an independent judgment concerning the business, assets, condition, operations and prospects of, the Company and its Subsidiaries, and (ii) it has been furnished with or given access to such documents and information about the Company, its Subsidiaries and the Business as it and its Representatives have deemed necessary to enable it to make an informed decision with respect to the execution, delivery and performance of this Agreement, the Ancillary Documents to which it is or will be a party and the transactions contemplated hereby and thereby.

(b) In entering into this Agreement and the Ancillary Documents to which it is or will be a party, each DYNs Party has relied solely on its own investigation and analysis and the representations and warranties expressly set forth in Article 3 and in the Ancillary Documents to which it is or will be a party and no other representations or warranties of the Company or any other Person, either express or implied, and each DYNs Party, on its own behalf and on behalf of its Representatives, acknowledges, represents, warrants and agrees that, except for the representations and warranties expressly set forth in Article 3 and in the Ancillary Documents to which it is or will be a party, neither the Company nor any other Person makes or has made any representation or warranty, either express or implied, in connection with or related to this Agreement, the Ancillary Documents or the transactions contemplated hereby or thereby.

Section 4.18 *EXCLUSIVITY OF REPRESENTATIONS AND WARRANTIES*. NOTWITHSTANDING THE DELIVERY OR DISCLOSURE TO THE COMPANY OR ANY OF ITS REPRESENTATIVES OF ANY DOCUMENTATION OR OTHER INFORMATION (INCLUDING ANY FINANCIAL PROJECTIONS OR OTHER SUPPLEMENTAL DATA), EXCEPT AS OTHERWISE EXPRESSLY SET FORTH IN THIS ARTICLE 4 OR THE ANCILLARY DOCUMENTS, NONE OF THE DYNs PARTIES NOR ANY OTHER PERSON MAKES, AND EACH DYNs PARTY EXPRESSLY DISCLAIMS, ANY REPRESENTATIONS OR WARRANTIES OF ANY KIND OR NATURE, EXPRESS OR IMPLIED, AS TO THE MATERIALS RELATING TO THE BUSINESS AND AFFAIRS OR HOLDINGS OF ANY DYNs PARTY THAT HAVE BEEN MADE AVAILABLE TO THE COMPANY OR ANY OF ITS REPRESENTATIVES OR IN ANY PRESENTATION OF THE BUSINESS AND AFFAIRS OF ANY DYNs PARTY BY OR ON BEHALF OF THE MANAGEMENT OF SUCH DYNs PARTY OR OTHERS IN CONNECTION WITH THE TRANSACTIONS CONTEMPLATED HEREBY OR BY THE ANCILLARY DOCUMENTS, AND NO STATEMENT CONTAINED IN ANY OF SUCH MATERIALS OR MADE IN ANY SUCH PRESENTATION SHALL BE DEEMED A REPRESENTATION OR WARRANTY HEREUNDER OR OTHERWISE OR DEEMED TO BE RELIED UPON BY THE COMPANY OR ANY OF ITS REPRESENTATIVES IN EXECUTING, DELIVERING AND PERFORMING THIS AGREEMENT, THE ANCILLARY DOCUMENTS OR THE TRANSACTIONS CONTEMPLATED HEREBY OR THEREBY. EXCEPT FOR THE REPRESENTATIONS AND WARRANTIES EXPRESSLY SET FORTH IN ARTICLE 3 OR THE ANCILLARY DOCUMENTS, IT IS UNDERSTOOD THAT ANY COST ESTIMATES, PROJECTIONS OR OTHER PREDICTIONS, ANY DATA, ANY FINANCIAL INFORMATION OR ANY MEMORANDA OR OFFERING MATERIALS OR PRESENTATIONS, INCLUDING ANY OFFERING MEMORANDUM OR SIMILAR MATERIALS MADE AVAILABLE BY OR ON BEHALF OF THE COMPANY, ARE NOT AND SHALL NOT BE DEEMED TO BE OR TO INCLUDE REPRESENTATIONS OR WARRANTIES OF THE COMPANY, AND ARE NOT AND SHALL NOT BE DEEMED TO BE RELIED UPON BY ANY DYNs PARTY OR ANY OF ITS REPRESENTATIVES IN EXECUTING, DELIVERING OR PERFORMING THIS AGREEMENT, THE ANCILLARY DOCUMENTS OR THE TRANSACTIONS CONTEMPLATED HEREBY OR THEREBY.

ARTICLE 5
COVENANTS

Section 5.1 Conduct of Business of the Company.

(a) From and after the date of this Agreement until the earlier of the Closing or the termination of this Agreement in accordance with its terms (the “**Interim Period**”), the Company shall, and shall cause its Subsidiaries to, except as expressly contemplated by this Agreement or any Ancillary Document, as required by applicable Law, as set forth on Section 5.1(a) of the Company Disclosure Schedules, to reasonably comply with any applicable Pandemic Measures or as expressly consented to in writing by DYNS (it being agreed that any request for a consent shall not be unreasonably withheld, conditioned or delayed), (i) operate the Business in the ordinary course and, where applicable, consistent with past practice, in all material respects, and (ii) use commercially reasonable efforts to maintain and preserve intact the business organization, assets, properties and material business relations of the Company and its Subsidiaries; *provided* that in no event shall the Company’s and its Subsidiaries’ compliance with Section 5.1(b) constitute a breach of this Section 5.1(a); *and provided further*, that any action taken, or omitted to be taken, by the Company or any of its Subsidiaries, or by the Company Board or the board of directors of any Subsidiary, to the extent such act or omission is reasonably determined by the Company, its Subsidiary the Company Board or the board of directors of the relevant Subsidiary to be reasonably necessary or advisable to comply with any Pandemic Measures, shall in no event be deemed to constitute a breach of Section 5.1 (provided, however, (1) that the Company shall give DYNS prior written notice of any such act or omission to the extent reasonably practicable and, in the event that it is not reasonably practicable for the Company to give the prior written notice described in this clause (1), the Company shall instead give such written notice to DYNS promptly after such act or omission, and (2) in no event shall any act or omission be deemed in accordance with this sentence to not constitute a breach of Section 5.1 if the act or omission is of the type described in Section 5.1(b) (i), (ii), (iv), (v), (vii), (ix), (x) (solely relating to the Company’s directors and officers), (xii), (xiv), (xv), (xviii) and (xxi).

(b) Without limiting the generality of the foregoing, during the Interim Period, the Company shall, except as expressly contemplated by this Agreement or any Ancillary Document, as required by applicable Law, as set forth on Section 5.1(b) of the Company Disclosure Schedules or as expressly consented to in writing by DYNS (such consent, other than in the case of Section 5.1(b)(i) or Section 5.1(b)(xxi), or Section 5.1(b)(xxii) to the extent that it relates to those Sections, not to be unreasonably withheld, conditioned or delayed), not do, and shall cause its Subsidiaries not to do, any of the following:

(i) declare, set a record date for, set aside, make or pay a dividend on, or make any other distribution or payment in respect of, any of its issued and outstanding Equity Securities, or repurchase, cancel, redeem, facilitate a capital reduction in respect of or otherwise acquire any of its issued and outstanding Equity Securities or any securities convertible into (whether currently convertible or convertible only after the passage of time or the occurrence of certain events) or exchangeable for its Equity Securities, or offer to do any of these things;

(ii) (A) merge, consolidate, combine or amalgamate with any Person, or (B) purchase or otherwise acquire (whether by merging or consolidating with, purchasing any Equity Securities in or a substantial portion of the assets of, or by any other manner) any corporation, partnership, limited liability company, joint venture, association or other business entity or organization or division thereof;

(iii) adjust, split, combine, subdivide, recapitalize, reclassify or otherwise effect any change in respect of any of its Equity Securities or issue any other security in respect of, in lieu of or in substitution for its Equity Securities;

(iv) adopt or propose that its stockholders approve or adopt any amendments, supplements, restatements or modifications to its Governing Documents;

(v) (A) sell, assign, transfer, convey, abandon, lease, license, allow to lapse or expire or otherwise dispose of any material assets or properties (including the Leased Real Property but excluding Intellectual Property Rights), other than obsolete assets or properties or in the ordinary course of business, or (B) create, subject to or incur any Lien (other than a Permitted Lien) in respect of any material assets or properties (including the Leased Real Property but excluding Intellectual Property Rights);

(vi) other than grants to current and new employees, officers and directors pursuant to the Company Equity Plan in the ordinary course and consistent with past practice, transfer, issue, deliver, sell, pledge, grant or otherwise directly or indirectly dispose of, or subject to a Lien, (A) any of its Equity Securities or the Equity Securities of any Subsidiary, as applicable, or (B) any options, warrants, rights of conversion or other rights, agreements, arrangements or commitments obligating it to transfer, issue, deliver, sell, pledge, grant or otherwise directly or indirectly dispose of, or subject to a Lien, any of its Equity Securities or the Equity Securities of any Subsidiary, as applicable;

(vii) incur, create, assume or otherwise become liable for (whether directly, contingently or otherwise), or guarantee for the benefit of another Person, any Indebtedness in excess of \$500,000 (other than equipment financing and trade payables incurred in the ordinary course of Business), individually or in the aggregate;

(viii) enter into, amend, modify, waive any material benefit or right under, novate, assign, assume or terminate or rescind any Material Contract (excluding, for the avoidance of doubt, any expiration or automatic extension or renewal of any such Material Contract pursuant to its terms, or entering into additional work orders pursuant to, and in accordance with the terms of, any Material Contract);

(ix) make any loans, advances or capital contributions of money or other property to, or guarantees for the benefit of, or any investments in, any Person in excess of \$250,000, individually or in the aggregate, other than (A) the reimbursement of expenses of employees in the ordinary course of business, and (B) prepayments and deposits paid to suppliers of the Company and its Subsidiaries in the ordinary course of business;

(x) except as required under the terms of any Employee Benefit Plan, (A) amend or modify in any material respect, adopt, enter into, materially alter the prior interpretation of, waive any material benefit or right under or terminate or rescind any Employee Benefit Plan or any benefit or compensation plan, policy, program or Contract that would be an Employee Benefit Plan if in effect as of the date of this Agreement, (B) increase or agree to increase the compensation, bonus or other benefits payable, or pay or agree to pay any bonus to, any current or former Key Employee or Contingent Worker, other than, in each case, individual annual and merit-based raises of up to three percent (3%) in the salary or wages of any such Key Employee or Contingent Worker and bonus payments made in the ordinary course of business and consistent with past practice, as applicable, (C) take any action to accelerate any payment, right to payment or benefit, or the vesting or funding of any payment, right to payment or benefit, payable or to become payable to any current or former Key Employee or Contingent Worker, (D) waive or release any noncompetition, non-solicitation, no-hire, nondisclosure or other restrictive covenant obligation of any current or former Key Employee, (E) pay or agree to pay any severance or change in control pay or benefits, or otherwise increase the severance or change in control pay or benefits of, any current or former executive director, manager, officer or employee, or (F) hire or terminate (other than for cause) or furlough the employment of any Key Employee (or person who would be a Key Employee, were they hired by the Company or any of its Subsidiaries), or terminate any group of employees if such group termination would trigger the WARN Act;

(xi) enter into, assume, assign, amend any material term of or terminate (excluding any expiration in accordance with its terms) any collective bargaining or similar agreement (including agreements with works councils and trade unions and side letters) to which it is a party or by which it is bound, other than in the ordinary course of business consistent with past practice;

(xii) make, change or revoke any material Tax election or material Tax accounting method, file any material Tax Return in a manner inconsistent with past practice, amend any material Tax Return, enter into any agreement with a Governmental Entity with respect to a material amount of Taxes, settle or compromise any claim or assessment by a Governmental Entity in respect of any material amount of Taxes, surrender any right to claim a refund of a material amount of Taxes, consent to any extension or waiver of the statutory period of limitation applicable to any material Tax claim or assessment or enter into any Tax sharing or similar agreement (other than any agreement entered into in the ordinary course of business, the primary purpose of which does not relate to Taxes);

(xiii) waive, release, compromise, settle or satisfy any pending or threatened claim or compromise or settle any Liability, whether by Contract or otherwise, the performance of which would, at any time (A) involve the payment of more than \$250,000 in the aggregate, (B) impose any material, non-monetary obligations on it (or DYNS or any of its Affiliates after the Closing), (C) require it to accept or concede material injunctive relief or (D) involve a Governmental Entity or alleged criminal wrongdoing;

(xiv) authorize, recommend, propose or announce an intention to adopt, or otherwise effect, a plan of complete or partial liquidation, dissolution, restructuring, recapitalization, reorganization or similar transaction;

(xv) change the Company's accounting principles, policies, procedures, practices or methods in any material respect, or make any change which would materially affect the reported consolidated assets, liabilities or results of operations of the Company and its Subsidiaries, other than changes that are made in accordance with GAAP or PCAOB standards;

(xvi) enter into any Contract with any broker, finder, investment banker or other Person under which such Person is or will be entitled to any brokerage fee, finder's fee or other commission in connection with the transactions contemplated by this Agreement;

(xvii) enter into any Contract or other arrangement that materially restricts its or its Affiliates' ability to engage or compete in any material line of business or enter into a new material line of business;

(xviii) make any capital expenditure that in the aggregate exceeds \$1,000,000, other than any capital expenditure (or series of related capital expenditures) consistent with the capital expenditures budget set forth in Section 5.1(b)(xviii) of the Company Disclosure Schedules;

(xix) voluntarily fail to maintain in full force and effect material insurance policies covering it and its Affiliates and their respective properties, assets and businesses in a form and amount consistent with past practice;

(xx) enter into any transaction or amend in any material respect any existing Contract with any Company Related Party excluding, to the extent permitted under Section 5.1(b)(x), ordinary course payments of annual compensation, provision of benefits or reimbursement of expenses;

(xxi) make any Change of Control Payment that is not set forth on Section 3.2(d) of the Company Disclosure Schedules;

(xxii) sell, assign, transfer, convey, abandon, lease, license, allow to lapse or expire, or otherwise dispose of, fail to take any action necessary to maintain, enforce or protect, or create or incur any Lien (other than Permitted Liens) on, any Intellectual Property Rights, except granting non-exclusive licenses pursuant to clinical trial agreements or supply agreements in which clinical trials or supply services are being performed for the Company or any of its Subsidiaries, in each case, that are entered into by the Company or any of its Subsidiaries in the ordinary course of business and where the grant of rights to use any Intellectual Property Rights are incidental, and not material to, any performance under each such agreement; or

(xxiii) enter into any Contract to take or cause to be taken, or otherwise become obligated to take or cause to be taken, any of the actions set forth in this Section 5.1.

Notwithstanding anything in this Section 5.1 or this Agreement to the contrary, nothing set forth in this Agreement shall give DYNs, directly or indirectly, the right to control or direct the operations of the Company prior to the Closing.

Section 5.2 Efforts to Consummate.

(a) Subject to the terms and conditions herein provided, each of the Parties shall use reasonable best efforts to take, or cause to be taken, all actions and to do, or cause to be done, all things reasonably necessary or advisable to consummate and make effective, as promptly as reasonably practicable, the transactions contemplated by this Agreement (including (i) the satisfaction, but not waiver, of the Closing conditions set forth in Article 6 and, in the case of any Ancillary Document to which such Party will be a party after the date of this Agreement, to execute and deliver such Ancillary Document when required pursuant to this Agreement, (ii) using reasonable best efforts to solicit proxies in connection with the DYNs Stockholder Approval, and (iii) using reasonable best efforts to obtain the PIPE Financing on the terms and subject to the conditions set forth in the Subscription Agreements, and (iv) the Company taking, or causing to be taken, all actions necessary or advisable to cause the agreements set forth on Section 5.2(a) of the Company Disclosure Schedules to be terminated effective as of the Closing without any further obligations or liabilities to the Company or any of its Affiliates (including, from and after the Effective Time, DYNs)). Without limiting the generality of the foregoing, each of the Parties shall use reasonable best efforts to obtain, file with or deliver to, as applicable, any Consents of any Governmental Entities necessary, proper or advisable to consummate the transactions contemplated by this Agreement or the Ancillary Documents. The costs incurred in connection with obtaining such Consents, including the HSR Act filing fee, shall be borne 50% by the Company and 50% by DYNs; *provided, however*, that each Party shall bear its out-of-pocket costs and expenses in connection with the preparation of any such Consents. Each Party shall (A) make any appropriate filings pursuant to the HSR Act with respect to the transactions contemplated by this Agreement promptly (and in any event within ten (10) Business Days) following the date of this Agreement, and (B) respond as promptly as reasonably practicable to any requests by any Governmental Entity for additional information and documentary

material that may be requested pursuant to the HSR Act. DYNS shall promptly inform the Company of any communication between any DYNS Party, on the one hand, and any Governmental Entity, on the other hand, and the Company shall promptly inform DYNS of any communication between the Company or any of its Affiliates, on the one hand, and any Governmental Entity, on the other hand, in either case, regarding any of the transactions contemplated by this Agreement or any Ancillary Document. Without limiting the foregoing, each Party and their respective Affiliates shall not extend any waiting period, review period or comparable period under the HSR Act or enter into any agreement with any Governmental Entity not to consummate the transactions contemplated hereby or by the Ancillary Documents, except with the prior written consent of DYNS and the Company. Nothing in this Section 5.2 obligates any Party or any of its Affiliates to agree to (1) sell, license or otherwise dispose of, or hold separate and agree to sell, license or otherwise dispose of, any entities, assets or facilities, (2) terminate, amend or assign existing relationships and contractual rights or obligations, including licenses, or (3) enter into new licenses or other agreements. No Party shall agree to any of the foregoing measures with respect to any other Party, except with DYNS's and the Company's prior written consent.

(b) During the Interim Period, and unless prohibited by applicable Law, the DYNS Parties, on the one hand, and the Company, on the other hand, shall give counsel for the Company (in the case of any DYNS Party) or DYNS (in the case of the Company) a reasonable opportunity to review in advance, and consider in good faith the views of the other in connection with, any proposed written communication to any Governmental Entity relating to the transactions contemplated by this Agreement or the Ancillary Documents. Each of the Parties agrees not to participate in any substantive meeting or discussion, either in person or by telephone, with any Governmental Entity in connection with the transactions contemplated by this Agreement unless it consults with, in the case of any DYNS Party, the Company, or, in the case of the Company, DYNS in advance.

(c) Notwithstanding anything to the contrary in the Agreement, in the event that this Section 5.2 conflicts with any other covenant or agreement in this Article 5 that is intended to specifically address certain subject matter, then such other covenant or agreement shall govern and control solely to the extent of such conflict.

Section 5.3 Confidentiality and Access to Information.

(a) The Parties hereby acknowledge and agree that the information being provided in connection with this Agreement and the consummation of the transactions contemplated hereby is subject to the terms of the Confidentiality Agreement, the terms of which are incorporated herein by reference, *mutatis mutandis*. Notwithstanding the foregoing or anything to the contrary in this Agreement, in the event that this Section 5.3(a) or the Confidentiality Agreement conflicts with any other covenant or agreement contained herein that contemplates the disclosure, use or provision of information or otherwise, then such other covenant or agreement contained herein shall govern and control to the extent of such conflict.

(b) During the Interim Period, upon reasonable advance written notice, the Company shall provide, or cause to be provided, to DYNs and its Representatives during normal business hours reasonable access to the directors, officers, books and records of the Company (in a manner so as to not interfere with the normal business operations of the Company or, in light of COVID-19 or any Pandemic Measures, jeopardize the health or safety of any employee of the Company (which may require remote and telephonic meetings)). Notwithstanding the foregoing, the Company shall not be required to provide, or cause to be provided, to DYNs or any of its Representatives any information (i) if, and to the extent, doing so would (A) violate any Law to which the Company is subject, (B) result in the disclosure of any trade secrets, (C) violate any legally-binding obligation of the Company with respect to confidentiality, non-disclosure or privacy or (D) jeopardize protections afforded to the Company under the attorney-client privilege or the attorney work product doctrine (*provided* that, in case of each of clauses (A) through (D), the Company shall use commercially reasonable efforts to (x) provide such access as can be provided (or otherwise convey such information regarding the applicable matter as can be conveyed) without violating such privilege, doctrine, Contract, obligation or Law, and (y) provide such information in a manner without violating such privilege, doctrine, Contract, obligation or Law), or (ii) if the Company, on the one hand, and any DYNs Party or any of its Representatives, on the other hand, are adverse parties in a litigation and such information is reasonably pertinent thereto; *provided* that the Company shall, in the case of clause (i) or (ii), provide prompt written notice of the withholding of access or information on any such basis.

(c) During the Interim Period, upon reasonable advance written notice, DYNs shall provide, or cause to be provided, to the Company and its Representatives during normal business hours reasonable access to the directors, officers, books and records of the DYNs Parties (in a manner so as to not interfere with the normal business operations of the DYNs Parties or, in light of COVID-19 or any Pandemic Measures, jeopardize the health or safety of any employee of the DYNs Parties (which may require remote and telephonic meetings)). Notwithstanding the foregoing, DYNs shall not be required to provide, or cause to be provided, to the Company or any of its Representatives any information (i) if and to the extent doing so would (A) violate any Law to which any DYNs Party is subject, (B) result in the disclosure of any trade secrets, (C) violate any legally-binding obligation of any DYNs Party with respect to confidentiality, non-disclosure or privacy or (D) jeopardize protections afforded to any DYNs Party under the attorney-client privilege or the attorney work product doctrine (*provided* that, in case of each of clauses (A) through (D), DYNs shall use, and shall cause the other DYNs Parties to use, commercially reasonable efforts to (x) provide such access as can be provided (or otherwise convey such information regarding the applicable matter as can be conveyed) without violating such privilege, doctrine, Contract, obligation or Law, and (y) provide such information in a manner without violating such privilege, doctrine, Contract, obligation or Law), or (ii) if a DYNs Party, on the one hand, and the Company or any of its Representatives, on the other hand, are adverse parties in a litigation and such information is reasonably pertinent thereto; *provided* that DYNs shall, in the case of clause (i) or (ii), provide prompt written notice of the withholding of access or information on any such basis.

(d) The Parties hereby acknowledge and agree that the Confidentiality Agreement shall be automatically terminated effective as of the Closing without any further action by any Party or any other Person.

Section 5.4 Public Announcements.

(a) Subject to Section 5.4(a), Section 5.7 and Section 5.8, none of the Parties or any of their respective Representatives or Affiliates shall issue any press releases or make any public announcements with respect to this Agreement or the transactions contemplated hereby without the prior written consent of, prior to the Closing, the Company and DYNS or, after the Closing, DYNS; *provided, however*, that each Party may make any such announcement or other communication (i) if such announcement or other communication is required by applicable Law, in which case (A) prior to the Closing, the disclosing Party and its Representatives shall, where permitted under applicable Law and feasible with regard to any time limits imposed thereby in relation to making such announcement or other communication, use reasonable best efforts to consult with the Company, if the disclosing party is any DYNS Party, or with DYNS, if the disclosing party is the Company, prior to making such announcement or other communication, to review such announcement or communication and to give such non-disclosing party the opportunity to comment thereon, in which case the disclosing Party shall consider such comments in good faith, or (B) after the Closing, the disclosing Party and its Representatives shall, where permitted under applicable Law and feasible with regard to any time limits imposed thereby in relation to making such announcement or other communication, use reasonable best efforts to consult with DYNS prior to making such announcement or other communication and to consider any comments of DYNS thereon in good faith, (ii) to the extent such announcements or other communications contain only information previously disclosed in a public statement, press release or other communication previously approved in accordance with this Section 5.4, and (iii) to Governmental Entities in connection with any Consents required to be made under this Agreement, the Ancillary Documents or in connection with the transactions contemplated hereby or thereby. Notwithstanding anything to the contrary in this Section 5.4 or otherwise in this Agreement, the Parties agree that the DYNS Parties, the Sponsor and their respective Representatives may provide general information about the subject matter of this Agreement, the Ancillary Documents and the transactions contemplated hereby and thereby to any direct or indirect current or prospective investor or in connection with normal fund raising or related marketing or informational or reporting activities.

(b) The initial press release concerning this Agreement and the transactions contemplated hereby shall be a joint press release in the form agreed by the Company and DYNS prior to the execution of this Agreement and such initial press release (the “**Signing Press Release**”) shall be released as promptly as reasonably practicable after the execution of this Agreement. Promptly after the execution of this Agreement, DYNS shall file a current report on Form 8-K (the “**Signing Filing**”) with the Signing Press Release and a description of this Agreement as required by, and in compliance with, the Securities Laws, which the Company shall have the opportunity to review and comment upon prior to filing and DYNS shall consider such comments in good faith. The Company, on the one hand, and DYNS, on the other hand, shall mutually agree upon

(such agreement not to be unreasonably withheld, conditioned or delayed by either the Company or DYNS, as applicable) a press release announcing the consummation of the transactions contemplated by this Agreement (the “**Closing Press Release**”) prior to the Closing, and, on the Closing Date, the Parties shall cause the Closing Press Release to be released. Promptly after the Closing (but in any event within four (4) Business Days after the Closing), DYNS shall file a current report on Form 8-K (the “**Closing Filing**”) with the Closing Press Release, a description of the Closing and the required pro forma financial statements and the historical financial statements prepared by the Company and its accountants, in each case, as required by Securities Laws, which the Company shall have the opportunity to review and comment upon prior to filing and DYNS shall consider such comments in good faith. In connection with the preparation of each of the Signing Press Release, the Signing Filing, the Closing Press Release and the Closing Filing, each Party shall, upon written request by any other Party, furnish such other Party with all information concerning itself, its directors, officers and equityholders, and such other matters as may be reasonably necessary for such press release or filing.

Section 5.5 Tax Matters.

(a) The Parties intend that the Merger shall constitute a “reorganization” within the meaning of Section 368(a) of the Code. Each Party shall, and shall cause its respective Affiliates to, use reasonable best efforts to so qualify and shall file all Tax Returns consistent with, and take no position inconsistent with (whether in audits, Tax Returns or otherwise), such treatment unless required to do so pursuant to a “determination” (within the meaning of Section 1313(a) of the Code) that is final. The Parties shall not knowingly take any action that would reasonably be expected to prevent or impede the Intended Tax Treatment.

(b) DYNS and the Company hereby adopt this Agreement as a “plan of reorganization” within the meaning of Treasury Regulations Sections 1.368-2(g) and 1.368-3(a), for purposes of Sections 354, 361 and 368 of the Code.

(c) DYNS and the Company shall cooperate fully, as and to the extent reasonably requested by each of them, in connection with the filing or amendment of any Tax Returns or any audit or other proceeding with respect to Taxes of the Surviving Corporation, and with each other and their respective counsel to document and support the Tax treatment of the Merger in a manner consistent with the Intended Tax Treatment, including by providing factual support letters. Such cooperation shall include the retention and (upon the other’s reasonable request) the provision of records and information which are reasonably relevant to any such Tax Returns or audit or other proceeding and within such Party’s possession or obtainable without material cost or expense, and making employees or other representatives available on a mutually convenient basis to provide additional information and explanation of any material provided hereunder.

Section 5.6 Exclusive Dealing.

(a) During the Interim Period, the Company shall not, and shall cause its Representatives and Affiliates not to, directly or indirectly (i) solicit, initiate, knowingly encourage (including by means of furnishing or disclosing information), knowingly facilitate, discuss or negotiate, directly or indirectly, any inquiry, proposal or offer (written or oral) with respect to a Company Acquisition Proposal, (ii) furnish or disclose any non-public information to any Person (other than to the Parties and their respective Representatives) in connection with, or that would reasonably be expected to lead to, a Company Acquisition Proposal, (iii) enter into any Contract or other arrangement or understanding regarding a Company Acquisition Proposal, (iv) prepare or take any steps in connection with a public offering of any Equity Securities of the Company (or any Affiliate or successor of the Company), or (v) otherwise cooperate in any way with, or assist or participate in, or knowingly facilitate or knowingly encourage any effort or attempt by any Person to do or seek to do any of the foregoing.

(b) The Company shall (i) notify DYNS promptly upon receipt of any Company Acquisition Proposal by the Company, describing the terms and conditions of any such Company Acquisition Proposal in reasonable detail (including the identity of the Person(s) making such Company Acquisition Proposal, unless the Company is bound by any confidentiality obligation entered into prior to the date hereof prohibiting the disclosure of such identity), and (ii) keep DYNS fully informed on a current basis of any modifications to such offer or information.

(c) During the Interim Period, the DYNS Parties shall not, and each of them shall direct their Representatives not to, directly or indirectly (i) solicit, initiate, knowingly encourage (including by means of furnishing or disclosing information), knowingly facilitate, discuss or negotiate, directly or indirectly, any inquiry, proposal or offer (written or oral) with respect to a DYNS Acquisition Proposal, (ii) furnish or disclose any non-public information to any Person (other than to the Parties and their respective Representatives) in connection with, or that would reasonably be expected to lead to, a DYNS Acquisition Proposal, (iii) enter into any Contract or other arrangement or understanding regarding a DYNS Acquisition Proposal, (iv) other than in connection with this Agreement, the Ancillary Documents or the transactions contemplated hereby or thereby, prepare or take any steps in connection with an offering of any securities of any DYNS Party (or any Affiliate or successor of any DYNS Party), or (v) otherwise cooperate in any way with, or assist or participate in, or knowingly facilitate or knowingly encourage any effort or attempt by any Person to do or seek to do any of the foregoing. DYNS agrees to (A) notify the Company promptly upon any DYNS Party obtaining any DYNS Acquisition Proposal, and to describe the terms and conditions of any such DYNS Acquisition Proposal in reasonable detail (including the identity of any Person making such DYNS Acquisition Proposal), and (B) keep the Company reasonably informed on a reasonably current basis of any modifications to such offer or information.

Section 5.7 *Preparation of Registration Statement/Proxy Statement.* As promptly as practicable following the date of this Agreement, (a) DYNS and the Company shall jointly prepare and DYNS shall file with the SEC, mutually acceptable materials which shall include the proxy statement/prospectus (as amended or supplemented from time to time, the “**Proxy Statement/Prospectus**”) to be sent to the

Pre-Closing DYNS Stockholders soliciting proxies from such stockholders to obtain the DYNS Stockholders Approval at the DYNS Stockholders Meeting, and (b) DYNS shall prepare and file with the SEC a registration statement on Form S-4 or such other applicable form, in which the Proxy Statement/Prospectus will be included as a prospectus, in connection with the registration under the Securities Act of, to the extent permitted by the rules and regulations promulgated by the SEC, the Class A Common Stock issuable in connection with the Merger (together with the Proxy Statement/Prospectus, the “**Registration Statement/Proxy Statement**”). Any lodgement or filing fees in connection with the filing of the Registration Statement/Proxy Statement with the SEC shall be borne 50% by the Company and 50% by DYNS. Each of DYNS and the Company shall use its reasonable best efforts to (i) cause the Registration Statement/Proxy Statement to comply in all material respects with the applicable rules and regulations promulgated by the SEC (including, with respect to the Company and its Subsidiaries, by the provision of audited financial statements (in accordance with PCAOB standards) of, and any other information with respect to, the Company and its Subsidiaries for all periods, and in the form, required to be included in the Registration Statement/Proxy Statement under Securities Laws (after giving effect to any waivers received) or in response to any comments from the SEC) and using reasonable best efforts to cause the Company’s auditors to deliver the required audit opinions and consents, and (ii) promptly notify the other Party of, reasonably cooperate with each other with respect to and respond promptly to any comments of the SEC or its staff; and DYNS shall use its reasonable best efforts to (A) have the Registration Statement/Proxy Statement declared effective under the Securities Act as promptly as practicable after it is filed with the SEC, and (B) keep the Registration Statement/Proxy Statement effective through the Closing in order to permit the consummation of the transactions contemplated by this Agreement. DYNS, on the one hand, and the Company, on the other hand, shall promptly furnish, or cause to be furnished, to the other all information concerning such Party and its Representatives that may be required or reasonably requested in connection with any action contemplated by this Section 5.7 or for including in any other statement, filing, notice or application made by or on behalf of DYNS to the SEC or Nasdaq in connection with the transactions contemplated by this Agreement and the Ancillary Documents, including, for the avoidance of doubt, the Company providing for the Registration Statement/Proxy Statement its audited consolidated balance sheets as of December 31, 2021 and December 31, 2020 and its related consolidated statements of income (loss), changes in shareholders’ equity and cash flows for the fiscal years then ended, audited in accordance with applicable PCAOB auditing standards (the “**Additional Company Financial Statements**”), and necessary pro forma financial statements. If any Party becomes aware of any information that should be disclosed in an amendment or supplement to the Registration Statement/Proxy Statement, then (1) such Party shall promptly inform, in the case of any DYNS Party, the Company, or, in the case of the Company, DYNS thereof, (2) such Party shall prepare and mutually agree upon with, in the case of DYNS, the Company, or, in the case of the Company, DYNS (in either case, such agreement not to be unreasonably withheld, conditioned or delayed), an amendment or supplement to the Registration Statement/Proxy Statement, (3) DYNS shall promptly file such mutually agreed upon amendment or supplement with the SEC, and (4) the Parties shall reasonably cooperate, if appropriate, in promptly mailing such

amendment or supplement to the Pre-Closing DYNs Stockholders. The Proxy Statement/Prospectus shall include materials for the adoption and approval by the Pre-Closing DYNs Stockholders of (i) the New ESPP, and (ii) a new equity incentive plan (the “**New Equity Incentive Plan**”), which will initially reserve a number of shares of Class A Common Stock equal to the percentage of the aggregate number of shares of Class A Common Stock issued and outstanding immediately after the Closing (and, for the avoidance of doubt, without accounting for any shares of Class A Common Stock subject to Rollover Options) set forth on Section 5.7 of the Company Disclosure Schedules. The New Equity Incentive Plan will provide for awards of incentive stock options, non-statutory stock options and other stock-based awards (including restricted stock units) as determined by the administrator of the New Equity Incentive Plan in its sole discretion. The Company shall provide a proposed form of the New Equity Incentive Plan within 30 days after the date of this Agreement. DYNs shall have a right to review and approve the New Equity Incentive Plan in advance, such approval not to be unreasonably withheld, conditioned or delayed, and the Parties shall otherwise cooperate to include such terms and conditions as are customary and appropriate for the New Equity Incentive Plan, including a ten (10) year “evergreen” increase provision, pursuant to which the number of shares of Class A Common Stock available for issuance under the New Equity Incentive Plan shall be increased on the first day of each calendar year following the date on which the New Equity Incentive Plan is adopted in an amount equal to the lesser of (x) a percentage of the aggregate number of shares of Class A Common Stock issued and outstanding (and, for the avoidance of doubt, without accounting for any shares of Class A Common Stock then subject to unexercised Rollover Options or outstanding, unexercised options issued pursuant to the New Equity Incentive Plan) as of the last day of the immediately preceding calendar year, and (y) such number of shares of Class A Common Stock as determined by the “Committee” (as defined and designated under the terms of the New Equity Incentive Plan), and with such other parameters as set forth on Section 5.7 of the Company Disclosure Schedules. DYNs shall as promptly as reasonably practicable advise the Company of the time of effectiveness of the Registration Statement/Proxy Statement, the issuance of any stop order relating thereto or the suspension of the qualification of Class A Common Stock for offering or sale in any jurisdiction, and DYNs and the Company shall each use its reasonable best efforts to have any such stop order or suspension lifted, reversed or otherwise terminated. Each of the Parties hereto shall use reasonable best efforts to ensure that none of the information related to it or any of its Representatives, supplied by or on its behalf for inclusion or incorporation by reference in the Registration Statement/Proxy Statement will, at the time the Registration Statement/Proxy Statement is filed with the SEC, at each time at which it is amended, or at the time it becomes effective under the Securities Act, contain any untrue statement of a material fact or omit to state any material fact required to be stated therein or necessary to make the statements therein, in light of the circumstances under which they are made, not misleading.

Section 5.8 *DYNs Stockholder Approval*. As promptly as reasonably practicable following the time at which the Registration Statement/Proxy Statement is declared effective under the Securities Act, DYNs shall (a) duly give notice of, and (b) in any case within thirty (30) days of such effectiveness, duly convene and hold a meeting of its stockholders (the “**DYNs Stockholders Meeting**”) in accordance with the

Governing Documents of DYNS, for the purposes of obtaining the DYNS Stockholder Approval and, if applicable, any approvals related thereto, and providing its stockholders with the opportunity to elect to effect a DYNS Stockholder Redemption. Except as required by applicable Law, DYNS shall, through its board of directors, recommend to its stockholders (i) the adoption and approval of this Agreement and each Ancillary Document to which DYNS is a party and the transactions contemplated hereby and thereby (including the Merger), (ii) the adoption and approval of the issuance of Class A Common Stock in connection with the transactions contemplated by this Agreement, as required by Nasdaq listing requirements, (iii) the adoption and approval of the Required Governing Document Proposals, (iv) the adoption of the New Equity Incentive Plan, (v) the election of directors to be nominated in accordance with Section 5.16, (vi) the adoption and approval of each other proposal that either the SEC or Nasdaq (or the respective staff members thereof) indicates is necessary in its comments to the Registration Statement/Proxy Statement or in correspondence related thereto, (vii) the adoption and approval of each other proposal reasonably agreed by DYNS and the Company as necessary or appropriate in connection with the consummation of the transactions contemplated by this Agreement or the Ancillary Documents, and (viii) the adoption and approval of a proposal for the adjournment of the DYNS Stockholders Meeting, if necessary, to permit further solicitation of proxies because there are not sufficient votes to approve and adopt any of the foregoing (such proposals in clauses (i) through (viii) together, the “**Required Transaction Proposals**”); *provided* that DYNS may postpone or adjourn the DYNS Stockholders Meeting (A) to solicit additional proxies for the purpose of obtaining the DYNS Stockholder Approval, (B) for the absence of a quorum, (C) to allow reasonable additional time for the filing or mailing of any supplemental or amended disclosures that DYNS has determined, based on the advice of outside legal counsel, is reasonably likely to be required under applicable Law and for such supplemental or amended disclosure to be disseminated and reviewed by the Pre-Closing DYNS Stockholders prior to the DYNS Stockholders Meeting, or (D) if the holders of Class A Common Stock have elected to redeem a number of shares of Class A Common Stock as of such time that would reasonably be expected to result in the conditions set forth in Section 6.1(e) or Section 6.3(c) not being satisfied; *provided* that, without the consent of the Company, (i) DYNS may only adjourn the DYNS Stockholders Meeting two (2) times, and (ii) in no event shall DYNS adjourn the DYNS Stockholders Meeting for more than fifteen (15) Business Days later than the most recently adjourned meeting or to a date that is beyond the Termination Date. Except as required by applicable Law, the recommendation of the board of directors of DYNS contemplated by the preceding sentence shall be included in the Registration Statement/Proxy Statement.

Section 5.9 *Merger Sub Stockholder Approval*. As promptly as reasonably practicable (and in any event within one Business Day) following the date of this Agreement, DYNS, as the sole stockholder of Merger Sub, will approve and adopt this Agreement, the Ancillary Documents to which Merger Sub is or will be a party and the transactions contemplated hereby and thereby (including the Merger).

Section 5.10 *Conduct of Business of DYNS*. During the Interim Period, DYNS shall not, except as expressly contemplated by this Agreement or any Ancillary Document (including, for the avoidance of doubt, in connection with the PIPE Financing), as required by applicable Law, as set forth on Section 5.10 of the DYNS Disclosure Schedules, to reasonably comply with any applicable Pandemic Measures or as expressly consented to in writing by the Company (such consent not to be unreasonably withheld, conditioned or delayed if such matter is in furtherance of the transactions contemplated by this Agreement or any Ancillary Document), do any of the following:

(a) seek an approval from the Pre-Closing DYNS Stockholders, or otherwise adopt any amendments, supplements, restatements or modifications to the Trust Agreement or the Governing Documents of any DYNS Party or any of their Subsidiaries;

(b) declare, set aside, make or pay a dividend on, or make any other distribution or payment in respect of, any issued and outstanding Equity Securities of DYNS or any of its Subsidiaries, or repurchase, redeem or otherwise acquire, or offer to repurchase, redeem or otherwise acquire, any issued and outstanding Equity Securities of DYNS or any of its Subsidiaries, as applicable;

(c) split, combine or reclassify any of its capital stock or other Equity Securities or issue any other security in respect of, in lieu of or in substitution for shares of its capital stock;

(d) incur, create, guarantee or assume (whether directly, contingently or otherwise) any Indebtedness, except for Indebtedness for borrowed money in an amount not to exceed \$1,000,000 in the aggregate;

(e) make any loans or advances to, or capital contributions in, any other Person, other than to, or in, DYNS or any of its Subsidiaries;

(f) issue any Equity Securities of DYNS or any of its Subsidiaries or grant any options, warrants or stock appreciation rights with respect to Equity Securities of DYNS or any of its Subsidiaries;

(g) enter into, renew, modify or revise any DYNS Related Party Transaction (or any Contract or agreement that if entered into prior to the execution and delivery of this Agreement would be a DYNS Related Party Transaction), other than the entry into any Contract with a DYNS Related Party with respect to the incurrence of Indebtedness permitted by Section 5.10(d);

(h) engage in any activities or business, or incur any material Liabilities, other than with respect to any activities, business or Liabilities that are (i) either otherwise permitted under this Section 5.10 (including, for the avoidance of doubt, any activities, business or Liabilities contemplated by, or Liabilities incurred in connection with, or that are otherwise incidental or attendant to, this Agreement or any Ancillary Document, the performance of any covenants or agreements hereunder or thereunder or the consummation of the transactions contemplated hereby or thereby) or in accordance with or consented to by the Company pursuant to this Section 5.10, (ii) in connection with or incidental or related to its continuing corporate (or similar) existence or it being (or continuing to be) a public company listed on Nasdaq, or (iii) which are administrative or ministerial in nature and, in the case of this clause (iii), which are not material;

(i) authorize, recommend, propose or announce an intention to adopt, or otherwise effect, a plan of complete or partial liquidation, dissolution, restructuring, recapitalization, reorganization or similar transaction involving DYNS or its Subsidiaries;

(j) enter into any Contract with any broker, finder, investment banker or other Person under which such Person is or will be entitled to any brokerage fee, finder's fee or other commission in connection with the transactions contemplated by this Agreement;

(k) make, change or revoke any material Tax election or material Tax accounting method, file any material Tax Return in a manner inconsistent with past practice, amend any material Tax Return, enter into any agreement with a Governmental Entity with respect to a material amount of Taxes, settle or compromise any claim or assessment by a Governmental Entity in respect of any material amount of Taxes, surrender any right to claim a refund a material amount of Taxes, consent to any extension or waiver of the statutory period of limitation applicable to any material Tax claim or assessment, or enter into any Tax sharing or similar agreement (other than any agreement entered into in the ordinary course of business, the primary purpose of which does not relate to Taxes);

(l) waive, release, compromise, settle or satisfy any pending or threatened material claim (which shall include, but not be limited to, any pending or threatened Proceeding);

(m) make any change in any method of financial accounting or financial accounting principles, policies, procedures or practices except changes that are made (i) in accordance with PCAOB standards, or (ii) as required by any Securities Law or any Order, directive, guideline, recommendation, statement, comment or guidance issued, passed, approved, published, promulgated or released by, the SEC, following reasonable prior consultation with the Company;

(n) make or permit to be made any distribution of amounts held in the Trust Account (other than interest income earned on the funds held in the Trust Account as permitted by the Trust Agreement);

(o) create any new Subsidiary (other than Merger Sub); or

(p) enter into any Contract to take, or cause to be taken, any of the actions set forth in this Section 5.10.

Notwithstanding anything in this Section 5.10 or this Agreement to the contrary, (i) nothing set forth in this Agreement shall give the Company, directly or indirectly, the right to control or direct the operations of DYNS, and (ii) nothing set forth in this Agreement shall prohibit, or otherwise restrict the ability of, DYNS from using the funds held by DYNS outside the Trust Account to pay any DYNS Expenses or any Liabilities of DYNS from otherwise distributing or paying over any funds held by DYNS outside

the Trust Account to the Sponsor or any of its Affiliates, in each case, prior to the Closing; *provided*, that prior to any distribution or payment of any funds to the Sponsor or any of its Affiliates pursuant to the foregoing sentence, DYNS shall cause any Indebtedness of DYNS payable or owing to the Sponsor or any of its Affiliates to be paid in full and discharged with no further Liability or obligation of DYNS.

Section 5.11 *Nasdaq Listing*. From the date hereof through the Effective Time, DYNS shall ensure DYNS remains listed as a public company on Nasdaq. DYNS shall use its reasonable best efforts to, as promptly as reasonably practicable after the date of this Agreement (and in any event, as of immediately prior to or at the Effective Time), (a) cause the Class A Common Stock issuable in accordance with this Agreement to be approved for listing on Nasdaq (and the Company shall reasonably cooperate in connection therewith), subject to official notice of issuance prior to the Effective Time, (b) satisfy any applicable initial and continuing listing requirements of Nasdaq, (c) cause the name of DYNS to be changed to "Senti Biosciences Inc." with effect from the Closing Date, and (d) cause the ticker under which the Class A Common Stock is listed for trading on Nasdaq to be changed to "SNTB" and have the Class A Common Stock listed for trading with such trading ticker.

Section 5.12 *Trust Account*. Upon satisfaction or, to the extent permitted by applicable Law, waiver of the conditions set forth in Article 6 and provision of notice thereof to the Trustee, (a) at the Closing, DYNS shall (i) cause the documents, certificates and notices required to be delivered to the Trustee pursuant to the Trust Agreement to be so delivered, and (ii) make all appropriate arrangements to cause the Trustee to (A) pay as and when due all amounts, if any, payable to the Public Stockholders pursuant to the DYNS Stockholder Redemption, (B) pay the amounts due to the underwriters of DYNS's initial public offering for their deferred underwriting commissions as set forth in the Trust Agreement and (C) immediately thereafter, pay all remaining amounts then available in the Trust Account to DYNS in accordance with the Trust Agreement, and (b) thereafter, the Trust Account shall terminate, except as otherwise provided therein.

Section 5.13 *Company Stockholder Approval*. As promptly as reasonably practicable (and in any event within forty eight (48) hours) following the date that the Registration Statement becomes effective (the "**Company Stockholder Written Consent Deadline**"), the Company shall obtain and deliver to DYNS a true and correct copy of a written consent (in form and substance reasonably satisfactory to DYNS) approving this Agreement, the Ancillary Documents to which the Company is or will be a party and the transactions contemplated hereby and thereby (including the Merger) that is duly executed by the Company Stockholders that hold at least the requisite number of issued and outstanding Company Shares required to approve and adopt such matters in accordance with the DGCL and the Company's Governing Documents (the "**Company Stockholder Written Consent**"). The Company shall recommend to the Company Stockholders the approval and adoption of this Agreement and the Ancillary Documents to which the Company is or will be a party and the transactions contemplated hereby and thereby (including the Merger).

(a) Each Party agrees that (i) all rights to advancement, indemnification, limitations on liability or exculpation now existing in favor of the directors and officers of each DYNs Party, as provided in the applicable DYNs Party's Governing Documents in effect as of immediately prior to the Effective Time, in either case, solely with respect to any acts, errors or omissions occurring on or prior to the Effective Time, shall survive the transactions contemplated by this Agreement and shall continue in full force and effect from and after the Effective Time for a period of six (6) years, and (ii) DYNs will perform and discharge, or cause to be performed and discharged, all obligations to provide such advancement, indemnity, limitations on liability and exculpation during such six (6)-year period. During such six (6)-year period, DYNs shall advance, or caused to be advanced, expenses in connection with such indemnification as provided in the applicable DYNs Party's Governing Documents or other applicable agreements in effect as of the date hereof. The advancement, indemnification and liability limitation or exculpation provisions of the DYNs Parties' Governing Documents or in other applicable agreements in effect as of immediately prior to the Effective Time shall not, during such six (6)-year period, be amended, repealed or otherwise modified after the Effective Time in any manner that would materially and adversely affect the rights thereunder of individuals who, as of immediately prior to the Effective Time or at any time prior to such time, were directors or officers of any DYNs Party (the "**DYNs D&O Persons**") to receive advancement, be so indemnified, have their liability limited or be exculpated with respect to any act, error or omission occurring on or prior to the Effective Time by reason of the fact that such DYNs D&O Person was a director or officer of any DYNs Party prior to the Effective Time, unless such amendment, repeal or other modification is required by applicable Law.

(b) DYNs shall not have any obligation under this Section 5.14 to any DYNs D&O Person when and if a court of competent jurisdiction shall ultimately determine (and such determination shall have become final and non-appealable) that the indemnification of such DYNs D&O Person in the manner contemplated hereby is prohibited by applicable Law.

(c) DYNs shall purchase at or prior to Closing and maintain in effect for a period of six (6) years after the Effective Time, without lapses in coverage, a "tail" policy or policies providing directors' and officers' liability insurance coverage for the benefit of those Persons who are currently covered by any comparable insurance policies of the DYNs Parties as of the date of this Agreement with respect to any acts, errors or omissions occurring on or prior to the Effective Time (the "**DYNs D&O Tail Policy**"). Such "tail" policy or policies shall provide coverage on terms (with respect to coverage and amount) that are substantially the same as (and no less favorable in the aggregate to the insured than) the coverage provided under DYNs's directors' and officers' liability insurance policies as of the date of this Agreement; *provided* that DYNs shall not be required to pay a premium for such "tail" policy or policies in excess of three hundred percent (300%) of the most recent premium paid by DYNs prior to the date of this Agreement and, if the requisite cover is not available for such a premium, DYNs shall purchase the maximum coverage available for three hundred percent (300%) of the most recent premium paid by DYNs prior to the date of this Agreement.

(d) If, following the Closing, DYNS (i) shall merge or consolidate with or merge into any other corporation or entity and shall not be the surviving or continuing corporation or entity of such consolidation or merger, or (ii) shall transfer all or substantially all of its properties and assets as an entity in one or a series of related transactions to any Person, then in each such case, proper provisions shall be made so that the successors or assigns of DYNS shall assume all of the obligations set forth in this Section 5.14.

(e) The DYNS D&O Persons entitled to the advancement, indemnification, liability limitation, exculpation and insurance set forth in this Section 5.14 are intended to be third-party beneficiaries of this Section 5.14. This Section 5.14 shall survive the consummation of the transactions contemplated by this Agreement and shall be binding on all successors and assigns of DYNS.

Section 5.15 Company Indemnification; Directors' and Officers' Insurance.

(a) Each Party agrees that (i) all rights to advancement, indemnification, limitations on liability or exculpation now existing in favor of the directors and officers of the Company and its Subsidiaries, as provided in the Company's and its Subsidiaries' Governing Documents in effect as of immediately prior to the Effective Time, in either case, solely with respect to any acts, errors or omissions occurring on or prior to the Effective Time, shall survive the transactions contemplated by this Agreement and shall continue in full force and effect from and after the Effective Time for a period of six (6) years, and (ii) DYNS will perform and discharge, or cause to be performed and discharged, all obligations to provide such advancement, indemnity, limitations on liability and exculpation during such six (6)-year period. During such six (6)-year period, DYNS shall advance, or caused to be advanced, expenses in connection with such indemnification as provided in the Company's and its Subsidiaries' Governing Documents or other applicable agreements in effect as of the date hereof. The advancement, indemnification and liability limitation or exculpation provisions of the Company's and its Subsidiaries' Governing Documents or in other applicable agreements in effect as of immediately prior to the Effective Time shall not, during such six (6)-year period, be amended, repealed or otherwise modified after the Effective Time in any manner that would materially and adversely affect the rights thereunder of individuals who, as of immediately prior to the Effective Time or at any time prior to such time, were directors or officers of the Company or any of its Subsidiaries (the "**Company D&O Persons**") to receive advancement, be so indemnified, have their liability limited or be exculpated with respect to any act, error or omission occurring on or prior to the Effective Time by reason of the fact that such Company D&O Person was a director or officer of the Company prior to the Effective Time, unless such amendment, repeal or other modification is required by applicable Law.

(b) None of DYNS, the Company or any of its Subsidiaries shall have any obligation under this Section 5.15 to any Company D&O Person when and if a court of competent jurisdiction shall ultimately determine (and such determination shall have become final and non-appealable) that the indemnification of such Company D&O Person in the manner contemplated hereby is prohibited by applicable Law.

(c) The Company shall purchase, at or prior to the Effective Time, and DYNS shall maintain, or cause to be maintained, in effect for a period of six (6) years after the Effective Time, without lapses in coverage, a “tail” policy or policies providing directors’ and officers’ liability insurance coverage for the benefit of those Persons who are currently covered by any comparable insurance policies of the Company or its Subsidiaries immediately prior to the Effective Time with respect to any acts, errors or omissions occurring on or prior to the Effective Time (the “**Company D&O Tail Policy**”). Such Company D&O Tail Policy shall provide coverage on terms (with respect to coverage and amount) that are substantially the same as (and no less favorable in the aggregate to the insured than) the coverage provided under the Company’s or its Subsidiaries’ directors’ and officers’ liability insurance policies in effect immediately prior to the Effective Time; *provided* that the Company shall not pay a premium for such “tail” policy or policies in excess of three hundred fifty percent (350%) of the most recent premium paid by the Company or its Subsidiary prior to the Effective Time and, if the requisite cover is not available for such a premium, the Company shall purchase the maximum coverage available for three hundred fifty percent (350%) of the most recent premium paid by the Company prior to the Effective Time. Notwithstanding the foregoing in this Section 5.15(c), the Company in its sole discretion, in lieu of purchasing the Company D&O Tail Policy, may choose to maintain (and if so chosen, DYNS shall maintain or cause to be maintained) for a period of six (6) years after the Closing, without any lapses in coverage, directors’ and officers’ liability insurance for the benefit of those Persons who are currently covered by any comparable insurance policies of the Company and its Subsidiaries immediately prior to the Effective Time with respect to any acts, errors or omissions occurring on or prior to the Effective Time. Such insurance policies shall provide coverage on terms (with respect to coverage and amount) that are substantially the same as (and no less favorable in the aggregate to the insured than) the coverage provided under the Company’s or its Subsidiaries’ directors’ and officers’ liability insurance policies immediately prior to the Effective Time.

(d) If, following the Closing, DYNS (i) shall merge or consolidate with or merge into any other corporation or entity and shall not be the surviving or continuing corporation or entity of such consolidation or merger, or (ii) shall transfer all or substantially all of its properties and assets as an entity in one or a series of related transactions to any Person, then in each such case, proper provisions shall be made so that the successors or assigns of DYNS shall assume all of the obligations set forth in this Section 5.15.

(e) The Company D&O Persons entitled to the advancement, indemnification, liability limitation, exculpation and insurance set forth in this Section 5.15 are intended to be third-party beneficiaries of this Section 5.15. This Section 5.15 shall survive the consummation of the transactions contemplated by this Agreement and shall be binding on all successors and assigns of DYNS.

Section 5.16 Post-Closing Directors and Officers.

(a) DYNS and the Company shall take, or cause to be taken, all actions as may be necessary or appropriate such that effective immediately after the Effective Time, the DYNS Board shall consist of seven (7) directors. The directors shall be divided into three classes, designated Class I, Class II and Class III, the composition of which shall be determined by mutual agreement between DYNS and the Company following the date of this Agreement. The members of the DYNS Board are the Persons determined in accordance with Section 5.16(b), Section 5.16(c) and Section 5.16(d). The members of the compensation committee, audit committee and nominating committee of the DYNS Board are the Persons determined in accordance with Section 5.16(d). The Officers are the Persons determined in accordance with Section 5.16(e) and if the chief executive officer of the Company is designated as a Company Designee, then he or she is the initial chairperson of the DYNS Board.

(b) The four (4) Persons identified on Section 5.16(b) of the Company Disclosure Schedules shall be directors on the DYNS Board immediately after the Effective Time, with such individuals being in the class of directors determined by mutual agreement between DYNS and the Company following the date of this Agreement and at least one of such individuals being considered an independent director for purposes of the Exchange Act and the rules promulgated thereunder (the “**Company Designees**”). No later than 20 days prior to the effectiveness of the Registration Statement/Proxy Statement, the Company may, subject to applicable listing rules of Nasdaq and applicable Law, replace the Company Designees with any individuals by amending Section 5.16(b) of the Company Disclosure Schedules to include such replacement individuals. DYNS shall take all such action within its power as may be necessary or appropriate to give effect to the Company’s director designations (and its own designations, pursuant to Section 5.16(c)) as of immediately after the Effective Time and for the officers of DYNS (the “**Officers**”) as of immediately after the Effective Time to be the individuals determined in accordance with Section 5.16(e).

(c) Notwithstanding the Company’s designation rights under Section 5.16(b), the two (2) Persons identified on Section 5.16(c) of the DYNS Disclosure Schedules, who shall be nominated by the Sponsor, shall be directors on the DYNS Board immediately after the Effective Time, with such individuals being in the class of directors determined by mutual agreement between DYNS and the Company following the date of this Agreement (provided that at least one DYNS Designee shall be in Class I and one DYNS Designee shall be in Class II) and at least one of such individuals being considered an independent director for purposes of the Exchange Act and the rules promulgated thereunder (the “**DYNS Designees**”). No later than 20 days prior to the effectiveness of the Registration Statement/Proxy Statement, DYNS may, subject to applicable listing rules of Nasdaq and applicable Law, replace the DYNS Designees with any individuals by amending Section 5.16(c) of the DYNS Disclosure Schedules to include such replacement individuals.

(d) Following the date of this Agreement, and no later than 20 days prior to the effectiveness of the Registration Statement/Proxy Statement, the Company and DYNS (on behalf of the Sponsor) shall, subject to applicable listing rules of Nasdaq and applicable Law, consult with each other and agree to (i) designate one (1) Person who shall be a director on the DYNS Board immediately after the Effective Time, with such individual being in the class of directors as determined by the Company and DYNS and

considered an independent director for purposes of the Exchange Act and the rules promulgated thereunder (and, no later than 20 days prior to the effectiveness of the Registration Statement/Proxy Statement, the Company and DYNS may, subject to applicable listing rules of Nasdaq and applicable Law, agree to replace such Person with any individual), and (ii) the members of the DYNS Board, as constituted immediately after the Effective Time, who shall be the members of the compensation committee, audit committee and nominating committee of the DYNS Board immediately after the Effective Time.

(e) The Persons identified on Section 5.16(e) of the Company Disclosure Schedules shall be the Officers immediately after the Effective Time, with each such individual holding the title set forth opposite his or her name. In the event that any Person identified on Section 5.16(e) of the Company Disclosure Schedules is unwilling or unable (whether due to death, disability or otherwise) to serve as an Officer, then, no later than 20 days prior to the effectiveness of the Registration Statement/Proxy Statement, the Company may, subject to applicable listing rules of Nasdaq and applicable Law, replace such individual with another individual to serve as such Officer by amending Section 5.16(e) of the Company Disclosure Schedules to include such replacement individual as such Officer.

(f) At or prior to the Closing, the Company will (i) purchase a policy or policies providing directors' and officers' liability insurance coverage for the benefit of DYNS Designees with respect to any acts, errors or omissions occurring on or following the Effective Time that shall provide coverage on terms (with respect to coverage and amount) that are no less advantageous, in the aggregate, than the coverage and terms provided by a policy held by a similarly situated Person, and (ii) provide the Sponsor (on behalf of the DYNS Designees) with and, subject to the entry into the same by the DYNS Designees, will enter into a director indemnification agreement with the DYNS Designees, in a form and substance approved by the DYNS Board and reasonably acceptable to the Sponsor; *provided*, however, that in no event shall the terms and conditions of any such director indemnification agreement entered into by such DYNS Designee be less favorable to the underlying director than those (if any) entered into by DYNS with any other members of the DYNS Board.

Section 5.17 PIPE Subscriptions.

(a) Unless otherwise approved in writing by the Company, DYNS shall not (other than changes that are solely ministerial) permit any amendment or modification to be made to, permit any waiver (in whole or in part) of, or provide consent to modify (including consent to terminate), any provision or remedy under, or any replacements of, any of the Subscription Agreements, in each case, other than any assignment or transfer expressly permitted thereby (without any further amendment, modification or waiver to such assignment or transfer provision). Subject to the immediately preceding sentence and in the event that all conditions in the Subscription Agreements have been satisfied, DYNS shall use its reasonable best efforts to take, or to cause to be taken, all actions required, necessary or that it otherwise deems to be proper or advisable to consummate the transactions contemplated by the Subscription Agreements on the terms described

therein. Without limiting the generality of the foregoing, DYNS shall give the Company prompt written notice (a) of any requested amendment to any Subscription Agreement, (b) of any breach or default, to the knowledge of DYNS, by any party to any Subscription Agreement, (c) of the receipt of any written notice or other written communication from any party to any Subscription Agreement with respect to any actual, or to the knowledge of DYNS, potential, threatened or claimed expiration, lapse, withdrawal, breach, default, termination or repudiation by any party to any Subscription Agreement or any provisions of any Subscription Agreement, and (d) if DYNS does not expect to receive all or any portion of the applicable purchase price under any Investor's Subscription Agreement in accordance with its terms.

(b) Notwithstanding any other provision of this Agreement, DYNS agrees, for the benefit of the Company, to take all necessary, legally available steps to enforce against any Investor the terms of that Investor's Subscription Agreement if the Investor is in material breach of its obligations thereunder, including any material breach caused by the Investor's failure to fund its Subscription Amount (as defined in its Subscription Agreement) at the time and in the amount required pursuant to its Subscription Agreement.

Section 5.18 *Expense Statement*. At least three (3) Business Days prior to the contemplated Closing Date, DYNS and the Company shall each deliver to the other a written statement setting forth a complete and accurate schedule of its good faith estimate of, in respect of DYNS, each Unpaid DYNS Expense, and in respect of the Company, each Unpaid Company Expense, as of the Closing Date.

Section 5.19 *Transaction Litigation*. During the Interim Period, DYNS, on the one hand, and the Company, on the other hand, shall each notify the other promptly after learning of any stockholder demand (or threat thereof) or other stockholder Proceeding, claim, investigation, examination or inquiry, whether or not before any Governmental Entity (including derivative claims), relating to this Agreement, or any of the transactions contemplated hereby (collectively, "**Transaction Litigation**") commenced or, to the knowledge of DYNS or to the knowledge of the Company, as applicable, threatened in writing against (a) in the case of DYNS, DYNS, any of DYNS's Affiliates or any of their respective Representatives or stockholders (in their capacity as such), or (b) in the case of the Company, the Company, any of the Company's Affiliates or any of their respective Representatives or stockholders (in their capacity as such). DYNS and the Company shall each (i) keep the other reasonably informed regarding any Transaction Litigation, (ii) give the other the opportunity to, at its own cost and expense, participate in the defense, settlement and compromise of any such Transaction Litigation and reasonably cooperate with the other in connection with the defense, settlement and compromise of any such Transaction Litigation, (iii) consider in good faith the other's advice with respect to any such Transaction Litigation, and (iv) reasonably cooperate with each other with respect to any Transaction Litigation; *provided, however*, that in no event shall (x) the Company, any of the Company's Affiliates or any of their respective Representatives settle or compromise any Transaction Litigation without the prior written consent of DYNS (such consent not to be unreasonably withheld, conditioned or delayed) or (y) DYNS, any of DYNS's Affiliates or any of their respective Representatives settle or compromise any Transaction Litigation without the Company's prior written consent (such consent not to be unreasonably withheld, conditioned or delayed).

Section 5.20 *Grant of Options Under New Equity Incentive Plan.* As of the date hereof, the Company has granted to the Persons set forth on Section 5.20 of the Company Disclosure Schedules the number of incentive stock options or non-statutory stock options set forth beside such Person's name, which stock options shall (i) be for a number of shares of Company Common Stock, (ii) have an exercise price of \$1.936, and (iii) vest subject to both (x) the consummation of the transactions contemplated by this Agreement and (y) time-based vesting over four years, with twenty-five percent (25%) of each option time-vesting on the first anniversary of the grant date and the remaining seventy-five percent (75%) of each option time-vesting in thirty-six (36) equal monthly installments thereafter, provided in each case that such person remains in a continuous service relationship with the Company or its Subsidiaries at each applicable vesting date (collectively, the "**Closing Option Awards**").

Section 5.21 *Employee Stock Purchase Plan.* The Company shall provide a proposed form of employee stock purchase plan within 30 days after the date of this Agreement, which will include an initial pool of available shares of Class A Common Stock equal to 1% percent of the aggregate number of shares of Class A Common Stock issued and outstanding immediately after the Closing (and, for the avoidance of doubt, without accounting for any shares of Class A Common Stock subject to Rollover Options) (the "**New ESPP**"). DYNS shall have a right to review and approve the New ESPP in advance, such approval not to be unreasonably withheld, conditioned or delayed, and the Parties shall otherwise cooperate to include such terms and conditions as are customary and appropriate for the New ESPP, including a ten year "evergreen" increase provision, pursuant to which the number of shares of Class A Common Stock available for issuance under the New ESPP shall be increased on the first day of each calendar year following the date on which the New ESPP is adopted in an amount equal to the lesser of (x) 1% of the aggregate number of shares of Class A Common Stock issued and outstanding (and, for the avoidance of doubt, without accounting for any shares of Class A Common Stock then subject to Rollover Options or outstanding options issued pursuant to the New Equity Incentive Plan) as of the last day of the immediately preceding calendar year, and (y) such number of shares of Class A Common Stock as determined by the "Committee" (as defined and designated under the terms of the employee stock purchase plan). Notwithstanding the above, and despite the approval of the New ESPP by DYNS, the parties acknowledge and agree that the implementation of the New ESPP, and any grants thereunder, are subject to review and adoption by the DYNS Board after Closing.

Section 5.22 *Section 280G.* Prior to the Closing Date, the Company shall solicit from each "disqualified individual" (as defined in Section 280G(c) of the Code) a waiver of all payments or other benefits the Company is obligated to pay or provide, that could, in whole or in part, not be deductible under Section 280G of the Code or subject to an excise Tax under Section 4999 of the Code as a result of the transactions contemplated by this Agreement, such that after giving effect to all waivers, the Company would not make or provide any payments or benefits that would not be deductible under Section 280G of

the Code or subject to an excise Tax under Section 4999 of the Code (the payments and benefits waived shall be collectively referred to as the “**Waived 280G Payments**”). Prior to the Closing Date, the Company shall solicit shareholder approval of all Waived 280G Payments in a manner intended to satisfy all applicable requirements of Section 280G(b)(5)(B) of the Code and the Treasury Regulations promulgated thereunder. The form and substance of all stockholder approval documents contemplated by this Section 5.22, including the waivers, shall be subject to the prior review and reasonable approval of DYNs.

Section 5.23 *Company Support Agreements*. During the Interim Period and subject to applicable law, the Company will use commercially reasonable efforts to obtain from all Company Stockholders, who have not previously entered into a Company Support Agreement or Major Holder Support Agreement on the date hereof, Company Support Agreements in the form attached hereto as Exhibit C prior to the Closing.

ARTICLE 6

CONDITIONS TO CONSUMMATION OF THE TRANSACTIONS CONTEMPLATED BY THIS AGREEMENT

Section 6.1 *Conditions to the Obligations of the Parties*. The obligations of the Parties to consummate, or cause to be consummated, the transactions contemplated by this Agreement (including the Closing) are subject to the satisfaction or, if permitted by applicable Law, waiver by the Party for whose benefit such condition exists, of the following conditions:

(a) each applicable waiting period (and any extensions thereof, or any timing agreements, understandings or commitments obtained by request or other action of the United States Federal Trade Commission or the Antitrust Division of the United States Department of Justice, as applicable) or Consent under the HSR Act shall have expired, been terminated or obtained (or deemed, by applicable Law, to have been obtained), as applicable;

(b) no Order or Law issued by any court of competent jurisdiction or other Governmental Entity or other legal restraint or prohibition preventing the consummation of the transactions contemplated by this Agreement (including the Closing) shall be in effect;

(c) the Registration Statement/Proxy Statement shall have become effective in accordance with the provisions of the Securities Act, no stop order shall have been issued by the SEC and shall remain in effect with respect to the Registration Statement/Proxy Statement, and no proceeding seeking such a stop order shall have been threatened or initiated by the SEC and remain pending;

(d) the Company Stockholder Written Consent shall have been obtained;

(e) the approval of the sole stockholder of Merger Sub, as contemplated in Section 5.9;

(f) the DYNs Stockholder Approval shall have been obtained;

(g) DYNs's initial listing application with Nasdaq in connection with the transactions contemplated by this Agreement shall have been approved and, immediately following the Effective Time, DYNs shall be able to satisfy any applicable initial and continuing listing requirements of Nasdaq, and DYNs shall not have received any notice of non-compliance therewith that has not been cured or would not be cured at or immediately following the Effective Time, and the Class A Common Stock (including the Class A Common Stock to be issued hereunder) shall have been approved for listing on Nasdaq, subject only to official notice of issuance thereof; and

(h) after giving effect to the transactions contemplated hereby (including the DYNs Stockholder Redemption and the PIPE Financing), DYNs shall have at least \$5,000,001 of net tangible assets (as determined in accordance with Rule 3a51-1(g)(1) of the Exchange Act) immediately after the Effective Time.

Section 6.2 *Other Conditions to the Obligations of the DYNs Parties*. The obligations of the DYNs Parties to consummate the transactions contemplated by this Agreement (including the Closing) are subject to the satisfaction or, if permitted by applicable Law, waiver by DYNs (on behalf of itself and the other DYNs Parties), of the following further conditions:

(a) (i) the Company Fundamental Representations (other than the representations and warranties set forth in Section 3.2(a) and Section 3.9(a)) shall be true and correct in all material respects (without giving effect to any limitation as to "materiality" or "Company Material Adverse Effect" or any similar limitation set forth therein) as of the Closing Date, as though made on and as of the Closing Date (except to the extent that any such representation and warranty is made as of an earlier date, in which case such representation and warranty shall be true and correct (without giving effect to any limitation as to "materiality" or "Company Material Adverse Effect" or any similar limitation set forth therein) in all material respects as of such earlier date), (ii) the representations and warranties set forth in Section 3.2(a) shall be true and correct in all respects (except for *de minimis* inaccuracies) as of the Closing Date, as though made on and as of the Closing Date (except to the extent that any such representation and warranty is made as of an earlier date, in which case such representation and warranty shall be true and correct in all respects (except for *de minimis* inaccuracies) as of such earlier date), (iii) the representations and warranties set forth in Section 3.9(a) shall be true and correct in all respects as of the Closing Date, as though made on and as of the Closing Date, and (iv) the representations and warranties of the Company set forth in Article 3 (other than the Company Fundamental Representations and the representations and warranties set forth in Section 3.2(a) and Section 3.9(a)) shall be true and correct (without giving effect to any limitation as to "materiality" or "Company Material Adverse Effect" or any similar limitation set forth therein) in all respects as of the Closing Date, as though made on and as of the Closing Date (except to the extent that any such representation and warranty is made as of an earlier date, in which case such representation and warranty shall be true and correct in all respects (without giving effect to any limitation as to "materiality" or "Company Material Adverse Effect" or any similar limitation set forth therein) as of such earlier date), except, in the case of this clause (iii), where the failure of such representations and warranties to be true and correct, taken as a whole, does not, and would not reasonably be expected to, cause a Company Material Adverse Effect;

(b) the Company shall have performed and complied in all material respects with the covenants and agreements required to be performed or complied with by the Company under this Agreement at or prior to the Closing;

(c) since the date of this Agreement, no Company Material Adverse Effect has occurred and is continuing; and

(d) at or prior to the Closing, the Company shall have delivered, or caused to be delivered, to DYNs a certificate duly executed by an authorized officer of the Company, dated as of the Closing Date, to the effect that the conditions specified in Section 6.2(a), Section 6.2(b) and Section 6.2(c) are satisfied, in a form and substance reasonably satisfactory to DYNs.

Section 6.3 *Other Conditions to the Obligations of the Company.* The obligations of the Company to consummate the transactions contemplated by this Agreement (including the Closing) are subject to the satisfaction or, if permitted by applicable Law, waiver by the Company, of the following further conditions:

(a) (i) the DYNs Fundamental Representations (other than the representations and warranties set forth in Section 4.6(a)) shall be true and correct in all material respects (without giving effect to any limitation as to “materiality” or “DYNs Material Adverse Effect” or any similar limitation set forth therein) as of the Closing Date, as though made on and as of the Closing Date (except to the extent that any such representation and warranty is made as of an earlier date, in which case such representation and warranty shall be true and correct in all material respects (without giving effect to any limitation as to “materiality” or “DYNs Material Adverse Effect” or any similar limitation set forth therein) as of such earlier date), (ii) the representations and warranties set forth in Section 4.6(a) shall be true and correct in all respects (except for *de minimis* inaccuracies) as of the Closing Date, as though made on and as of the Closing Date (except to the extent that any such representation and warranty is made of an earlier date, in which case such representation and warranty shall be true and correct in all respects (except for *de minimis* inaccuracies) as of such earlier date), and (iii) the representations and warranties of the DYNs Parties (other than the DYNs Fundamental Representations and the representations and warranties set forth in Section 4.6(a)) contained in Article 4 of this Agreement shall be true and correct (without giving effect to any limitation as to “materiality” or “DYNs Material Adverse Effect” or any similar limitation set forth therein) in all respects as of the Closing Date, as though made on and as of the Closing Date (except to the extent that any such representation and warranty is made as of an earlier date, in which case such representation and warranty shall be true and correct in all respects (without giving effect to any limitation as to “materiality” or “DYNs Material Adverse Effect” or any similar limitation set forth therein) as of such earlier date), except, in the case of this clause (iii), where the failure of such representations and warranties to be true and correct, taken as a whole, does not, and would not reasonably be expected to, cause a DYNs Material Adverse Effect;

(b) the DYNS Parties shall have performed and complied in all material respects with the covenants and agreements required to be performed or complied with by the DYNS Parties under this Agreement at or prior to the Closing;

(c) there being at least \$150,000,000 in Available Closing Cash;

(d) since the date of this Agreement, no DYNS Material Adverse Effect has occurred and is continuing; and

(e) at or prior to the Closing, DYNS shall have delivered, or caused to be delivered, to the Company a certificate duly executed by an authorized officer of DYNS, dated as of the Closing Date, to the effect that the conditions specified in Section 6.3(a) and Section 6.3(b) are satisfied, in a form and substance reasonably satisfactory to the Company

Section 6.4 *Frustration of Closing Conditions*. The Company may not rely on the failure of any condition set forth in this Article 6 to be satisfied if such failure was proximately caused by the Company's or any one of its Subsidiaries' failure to use reasonable best efforts to cause the Closing to occur, as required by Section 5.2, or a material breach of any of its other obligations under this Agreement. None of the DYNS Parties may rely on the failure of any condition set forth in this Article 6 to be satisfied if such failure was proximately caused by any DYNS Party's failure to use reasonable best efforts to cause the Closing to occur, as required by Section 5.2, or a material breach of any of its other obligations under this Agreement.

ARTICLE 7 TERMINATION

Section 7.1 *Termination*. This Agreement may be terminated and the transactions contemplated by this Agreement may be abandoned at any time prior to the Closing:

(a) by mutual written consent of DYNS and the Company;

(b) by DYNS, if any of the representations or warranties set forth in Article 3 shall not be true and correct, or if the Company has failed to perform any covenant or agreement on the part of the Company set forth in this Agreement (including an obligation to consummate the Closing), such that the condition to Closing set forth in either Section 6.2(a) or Section 6.2(b) will not be satisfied and the breach or breaches causing such representations or warranties not to be true and correct, or the failures to perform any covenant or agreement, as applicable, is (or are) not cured or cannot be cured within the earlier of (i) thirty (30) days after written notice thereof is delivered to the Company by DYNS, and (ii) the Termination Date; *provided, however*, that none of the DYNS Parties is then in breach of this Agreement so as to prevent the condition to Closing set forth in either Section 6.3(a) or Section 6.3(b) from being satisfied;

(c) by the Company, if any of the representations or warranties set forth in Article 4 shall not be true and correct, or if any DYNS Party has failed to perform any covenant or agreement on the part of such applicable DYNS Party set forth in this Agreement (including an obligation to consummate the Closing), such that the condition to Closing set forth in either Section 6.3(a) or Section 6.3(b) will not be satisfied and the breach or breaches causing such representations or warranties not to be true and correct, or the failures to perform any covenant or agreement, as applicable, is (or are) not cured or cannot be cured within the earlier of (i) thirty (30) days after written notice thereof is delivered to DYNS by the Company, and (ii) the Termination Date; *provided, however*, that the Company is not then in breach of this Agreement so as to prevent the condition to Closing set forth in Section 6.2(a) or Section 6.2(b) from being satisfied;

(d) by either DYNS or the Company, if the transactions contemplated by this Agreement (including the Closing) shall not have been consummated on or prior to the date which is six (6) months after the date of this Agreement (the “**Termination Date**”); *provided*, that if (x) all of the conditions to the consummation of the Merger set forth in Article 6 (other than the conditions set forth in Section 6.1(e), Section 6.1(f), Section 6.1(g), Section 6.3(c) and those conditions that by their nature are to be satisfied at the Closing) have been satisfied or waived, and (y) the Registration Statement/Proxy Statement has not been declared effective under the Securities Act by the date that is 30 days prior to the Termination Date, then the Termination Date shall automatically be extended by three (3) months to a total of nine (9) months after the date of this Agreement, and such date, as so extended, shall be the Termination Date for all purposes under this agreement; *provided, further*, that (i) the right to terminate this Agreement pursuant to this Section 7.1(d) shall not be available to DYNS if any DYNS Party’s breach of any of its covenants or obligations under this Agreement shall have proximately caused the failure to consummate the transactions contemplated by this Agreement on or before the Termination Date, and (ii) the right to terminate this Agreement pursuant to this Section 7.1(d) shall not be available to the Company if the Company’s breach of its covenants or obligations under this Agreement shall have proximately caused the failure to consummate the transactions contemplated by this Agreement on or before the Termination Date;

(e) by either DYNS or the Company, if any Governmental Entity shall have issued an Order or taken any other action permanently enjoining, restraining or otherwise prohibiting the transactions contemplated by this Agreement and such Order or other action shall have become final and nonappealable;

(f) by either DYNS or the Company, if the DYNS Stockholders Meeting has been held (including any adjournment or postponement thereof), has concluded, DYNS’s stockholders have duly voted and the DYNS Stockholder Approval was not obtained; or

(g) by DYNS, if the Company does not deliver or cause to be delivered to DYNS the Company Stockholder Written Consent in accordance with Section 5.13 on or prior to the Company Stockholder Written Consent Deadline.

Section 7.2 *Effect of Termination*. In the event of the termination of this Agreement pursuant to Section 7.1, this entire Agreement shall forthwith become void (and there shall be no Liability or obligation on the part of the Parties and their respective Representatives) with the exception of (a) Section 5.3(a), this Section 7.2, Article 8 and Article 1 (to the extent related to the foregoing), each of which shall survive such termination and remain valid and binding obligations of the Parties, and (b) the Confidentiality Agreement, which shall survive such termination and remain valid and binding obligations of the parties thereto in accordance with its terms. Notwithstanding the foregoing, the termination of this Agreement pursuant to Section 7.1 shall not affect any Liability on the part of any Party for the Willful Breach of this Agreement by, or any Fraud of, such Party (or in the case of DYNS, DYNS or Merger Sub).

ARTICLE 8 MISCELLANEOUS

Section 8.1 *Non-Survival*. The representations, warranties, agreements and covenants in this Agreement, or in any instrument, document or certificate delivered pursuant to this Agreement, shall terminate at the Effective Time, except for (a) those covenants and agreements that, by their terms, contemplate performance after the Effective Time, and (b) those representations and warranties set forth in Section 3.25, Section 3.27, Section 4.17 and Section 4.18.

Section 8.2 *Entire Agreement; Assignment*. This Agreement (together with the Ancillary Documents and the Confidentiality Agreement) constitutes the entire agreement among the Parties with respect to the subject matter hereof and supersedes all prior agreements, understandings, undertakings, representations and other arrangements, both written and oral, among the Parties with respect to the subject matter hereof. This Agreement may not be assigned by any Party (whether by operation of law or otherwise) without the prior written consent of (a) prior to the Closing, DYNS and the Company, and (b) from and after the Closing, DYNS and the Sponsor. Any attempted assignment of this Agreement not in accordance with the terms of this Section 8.2 shall be void.

Section 8.3 *Amendment*. This Agreement may be amended or modified only (a) prior to the Closing, by a written agreement executed and delivered by DYNS, Merger Sub and the Company, and (b) after the Closing, by a written agreement executed and delivered by DYNS and the Sponsor. This Agreement may not be modified or amended except as provided in the immediately preceding sentence and any purported amendment by any Party or Parties effected in a manner which does not comply with this Section 8.3 shall be void, *ab initio*.

Section 8.4 *Notices*. All notices, requests, claims, demands and other communications hereunder shall be in writing and shall be given (and shall be deemed to have been duly given) by delivery in person, e-mail (having obtained electronic delivery confirmation thereof) or by registered or certified mail (postage prepaid, return receipt requested) (upon receipt thereof) to the other Parties as follows:

(a) If to any DYNS Party, to:

c/o Dynamics Special Purpose Corp.
2875 El Camino Real
Redwood City, CA 94061
Attention: Omid Farokhzad, Mostafa Ronaghi, Mark Afrasiabi
Email: of@dspc.bio, mr@dspc.bio, ma@dspc.bio

with a copy (which shall not constitute notice) to:

Davis Polk & Wardwell LLP
1600 El Camino Real
Menlo Park, CA 94025
Attention: Alan Denenberg, Soren Kreider
Email: alan.denenberg@davispolk.com, w.soren.kreider@davispolk.com

(b) If to the Company, to:

Senti Biosciences, Inc.
2 Corporate Drive, First Floor
South San Francisco, CA 94080
Attention: Timothy Lu, Deb Knobelman, Curt Herberts
Email: tim.lu@sentibio.com, deb.knobelman@sentibio.com, curt.herberts@sentibio.com

with a copy (which shall not constitute notice) to:

Goodwin Procter LLP
100 Northern Avenue
Boston, MA 02210
Attention: Jocelyn M. Arel, Michael R. Patrone
E-mail: jarel@goodwinlaw.com, mpatrone@goodwinlaw.com

or to such other address as the Party to whom notice is given may have previously furnished to the others in writing in the manner set forth above. All such notices, requests, claims, demands and other communications shall be deemed received on the date of receipt by the recipient thereof if received prior to 5:00 p.m. in the place of receipt and such day is a Business Day; otherwise, any such notice, request, claim, demand or other communication shall be deemed not to have been received until the next succeeding Business Day.

Section 8.5 *Governing Law*. This Agreement and all disputes or controversies arising out of or relating to this Agreement or the transactions contemplated hereby, including the applicable statute of limitations, shall be governed by and construed in accordance with the Laws of the State of New York, without giving effect to any choice of law or conflict of law provision or rule (whether of the State of New York or any other jurisdiction) that would cause the application of the Law of any jurisdiction other than the State of New York.

Section 8.6 *Fees and Expenses*. Except as otherwise set forth in this Agreement, all fees and expenses incurred in connection with this Agreement, the Ancillary Documents and the transactions contemplated hereby and thereby, including the fees and disbursements of counsel, financial advisors and accountants, shall be paid by the Party incurring such fees or expenses; *provided* that, for the avoidance of doubt, (a) if this Agreement is terminated in accordance with its terms, the Company shall pay, or cause to be paid, all Unpaid Company Expenses and DYNs shall pay, or cause to be paid, all Unpaid DYNs Expenses, and (b) if the Closing occurs, then DYNs shall pay, or cause to be paid, all Unpaid Company Expenses and all Unpaid DYNs Expenses.

Section 8.7 *Construction; Interpretation*. The term “this Agreement” means this Business Combination Agreement together with the Schedules and Exhibits hereto, as the same may from time to time be amended, modified, supplemented or restated in accordance with the terms hereof. The headings set forth in this Agreement are inserted for convenience only and shall not affect in any way the meaning or interpretation of this Agreement. No Party, nor its respective counsel, shall be deemed the drafter of this Agreement for purposes of construing the provisions hereof, and all provisions of this Agreement shall be construed according to their fair meaning and not strictly for or against any Party. Unless otherwise indicated to the contrary herein by the context or use thereof (a) the words, “herein,” “hereto,” “hereof” and words of similar import refer to this Agreement as a whole, including the Schedules and Exhibits, and not to any particular section, subsection, paragraph, subparagraph or clause set forth in this Agreement, (b) masculine gender shall also include the feminine and neutral genders, and vice versa, (c) words importing the singular shall also include the plural, and vice versa, (d) the words “include,” “includes” or “including” shall be deemed to be followed by the words “without limitation”, (e) references to “\$” or “dollar” or “US\$” shall be references to United States dollars, (f) the word “or” is disjunctive but not necessarily exclusive, (g) the words “writing”, “written” and comparable terms refer to printing, typing and other means of reproducing words (including electronic media) in a visible form, (h) the word “day” means calendar day unless Business Day is expressly specified, (i) the word “extent” in the phrase “to the extent” means the degree to which a subject or other thing extends, and such phrase shall not mean simply “if”, (j) all references to Articles, Sections, Exhibits or Schedules are to Articles, Sections, Exhibits and Schedules of this Agreement, (k) the words “provided” or “made available” or words of similar import (regardless of whether capitalized or not) shall mean, when used with reference to documents or other materials required to be provided or made available to any DYNs Party, any documents or other materials posted to the ShareVault electronic data room maintained by the Company as of 5:00 p.m., Eastern Time, at least one (1) day prior to the date of this Agreement, (l) all references to any Law will be to such Law as amended,

supplemented, restated or otherwise modified or re-enacted from time to time, and (m) all references to any Contract are to such Contract as amended or modified from time to time in accordance with the terms thereof (subject to any restrictions on amendments or modifications set forth in this Agreement). If any action under this Agreement is required to be done or taken on a day that is not a Business Day, then such action shall be required to be done or taken not on such day but on the first succeeding Business Day thereafter.

Section 8.8 *Exhibits and Schedules*. All Exhibits and Schedules, or documents expressly incorporated into this Agreement, are hereby incorporated into this Agreement and are hereby made a part hereof as if set out in full in this Agreement. The Schedules shall be arranged in sections and subsections corresponding to the numbered and lettered Sections and subsections set forth in this Agreement. Any item disclosed in the Company Disclosure Schedules or in the DYNS Disclosure Schedules corresponding to any Section or subsection of Article 3 (in the case of the Company Disclosure Schedules) or Article 4 (in the case of the DYNS Disclosure Schedules) shall be deemed to have been disclosed with respect to every other Section and subsection of Article 3 (in the case of the Company Disclosure Schedules) or Article 4 (in the case of the DYNS Disclosure Schedules), as applicable, where the relevance of such disclosure to such other Section or subsection is reasonably apparent on the face of the disclosure. The information and disclosures set forth in the Schedules that correspond to the Sections or subsections of Article 3 or 4 may not be limited to matters required to be disclosed in the Schedules, and any such additional information or disclosure is for informational purposes only and does not necessarily include other matters of a similar nature.

Section 8.9 *Parties in Interest*. This Agreement shall be binding upon and inure solely to the benefit of each Party and its successors and permitted assigns and, except as provided in Section 5.14, Section 5.15 and the last sentence of this Section 8.9, nothing in this Agreement, express or implied, is intended to or shall confer upon any other Person any rights, benefits or remedies of any nature whatsoever under or by reason of this Agreement. The Sponsor shall be an express third-party beneficiary of Section 8.2, Section 8.3, this Section 8.9, Section 8.13 and Section 8.14.

Section 8.10 *Severability*. Whenever possible, each provision of this Agreement will be interpreted in such a manner as to be effective and valid under applicable Law, but if any term or other provision of this Agreement is held to be invalid, illegal or unenforceable under applicable Law, then all other provisions of this Agreement shall remain in full force and effect so long as the economic or legal substance of the transactions contemplated hereby is not affected in any manner materially adverse to any Party. Upon such determination that any term or other provision of this Agreement is invalid, illegal or unenforceable under applicable Law, the Parties shall negotiate in good faith to modify this Agreement so as to effect the original intent of the Parties as closely as possible in an acceptable manner in order that the transactions contemplated hereby are consummated as originally contemplated to the greatest extent possible.

Section 8.11 *Counterparts; Electronic Signatures; Effectiveness*. This Agreement and each Ancillary Document (including any of the Closing deliverables contemplated hereby) may be executed in two or more counterparts, each of which shall be deemed to be an original, but all of which shall constitute one and the same agreement. Delivery of an executed counterpart of a signature page to this Agreement or any Ancillary Document (including any of the Closing deliverables contemplated hereby) by e-mail, or scanned pages shall be effective as delivery of a manually executed counterpart to this Agreement or any such Ancillary Document or Closing deliverable.

Section 8.12 *Knowledge of Company; Knowledge of DYNS*. For all purposes of this Agreement, the phrase “**to the Company’s knowledge**” and “**known by the Company**” and any derivations thereof shall mean, as of the applicable date, the actual knowledge of the individuals set forth on Section 8.12 of the Company Disclosure Schedules. For all purposes of this Agreement, the phrase “**to DYNS’s knowledge**” and “**to the knowledge of DYNS**” and any derivations thereof shall mean, as of the applicable date, the actual knowledge of the individuals set forth on Section 8.12 of the DYNS Disclosure Schedules. For the avoidance of doubt, none of the individuals set forth on Section 8.12 of the Company Disclosure Schedules or the DYNS Disclosure Schedules shall have any personal Liability or obligations regarding such knowledge.

Section 8.13 *No Recourse*. This Agreement may only be enforced against, and any action for breach of this Agreement or related to the transactions contemplated hereby, may only be made against, the Parties (and then only with respect to the specific obligations of such Parties, as set forth herein), and none of the Representatives of any DYNS Party (including the Sponsor) or the Company (and including the Parties’ stockholders) shall have any Liability arising out of or relating to this Agreement or the transactions contemplated hereby, including with respect to any claim (whether in tort, contract or otherwise) for breach of this Agreement or in respect of any written or oral representations made or alleged to be made in connection herewith, as expressly provided herein.

Section 8.14 *Extension; Waiver*. The Company (prior to the Closing) or the Sponsor (after the Closing) may (a) extend the time for the performance of any of the obligations or other acts of the DYNS Parties set forth herein, (b) waive any inaccuracies in the representations and warranties of the DYNS Parties set forth herein or (c) waive compliance by the DYNS Parties with any of the agreements or conditions set forth herein. DYNS may (i) extend the time for the performance of any of the obligations or other acts of the Company set forth herein, (ii) waive any inaccuracies in the representations and warranties of the Company set forth herein or (iii) waive compliance by the Company with any of the agreements or conditions set forth herein. Any agreement on the part of any such Party to any such extension or waiver shall be valid only if set forth in a written instrument signed on behalf of such Party. Any waiver of any term or condition shall not be construed as a waiver of any subsequent breach or a subsequent waiver of the same term or condition, or a waiver of any other term or condition of this Agreement. The failure of any Party to assert any of its rights, powers or privileges hereunder shall not constitute a waiver of such rights, powers or privileges, nor shall any single or partial exercise thereof preclude any other or further exercise thereof or the exercise of any other right, power or privilege.

Section 8.15 *Waiver of Jury Trial*. THE PARTIES EACH HEREBY WAIVE, TO THE FULLEST EXTENT PERMITTED BY LAW, ANY RIGHT TO TRIAL BY JURY OF ANY PROCEEDING (I) ARISING UNDER THIS AGREEMENT OR UNDER ANY ANCILLARY DOCUMENT, OR (II) IN ANY WAY CONNECTED WITH OR RELATED OR INCIDENTAL TO THE DEALINGS OF THE PARTIES IN RESPECT OF THIS AGREEMENT OR ANY ANCILLARY DOCUMENT OR ANY OF THE TRANSACTIONS RELATED HERETO OR THERETO OR ANY FINANCING IN CONNECTION WITH THE TRANSACTIONS CONTEMPLATED HEREBY OR ANY OF THE TRANSACTIONS CONTEMPLATED THEREBY, IN EACH CASE, WHETHER NOW EXISTING OR HEREAFTER ARISING, AND WHETHER IN CONTRACT, TORT, EQUITY OR OTHERWISE. THE PARTIES EACH HEREBY AGREE AND CONSENT THAT ANY SUCH PROCEEDING SHALL BE DECIDED BY COURT TRIAL WITHOUT A JURY AND THAT THE PARTIES MAY FILE AN ORIGINAL COUNTERPART OF A COPY OF THIS AGREEMENT WITH ANY COURT AS WRITTEN EVIDENCE OF THE CONSENT OF THE PARTIES HERETO TO THE WAIVER OF THEIR RIGHT TO TRIAL BY JURY. EACH PARTY CERTIFIES AND ACKNOWLEDGES THAT (A) NO REPRESENTATIVE, AGENT OR ATTORNEY OF ANY OTHER PARTY HAS REPRESENTED, EXPRESSLY OR OTHERWISE, THAT SUCH OTHER PARTY WOULD NOT, IN THE EVENT OF LITIGATION, SEEK TO ENFORCE THE FOREGOING WAIVER, (B) EACH SUCH PARTY UNDERSTANDS AND HAS CONSIDERED THE IMPLICATIONS OF THIS WAIVER, (C) EACH SUCH PARTY MAKES THIS WAIVER VOLUNTARILY AND (D) EACH SUCH PARTY HAS BEEN INDUCED TO ENTER INTO THIS AGREEMENT BY, AMONG OTHER THINGS, THE MUTUAL WAIVERS AND CERTIFICATIONS IN THIS SECTION 8.15.

Section 8.16 *Submission to Jurisdiction*. Each of the Parties irrevocably and unconditionally submits to the exclusive jurisdiction of the United States District Court for the Southern District of New York and the Supreme Court of the State of New York for the purposes of any Proceeding (a) arising under this Agreement or under any Ancillary Document, or (b) in any way connected with or related or incidental to the dealings of the Parties in respect of this Agreement or any Ancillary Document or any of the transactions contemplated hereby or thereby, and irrevocably and unconditionally waives any objection to the laying of venue of any such Proceeding in any such court, and further irrevocably and unconditionally waives and agrees not to plead or claim in any such court that any such Proceeding has been brought in an inconvenient forum. Each Party hereby irrevocably and unconditionally waives, and agrees not to assert, by way of motion or as a defense, counterclaim or otherwise, in any Proceeding (i) arising under this Agreement or under any Ancillary Document, or (ii) in any way connected with or related or incidental to the dealings of the Parties in respect of this Agreement or any Ancillary Document or any of the transactions contemplated hereby or thereby, (A) any claim that it is not personally subject to the jurisdiction of the courts as described in this Section 8.16 for any reason, (B) that it or its property is exempt or immune from the jurisdiction of any such court or from any Proceeding commenced in such courts (whether through service of notice, attachment prior to judgment, attachment in aid of execution of judgment, execution of judgment or otherwise) and (C) that (x) the

Proceeding in any such court is brought in an inconvenient forum, (y) the venue of such Proceeding is improper or (z) this Agreement, or any Ancillary Document, or the subject matter hereof or thereof, may not be enforced in or by such courts. Each Party agrees that service of any process, summons, notice or document by registered mail to such Party's respective address set forth in Section 8.4 shall be effective service of process for any such Proceeding.

Section 8.17 *Remedies*. Except as otherwise expressly provided herein, any and all remedies provided herein will be deemed cumulative with and not exclusive of any other remedy conferred hereby, or by Law or equity upon such Party, and the exercise by a Party of any one remedy will not preclude the exercise of any other remedy. The Parties agree that irreparable damage, for which monetary damages, even if available, would not be an adequate remedy, would occur in the event that the Parties do not perform their respective obligations under the provisions of this Agreement (including failing to take such actions as are required of them hereunder to consummate the transactions contemplated by this Agreement) in accordance with their specific terms or otherwise breach such provisions. It is accordingly agreed that the Parties shall be entitled to an injunction or injunctions, specific performance and other equitable relief to prevent breaches of this Agreement and to enforce specifically the terms and provisions of this Agreement, in each case, without posting a bond or undertaking and without proof of damages, and this being in addition to any other remedy to which they are entitled at law or in equity. Each of the Parties agrees that it will not oppose the granting of an injunction, specific performance or other equitable relief when expressly available pursuant to the terms of this Agreement on the basis that (a) the other Parties have an adequate remedy at law, or (b) an award of specific performance is not an appropriate remedy for any reason at law or in equity.

Section 8.18 *Trust Account Waiver*. Reference is made to the final prospectus of DYNS, filed with the SEC (File No. 333-255930) on May 27, 2021 (the "**Prospectus**"). The Company acknowledges, agrees and understands that DYNS has established a trust account (the "**Trust Account**") containing the proceeds of its initial public offering (the "**IPO**") and from certain private placements occurring simultaneously with the IPO (including interest accrued from time to time thereon) for the benefit of DYNS's public stockholders (the "**Public Stockholders**") and certain other parties (including the underwriters of the IPO), and DYNS may disburse monies from the Trust Account only in the express circumstances described in the Prospectus. For and in consideration of DYNS entering into this Agreement, and for other good and valuable consideration, the receipt and sufficiency of which are hereby acknowledged, the Company hereby agrees on behalf of itself and its Representatives and Affiliates that, notwithstanding anything to the contrary in this Agreement, none of the Company nor any of its Representatives or Affiliates does now nor shall at any time hereafter have any right, title, interest or claim of any kind in or to any assets held in the Trust Account or distributions therefrom, and shall not make or bring any action, suit, claim or other proceeding against the Trust Account (including in respect of any distributions therefrom), regardless of whether such action, suit, claim or other proceeding arises as a result of, in connection with or relates in any way to, this Agreement, the transactions contemplated hereby or any proposed or actual business relationship between DYNS or

any of its Representatives of Affiliates, on the one hand, and the Company or any of its Representatives or Affiliates, on the other hand, or any other matter, and regardless of whether such action, suit, claim or other proceeding arises based on contract, tort, equity or any other theory of legal liability (any and all such actions, suits, claims or other proceedings are collectively referred to hereafter as the “**Trust Account Released Claims**”). The Company, on its own behalf and on behalf of its Representatives and Affiliates, hereby irrevocably and unconditionally waives any Trust Account Released Claims that it or any of its Representatives or Affiliates may have against the Trust Account (including in respect of any distributions therefrom) now or in the future as a result of, or arising out of, any discussions, negotiations, agreements or Contracts with DYNs or its Representatives or Affiliates, and will not seek recourse against the Trust Account (including in respect of any distributions therefrom) for any reason whatsoever (including for an alleged breach of any agreement with DYNs or its Affiliates).

* * * * *

IN WITNESS WHEREOF, each of the Parties has caused this Business Combination Agreement to be duly executed on its behalf as of the day and year first above written.

DYNAMICS SPECIAL PURPOSE CORP.

By: _____
Name: Mostafa Ronaghi
Title: Chief Executive Officer

EXPLORE MERGER SUB, INC.

By: _____
Name: Mostafa Ronaghi
Title: President

SENTI BIOSCIENCES, INC.

By: _____
Name: Timothy Lu
Title: Chief Executive Officer

[Signature Page to Business Combination Agreement]

INVESTOR RIGHTS AND LOCK-UP AGREEMENT

THIS INVESTOR RIGHTS AND LOCK-UP AGREEMENT (this “**Agreement**”) is entered into as of [•], 2021, by and among Dynamics Special Purpose Corp., a Delaware corporation, (the “**Company**”) and the parties listed as Investors on Schedule I hereto (each, including any person or entity who hereinafter becomes a party to this Agreement pursuant to Section 8.2, an “**Investor**” and collectively, the “**Investors**”). Capitalized terms used but not otherwise defined herein shall have the meanings ascribed to such terms in the Business Combination Agreement (as defined below).

WHEREAS, the Company, Explore Merger Sub, Inc., a Delaware corporation (“**Merger Sub**”) and Senti Biosciences, Inc., a Delaware corporation (“**Senti**”) have entered into that certain Business Combination Agreement, dated as of December 19, 2021 (as amended or supplemented from time to time, the “**Business Combination Agreement**”), pursuant to which, among other things, Merger Sub will merge with and into Senti (the “**Merger**”), with Senti surviving as a wholly owned subsidiary of the Company;

WHEREAS, the Company, Dynamics Sponsor LLC, a Delaware limited liability company (“**Sponsor**”), Omid Farokhzad, Mostafa Ronaghi, Mark Afrasiabi, David Epstein, Jay Flatley, Deep Nishar, Rowan Chapman, Bob Langer and any person or entity who hereafter became or becomes a party to the Prior DYNs Agreement (as defined below) pursuant to Section 6.2 thereof are parties to that certain Registration and Shareholder Rights Agreement, dated May 25, 2021 (the “**Prior DYNs Agreement**”);

WHEREAS, concurrently with the execution of this Agreement, the Company, the Sponsor and certain DYNs Stockholders (such certain DYNs Stockholders, the “**Non-Redemption Investors**”) will enter into non-redemption agreements (the “**Non-Redemption Agreements**”), pursuant to which, among other things (a) such DYNs Stockholders will agree, for the benefit of DYNs, (i) to not exercise their Redemption Rights in respect of (x) the Class A Common Stock beneficially owned by it, or (y) any other shares, capital stock or other equity interests, as applicable, of the Company, which it holds on the date of the Non-Redemption Agreement, (ii) to not, among other things, sell, encumber or otherwise transfer such Class A Common Stock or other shares, capital stock, or equity interests, (b) the Sponsor will agree to forfeit to the Company certain Class B Common Stock which it holds, and (c) the Company will agree to cancel such Class B Common Stock of the Sponsor and concurrently issue to the Pre-Closing DYNs Stockholder an equivalent number of shares of Class A Common Stock, in the case of clauses (b) and (c) above, at or promptly following the consummation of the Merger and, in each case, on the terms and subject to the conditions therein;

WHEREAS, Senti is party to that certain Amended and Restated Investors’ Rights Agreement, dated as of October 22, 2020, by and among Senti and certain investors listed therein (the “**Prior Senti Agreement**” and together with the Prior DYNs Agreement, the “**Prior Agreements**”);

WHEREAS, as of the date of this Agreement, the Sponsor holds 5,750,000 shares of Class B Common Stock of the Company (collectively, the “**Founder Shares**”);

WHEREAS, the Founder Shares will automatically convert into Class A Common Stock at the time of the initial Business Combination (as defined in the Prior DYNs Agreement) on a one-for-one basis, subject to adjustment, on the terms and conditions provided in the DYNs Certificate of Incorporation;

WHEREAS, certain investors (“**Senti Investors**”) hold (a) shares of common stock, par value \$0.001 per share, of Senti (“**Senti Common Stock**”); (b) shares designated as “Series A Preferred Stock” (“**Senti Series A Preferred Stock**”); and (c) shares designated as “Series B Preferred Stock” (“**Senti Series B Preferred Stock**”, and together with Senti Common Stock, Senti Series A Preferred Stock, and Senti Series B Preferred Stock, the “**Senti Shares**”);

WHEREAS, the Senti Shares will be exchanged for Class A Common Stock on or about the date hereof, pursuant to the Business Combination Agreement;

WHEREAS, certain Investors have subscribed to purchase shares of Class A Common Stock in the PIPE Financing (as defined in the Business Combination Agreement) in connection with the consummation of the Merger; and

WHEREAS, DYNs and Senti desire to terminate the Prior Agreements to provide for the terms and conditions included herein.

NOW, THEREFORE, in consideration of the mutual covenants and agreements set forth herein, and for other good and valuable consideration, the receipt and sufficiency of which are hereby acknowledged, the parties hereto agree as follows:

1. **DEFINITIONS.** The following capitalized terms used herein have the following meanings:

“**Addendum Agreement**” is defined in [Section 8.2](#).

“**Adverse Disclosure**” mean public disclosure of any material nonpublic information which, in the good faith reasonable determination of the board of directors of the Company, (i) would be required to be made in any Registration Statement filed with the SEC by the Company so that such Registration Statement, from and after its effective date, does not contain an untrue statement of a material fact or omit to state a material fact required to be stated therein or necessary to make the statements therein not misleading; (ii) would not be required to be made at such time but for the filing, effectiveness or continued use of such Registration Statement; and (iii) the Company has a bona fide business purpose for not disclosing publicly and would reasonably be likely to be detrimental to the Company and its subsidiaries.

“**Agreement**” is defined in the preamble to this Agreement.

“**Block Trade**” means any non-marketed underwritten offering taking the form of a block trade to financial institutions, QIBs or Institutional Accredited Investors, bought deals, over-night deals or similar transactions that do not include “road show” presentations to potential investors requiring marketing effort from management over multiple days.

“**Business Combination Agreement**” is defined in the preamble to this Agreement.

“**Business Day**” means a day other than a Saturday, Sunday or other day on which commercial banks in New York, New York are authorized or required by law to close.

“**Class A Common Stock**” is defined in the recitals to this Agreement.

“**Closing Date**” is defined in the Business Combination Agreement.

“**Commission**” means the Securities and Exchange Commission, or any other Federal agency then administering the Securities Act or the Exchange Act.

“**Company**” is defined in the preamble to this Agreement.

“**Company Board**” is defined in [Section 3.1.1](#).

“**Demand Registration**” is defined in [Section 2.2.1](#).

“**Demanding Holder**” is defined in [Section 2.2.1](#).

“**DYNS Certificate of Incorporation**” means the Amended and Restated Certificate of Incorporation of DYNS Special Purpose Corp., effective as of May 25, 2021.

“**DYNS Investors**” shall mean the investors listed on [Schedule I](#) hereto, together with any of their respective Permitted Transferees.

“**Effectiveness Period**” is defined in [Section 3.1.3](#).

“**Exchange Act**” means the Securities Exchange Act of 1934, as amended, and the rules and regulations of the Commission promulgated thereunder, all as the same shall be in effect at the time.

“**Form 10 Disclosure Filing Date**” means the date on which the Company shall file with the Commission a Current Report on Form 8-K that includes current “Form 10 information” (within the meaning of Rule 144) reflecting the Company’s status as an entity that is no longer an issuer described in paragraph (i)(1)(i) of Rule 144.

“**Form S-1**” means a Registration Statement on Form S-1.

“**Form S-3**” means a Registration Statement on Form S-3 or any similar short-form registration that may be available at such time.

“**Founder Shares**” is defined in the recitals to this Agreement.

“**Indemnified Party**” is defined in [Section 4.3](#).

“**Indemnifying Party**” is defined in [Section 4.3](#).

“**Initiating Holder**” is defined in [Section 2.1.6](#).

“**Institutional Accredited Investor**” means an institutional “accredited” investor as defined in Rule 501(a) of Regulation D under the Securities Act.

“**Investor**” is defined in the preamble to this Agreement.

“**Investor Indemnified Party**” is defined in [Section 4.1](#).

“**Lock-up Release Date**” means, for purposes of this Agreement for certain Investors as set forth on Schedule II to this agreement, (I)(i) the earliest of (A) the one year anniversary of the Closing and (B) subsequent to the Closing, (x) if the last reported sale price of the Class A Common Stock equals or exceeds \$12.00 per share (as adjusted for stock splits, stock dividends, reorganizations, recapitalizations and the like) for any 20 trading days within any 30 consecutive trading day period commencing at least 150 days after the Closing, or (ii) the earliest of (A) the eighteen (18) month anniversary of the Closing and (B) subsequent to the Closing, (x) if the last reported sale price of the Class A Common Stock equals or exceeds \$12.00 per share (as adjusted for stock splits, stock dividends, reorganizations, recapitalizations and the like) for any 20 trading days within any 30 consecutive trading day period commencing at least 330 days after the Closing, or (II) the date upon completion of a liquidation, merger, stock exchange, reorganization or other similar transaction that results in all of the public stockholders of Parent having the right to exchange their DYNS Common Stock for cash, securities or other property.

“**Maximum Number of Shares**” is defined in [Section 2.2.4](#).

“**New Registration Statement**” is defined in [Section 2.1.4](#).

“**New Securities**” means all shares of Class A Common Stock issued in connection with the Merger.

“**Notices**” is defined in [Section 8.5](#).

“**Permitted Transferee**” means (i) the members of an Investor’s immediate family (for purposes of this Agreement, “**immediate family**” shall mean with respect to any natural person, any of the following: such person’s spouse, the siblings of such person and his or her spouse, and the direct descendants and ascendants (including adopted and step children and parents) of such person and his or her spouses and siblings); (ii) any trust or family limited liability company or partnership for the direct or indirect benefit of an Investor or the immediate family of an Investor; (iii) if an Investor is a trust, to the trustor or beneficiary of such trust or to the estate of a beneficiary of such trust; (iv) any officer, director, general partner, limited partner, shareholder, member, or owner of similar equity interests in an Investor; or (v) any affiliate of an Investor.

“**Piggy-Back Registration**” is defined in [Section 2.3.1](#).

“**Prior Agreements**” is defined in the preamble to this Agreement.

“**Prior DYNS Agreement**” is defined in the preamble to this Agreement.

“**Prior Senti Agreement**” is defined in the preamble to this Agreement.

“**Pro Rata**” is defined in [Section 2.2.4](#).

“**QIB**” means “qualified institutional buyer” as defined in Rule 144A under the Securities Act.

“**Registrable Securities**” means (i) New Securities and, for Investors other than the Non-Redemption Investors, shares of Class A Common Stock issued in the PIPE Financing and (ii) all shares of Class A Common Stock issued to any Investor with respect to such securities referenced in clause (i) by way of any share split, share dividend or other distribution, recapitalization, share exchange, share reconstruction, amalgamation, contractual control arrangement or similar event. As to any particular Registrable Securities, such securities shall cease to be Registrable Securities when: (a) a Registration Statement with respect to the sale of such securities shall have become effective under the Securities Act and such securities shall have been sold, transferred, disposed of or exchanged in accordance with such Registration Statement; (b) such securities shall have been otherwise transferred, new certificates for such securities not bearing a legend restricting further transfer shall have been delivered by the Company and subsequent public distribution of such securities shall not require registration under the Securities Act; or (c) such securities shall have ceased to be outstanding.

“**Registration**” means a registration effected by preparing and filing a registration statement or similar document in compliance with the requirements of the Securities Act, and the applicable rules and regulations promulgated thereunder, and such registration statement becoming effective.

“**Registration Statement**” means a registration statement filed by the Company with the Commission in compliance with the Securities Act and the rules and regulations promulgated thereunder for a public offering and sale of equity securities, or securities or other obligations exercisable or exchangeable for, or convertible into, equity securities (other than a registration statement on Form S-4 or Form S-8, or their successors, or any registration statement covering only securities proposed to be issued in exchange for securities or assets of another entity).

“**Resale Shelf Registration Statement**” is defined in [Section 2.1.1](#).

“**Rule 415 Notice**” is defined in [Section 2.1.4](#).

“**SEC Guidance**” is defined in [Section 2.1.4](#).

“**Securities Act**” means the Securities Act of 1933, as amended, and the rules and regulations of the Commission promulgated thereunder, all as the same shall be in effect at the time.

“**Senti Common Stock**” is defined in the recitals to this Agreement.

“**Senti Investors**” is defined in the recitals to this Agreement.

“**Senti Series A Preferred Stock**” is defined in the recitals to this Agreement.

“**Senti Series B Preferred Stock**” is defined in the recitals to this Agreement.

“**Senti Shares**” is defined in the recitals to this Agreement.

“**Shelf Participant**” is defined in Section 2.1.6.

“**Takedown Demand**” is defined in Section 2.1.6.

“**Transfer**” means to (i) sell, offer to sell, contract or agree to sell, hypothecate, pledge, grant any option to purchase or otherwise dispose of or agree to dispose of, directly or indirectly, or establish or increase a put equivalent position or liquidate or decrease a call equivalent position within the meaning of Section 16 of the Exchange Act, and the rules and regulations of the Commission promulgated thereunder, with respect to any shares of Class A Common Stock, (ii) enter into any swap or other arrangement that transfers to another, in whole or in part, any of the economic consequences of ownership of any shares of Class A Common Stock, whether any such transaction is to be settled by delivery of such securities, in cash or otherwise, or (iii) publicly announce any intention to effect any transaction, including the filing of a registration statement specified in clause (i) or (ii), other than a Registration Statement filed pursuant to this Agreement. Notwithstanding the foregoing, a Transfer shall not be deemed to include any transfer for no consideration if the donee, trustee, heir or other transferee has agreed in writing to be bound by the same terms under this Agreement to the extent and for the duration that such terms remain in effect at the time of the Transfer.

“**Underwriter**” means a securities dealer who purchases any Registrable Securities as principal in an underwritten offering and not as part of such dealer’s market-making activities.

“**Underwritten Demand Registration**” shall mean an underwritten public offering of Registrable Securities pursuant to a Demand Registration, as amended or supplemented, that is a fully marketed underwritten offering that requires Company management to participate in “road show” presentations to potential investors requiring substantial marketing effort from management over multiple days, the issuance of a “comfort letter” by the Company’s auditors, and the issuance of legal opinions by the Company’s legal counsel.

“**Underwritten Takedown**” shall mean an underwritten public offering of Registrable Securities pursuant to the Resale Shelf Registration Statement, as amended or supplemented, that requires the issuance of a “comfort letter” by the Company’s auditors and the issuance of legal opinions by the Company’s legal counsel.

2. REGISTRATION RIGHTS.

2.1 Resale Shelf Registration Rights.

2.1.1 Registration Statement Covering Resale of Registrable Securities. Provided compliance by the Investors with Section 3.4, the Company shall prepare and file or cause to be prepared and filed with the Commission, as soon as reasonably practical, but in no event later than twenty (20) calendar days following the Closing Date, a Registration Statement on Form S-3 or its successor form, or, if the Company is ineligible to use Form S-3, a Registration Statement on Form S-1, for an offering to be made on a continuous basis pursuant to Rule 415 of the Securities Act registering the resale from time to time by Investors of all of the Registrable Securities then held by such Investors that are not covered by an effective resale registration statement (the “**Resale Shelf Registration Statement**”). The Company shall use commercially reasonable efforts to cause the Resale Shelf Registration Statement to be declared effective as soon as possible after filing, and in no event later than the earlier of (x) 60th calendar day after the Closing (or 90th calendar day if the SEC notifies (orally or in writing, whichever is earlier) the Company that it will “review” the Resale Shelf Registration Statement) and, (y) the 5th Business Day after the Company is notified (orally or in writing, whichever is earlier) by the SEC that the Resale Shelf Registration Statement will not be “reviewed” or will not be subject to further review. Once effective the Company shall use commercially reasonable efforts to keep the Resale Shelf Registration Statement continuously effective under the Securities Act at all times until the expiration of the Effectiveness Period (as defined below). In the event that the Company files a Form S-1 pursuant to this Section 2.1, the Company shall use its commercially reasonable efforts to convert the Form S-1 to a Form S-3 promptly after the Company is eligible to use Form S-3. The Resale Shelf Registration Statement shall provide that the Registrable Securities may be sold pursuant to any method or combination of methods legally available to, and requested by, the Investors, including the registration of the distribution to its shareholders, partners, members or other affiliates. Without limiting the foregoing, subject to any comments from the Commission, each Registration Statement filed pursuant to this Section 2.1.1 shall include a “plan of distribution” approved by Senti Investors holding a majority of the Registrable Securities.

2.1.2 Notification and Distribution of Materials. The Company shall promptly notify the Investors in writing of the effectiveness of the Resale Shelf Registration Statement and shall furnish to them, without charge, such number of copies of the Resale Shelf Registration Statement (including any amendments, supplements and exhibits), the prospectus contained therein (including each preliminary prospectus and all related amendments and supplements) and any documents incorporated by reference in the Resale Shelf Registration Statement or such other documents as the Investors may reasonably request in order to facilitate the sale of the Registrable Securities in the manner described in the Resale Shelf Registration Statement.

2.1.3 Amendments and Supplements. Subject to the provisions of Section 2.1.1 above, the Company shall promptly prepare and file with the Commission from time to time such amendments and supplements to the Resale Shelf Registration Statement and prospectus used in connection therewith as may be necessary to keep the Resale Shelf Registration Statement effective and to comply with the provisions of the Securities Act with respect to the disposition of all the Registrable Securities during the Effectiveness Period (as defined below).

2.1.4 Reduction of Shelf Offering. Notwithstanding the registration obligations set forth in this Section 2.1, in the event the Commission informs the Company (the “**Rule 415 Notice**”) that all of the Registrable Securities cannot, as a result of the application of Rule 415, be registered for resale as a secondary offering on a single registration statement, the Company agrees to promptly (i) inform each of the holders thereof and use its commercially reasonable

efforts to file an amendment or amendments to the Resale Shelf Registration Statement as required by the Commission and/or (ii) withdraw the Resale Shelf Registration Statement and file a new registration statement (a "**New Registration Statement**"), in either case covering the maximum number of Registrable Securities permitted to be registered by the Commission, on Form S-1, Form S-3 or such other form available to register for resale the Registrable Securities as a secondary offering; provided, however, that prior to filing such amendment or New Registration Statement, the Company shall be obligated to use its commercially reasonable efforts to advocate with the Commission for the registration of all of the Registrable Securities in accordance with any publicly-available written or oral guidance, comments, requirements or requests of the Commission staff (the "**SEC Guidance**"), including, without limitation, Compliance and Disclosure Interpretation 612.09. Notwithstanding any other provision of this Agreement, if any SEC Guidance sets forth a limitation of the number of Registrable Securities permitted to be registered on a particular Registration Statement as a secondary offering (and notwithstanding that the Company used diligent efforts to advocate with the Commission for the registration of all or a greater number of Registrable Securities), unless otherwise directed in writing by a holder as to its Registrable Securities, the number of Registrable Securities to be registered on such Registration Statement will be reduced on a Pro Rata basis, subject to a determination by the Commission that certain Investors must be reduced first based on the number of Registrable Securities held by such Investors. In the event the Company amends the Resale Shelf Registration Statement or files a New Registration Statement, as the case may be, under clauses (i) or (ii) above, the Company will use its commercially reasonable efforts to file with the Commission, as promptly as allowed by Commission or SEC Guidance provided to the Company or to registrants of securities in general, one or more registration statements on Form S-1, Form S-3 or such other form available to register for resale those Registrable Securities that were not registered for resale on the Resale Shelf Registration Statement, as amended, or the New Registration Statement. If the Company shall not be able to register for resale all of the Registrable Securities on the Resale Shelf Registration Statement within three (3) months following the date of the Company's receipt of the Commission's Notice, then, until such Resale Shelf Registration Statement is effective, each of the Senti Investors shall be entitled to demand registration rights pursuant to Section 2.2 below as long as the demand request is a proposal to sell Registrable Securities with an aggregate market price at the time of request of not less than \$5,000,000 (the "**Shelf Demand Right**"). Shelf Demand Rights shall not be counted as Demand Registrations under Section 2.2.

No Investor shall be named as an "underwriter" in any Registration Statement filed pursuant to this Section 2 without the Investor's prior written consent; provided that if the Commission requests that an Investor be identified as a statutory underwriter in the Registration Statement, then such Investor will have the option, in its sole and absolute discretion, to either (i) have the opportunity to withdraw from the Registration Statement upon its prompt written request to the Company, in which case the Company's obligation to register such Investor's Registrable Securities shall be deemed satisfied or (ii) be included as such in the Registration Statement. Each Registration Statement (and each amendment or supplement thereto, and each request for acceleration of effectiveness thereof) shall be provided to (and shall be subject to the approval, which shall not be unreasonably withheld or delayed, of) the Investors prior to its filing with, or other submission to, the Commission.

2.1.5 Notice of Certain Events. The Company shall promptly notify the Investors in writing of any request by the Commission for any amendment or supplement to, or additional information in connection with, the Resale Shelf Registration Statement required to be prepared and filed hereunder (or prospectus relating thereto). The Company shall promptly notify each Investor, or their representatives, in writing of the filing of the Resale Shelf Registration Statement or any prospectus, amendment or supplement related thereto or any post-effective amendment to the Resale Shelf Registration Statement and the effectiveness of any post-effective amendment.

2.1.6 Underwritten Takedown. If the Company shall receive a request (a “**Takedown Demand**”) from the (i) holders of Registrable Securities with an estimated market value of at least \$5,000,000 or (ii) the holders of Registrable Securities registered under the Resale Shelf Registration Statement that own in the aggregate at least 5% of the outstanding Class A Common Stock requesting a registration of at least \$5,000,000 (either an “**Initiating Holder**”) that the Company effect an Underwritten Takedown of all or any portion of the requesting holder’s Registrable Securities covered under the Resale Shelf Registration Statement, then the Company shall give (x) in connection with any non-marketed underwritten takedown offering (other than a Block Trade), at least two (2) Business Days’ notice of such Takedown Demand to each holder of Registrable Securities (other than the Initiating Holder) that is a participant in the Resale Shelf Registration Statement (“**Shelf Participant**”), (y) in connection with any Block Trade initiated, notice of such Underwritten Takedown to each holder of Registrable Securities (other than the Initiating Holder) that is a Shelf Participant no later than noon Eastern time on the Business Day prior to the requested Underwritten Takedown and (z) in connection with any marketed Underwritten Takedown, at least five (5) Business Days’ notice of such Underwritten Takedown to each holder of Registrable Securities (other than the Initiating Holder) that is a Shelf Participant. In connection with (x) any non-marketed Underwritten Takedown initiated and (y) any marketed Underwritten Takedown, if any Shelf Participants entitled to receive a notice pursuant to the preceding sentence request inclusion of their Registrable Securities covered by the Resale Shelf Registration Statement (by written notice to the Company, which notice must be received by the Company no later than (A) in the case of a non-marketed Underwritten Takedown (other than a Block Trade), the Business Day following the date notice is given to such participant, (B) in the case of a Block Trade, by 10:00 p.m. Eastern time on the date notice is given to such participant and (C) in the case of a marketed Underwritten Takedown, three (3) Business Days following the date notice is given to such participant), the Initiating Holder and the other Shelf Participants that request inclusion of their Registrable Securities shall be entitled to sell their Registrable Securities in such offering. Thereupon the Company shall use its commercially reasonable efforts to effect, as expeditiously as possible, the offering in such Underwritten Takedown of:

(i) subject to the restrictions set forth in Section 2.2.4, all Registrable Securities for which the Initiating Holder has requested such offering under Section 2.1.6, and

(ii) subject to the restrictions set forth in Section 2.2.4, all other Registrable Securities that any holders of Registrable Securities covered under the Resale Registration Shelf Statement have requested the Company to offer by request received by the Company in the requisite time period, all to the extent necessary to permit the disposition (in accordance with the intended methods thereof as aforesaid) of the Registrable Securities so to be offered.

(a) Promptly after the expiration of the relevant time period, the Company will promptly notify all selling holders of the identities of the other selling holders and the number of shares of Registrable Securities requested to be included therein.

(b) the Company shall only be required to effectuate, within any twelve (12) month period, one Underwritten Takedown by each of (A) the DYNs Investors, collectively, and (B) Senti Investors, collectively.

2.1.7 Block Trade. If the Company shall receive a request from the holders of Registrable Securities with an estimated market value of at least \$5,000,000 that the Company effect the sale of all or any portion of the Registrable Securities in a Block Trade, then the Company shall, as expeditiously as possible, initiate the offering in such Block Trade of the Registrable Securities for which such requesting holder has requested such offering under Section 2.1.7.

2.1.8 Selection of Underwriters. The Initiating Holder(s) shall have the right to select an Underwriter or Underwriters in connection with such Underwritten Takedown, which Underwriter or Underwriters shall be reasonably acceptable to the Company. In connection with an Underwritten Takedown, the Company shall enter into customary agreements (including an underwriting agreement in customary form) and take such other actions as are reasonably required in order to expedite or facilitate the disposition of the Registrable Securities in such Underwritten Takedown, including, if necessary, the engagement of a “qualified independent underwriter” in connection with the qualification of the underwriting arrangements with the Financial Industry Regulatory Authority, Inc.

2.1.9 Underwritten Takedowns effected pursuant to this Section 2.1 shall not be counted as Demand Registrations effected pursuant to Section 2.2.

2.2 Demand Registration

2.2.1 Request for Registration. At any time and from time to time after the expiration of any lock-up to which an Investor’s shares are subject, if any, provided compliance by the Investors with Section 3.4, and provided further there is not an effective Resale Shelf Registration Statement available for the resale of all of the Registrable Securities pursuant to Section 2.1 (and subject to the right of holders to effect Underwritten Takedowns under Section 2.1), (i) DYNs Investors who hold a majority of the Registrable Securities held by all DYNs Investors or (ii) Senti Investors who hold either a majority of the Registrable Securities held by all Senti Investors, may make a written demand for Registration under the Securities Act of all or any portion of their Registrable Securities on Form S-1 or any similar long-form Registration or, if then available, on Form S-3. Each registration requested pursuant to this Section 2.2.1 is referred to herein as a “**Demand Registration**”. Any demand for a Demand Registration shall specify the number of shares of Registrable Securities proposed to be sold and the intended

method(s) of distribution thereof. The Company will within five (5) Business Days after receiving such demand, notify all Investors that are holders of Registrable Securities of the demand, and each such holder of Registrable Securities who wishes to include all or a portion of such holder's Registrable Securities in the Demand Registration (each such holder including shares of Registrable Securities in such registration, a "**Demanding Holder**") shall so notify the Company within five (5) Business Days after the receipt by the holder of the notice from the Company. Upon any such request, the Demanding Holders shall be entitled to have their Registrable Securities included in the Demand Registration, subject to [Section 2.2.4](#) and the provisos set forth in [Section 3.1.1](#). The Company shall not be obligated to effect: (a) more than two (2) Demand Registration during any twelve-month period (not including any Underwritten Takedown); (b) any Demand Registration at any time there is an effective Resale Shelf Registration Statement on file with the Commission pursuant to [Section 2.1](#) that is not subject to a reduction of registered shares under [Section 2.1.4](#) (and subject to the obligation to effect Underwritten Takedowns as set forth in [Section 2.1](#)); or (c) more than two (2) Underwritten Demand Registrations in respect of all Registrable Securities held by DYNs Investors.

2.2.2 Effective Registration. A Registration will not count as a Demand Registration until the Registration Statement filed with the Commission with respect to such Demand Registration has been declared effective and the Company has complied with all of its obligations under this Agreement with respect thereto; provided, however, that if, after such Registration Statement has been declared effective, the offering of Registrable Securities pursuant to a Demand Registration is interfered with by any stop order or injunction of the Commission or any other governmental agency or court, the Registration Statement with respect to such Demand Registration will be deemed not to have been declared effective, unless and until, (i) such stop order or injunction is removed, rescinded or otherwise terminated, and (ii) a majority-in-interest of the Demanding Holders thereafter elect to continue the offering; provided, further, that the Company shall not be obligated to file a second Registration Statement until a Registration Statement that has been filed is counted as a Demand Registration or is terminated.

2.2.3 Underwritten Demand Registration. If the Demanding Holders so elect and such holders so advise the Company as part of their written demand for a Demand Registration, the offering of such Registrable Securities pursuant to such Demand Registration shall be in the form of an Underwritten Demand Registration. In such event, the right of any holder to include its Registrable Securities in such registration shall be conditioned upon such holder's participation in such underwriting and the inclusion of such holder's Registrable Securities in the underwriting to the extent provided herein. All Demanding Holders proposing to distribute their Registrable Securities through such underwriting shall enter into an underwriting agreement in customary form with the Underwriter or Underwriters selected for such underwriting by the holders initiating the Demand Registration, and subject to the approval of the Company. The parties agree that, in order to be effected, any Underwritten Demand Registration must result in aggregate proceeds to the selling shareholders of at least \$5,000,000.

2.2.4 Reduction of Offering. If the managing Underwriter or Underwriters for a Underwritten Demand Registration that is to be an underwritten offering advises the Company and the Demanding Holders in writing that, in such Underwriter's or Underwriters' opinion, the dollar amount or number of shares of Registrable Securities which the Demanding Holders

desire to sell, taken together with all other shares of Class A Common Stock or other securities which the Company desires to sell and the shares of Class A Common Stock, if any, as to which registration has been requested pursuant to written contractual piggy-back registration rights held by other shareholders of the Company who desire to sell, exceeds the maximum dollar amount or maximum number of shares that can be sold in such offering without adversely affecting the proposed offering price, the timing, the distribution method, or the probability of success of such offering (such maximum dollar amount or maximum number of shares, as applicable, the “**Maximum Number of Shares**”), then the Company shall include in such registration: (i) first, the Registrable Securities as to which Demand Registration has been requested by the Demanding Holders (pro rata in accordance with the number of shares that each such person has requested be included in such registration, regardless of the number of shares held by each such person (such proportion is referred to herein as “**Pro Rata**”)) that can be sold without exceeding the Maximum Number of Shares; (ii) second, to the extent that the Maximum Number of Shares has not been reached under the foregoing clause (i), the shares of Class A Common Stock or other securities that the Company desires to sell that can be sold without exceeding the Maximum Number of Shares; and (iii) third, to the extent that the Maximum Number of Shares has not been reached under the foregoing clauses (i) and (ii), any shares of Class A Common Stock or other securities for the account of other persons that the Company is obligated to register pursuant to written contractual arrangements with such persons, as to which “piggy-back” registration has been requested by the holders thereof that can be sold without exceeding the Maximum Number of Shares.

2.2.5 Withdrawal. A Demanding Holder shall have the right to withdraw all or any portion of its Registrable Securities included in an Underwritten Demand Registration pursuant to this Section 2.2 for any reason or no reason whatsoever upon written notice to the Company and the Underwriter or Underwriters of its intention to withdraw from such Underwritten Demand Registration prior to the pricing of such Underwritten Demand Registration; provided, however, that such withdrawn amount shall still be considered an Underwritten Demand Registration. Notwithstanding anything to the contrary in this Agreement, the Company shall be responsible for the registration expenses incurred in connection with an Underwritten Demand Registration prior to its withdrawal under this Section 2.2.5.

2.3 Piggy-Back Registration.

2.3.1 Piggy-Back Rights. If the Company proposes to file a Registration Statement under the Securities Act with respect to an offering of equity securities, or securities or other obligations exercisable or exchangeable for, or convertible into, equity securities, by the Company for its own account or for shareholders of the Company for their account (or by the Company and by shareholders of the Company including, without limitation, pursuant to Section 2.2.1), other than a Registration Statement (i) filed in connection with any employee stock option, employee stock purchase, or other benefit plan, (ii) for an exchange offer or offering of securities solely to the Company’s existing shareholders, (iii) for an offering of debt that is convertible into equity securities of the Company, (iv) for a dividend reinvestment plan, (v) effected pursuant to Section 2.1 or 2.2 (which, for the avoidance of doubt, is addressed in and subject to the rights set forth therein), then the Company shall (x) give written notice of such

proposed filing to the holders of Registrable Securities with respect to shares not subject to any lock-up, as soon as practicable but in no event less than ten (10) days before the anticipated filing date, which notice shall describe the amount and type of securities to be included in such offering, the intended method(s) of distribution, and the name of the proposed managing Underwriter or Underwriters, if any, of the offering, and (y) offer to the holders of Registrable Securities in such notice the opportunity to register the sale of such number of shares of Registrable Securities as such holders may request in writing within five (5) Business Days following receipt of such notice (a “**Piggy-Back Registration**”). The foregoing rights shall not be available to any Investor at such time as (i) there is an effective Resale Shelf Registration Statement available for the resale of the Registrable Securities pursuant to Section 2.1 (which, for the avoidance of doubt, is addressed in and subject to the rights set forth in, Section 2.1 and 2.2 hereof) and there was no reduction in registered shares as set forth in Section 2.1.4 or (ii) such Registration is solely to be used for the offering of securities by the Company for its own account. The Company shall cause such Registrable Securities to be included in such registration, provided compliance by the Investors with Section 3.4, and the Company shall use its commercially reasonable efforts to cause the managing Underwriter or Underwriters of a proposed underwritten offering to permit the Registrable Securities requested to be included in a Piggy-Back Registration on the same terms and conditions as any similar securities of the Company and to permit the sale or other disposition of such Registrable Securities in accordance with the intended method(s) of distribution thereof. All holders of Registrable Securities proposing to distribute their securities through a Piggy-Back Registration that involves an Underwriter or Underwriters shall enter into an underwriting agreement in customary form with the Underwriter or Underwriters selected for such Piggy-Back Registration.

2.3.2 Reduction of Offering. If the managing Underwriter or Underwriters for a Piggy-Back Registration that is to be an underwritten offering advises the Company and the holders of Registrable Securities in writing that the dollar amount or number of shares of Class A Common Stock which the Company desires to sell, taken together with shares of Class A Common Stock, if any, as to which registration has been demanded pursuant to written contractual arrangements with persons other than the holders of Registrable Securities hereunder and the Registrable Securities as to which registration has been requested under this Section 2.3, exceeds the Maximum Number of Shares, then the Company shall include in any such registration:

(a) If the registration is undertaken for the Company’s account: (A) first, the shares of Class A Common Stock or other securities that the Company desires to sell that can be sold without exceeding the Maximum Number of Shares; and (B) second, to the extent that the Maximum Number of Shares has not been reached under the foregoing clause (A), the shares of Class A Common Stock or other securities, if any, comprised of Registrable Securities, as to which registration has been requested pursuant to the terms hereof, that can be sold without exceeding the Maximum Number of Shares, Pro Rata; and (C) third, to the extent that the Maximum Number of Shares has not been reached under the foregoing clauses (A) and (B), the shares of Class A Common Stock or other securities for the account of other persons that the Company is obligated to register pursuant to written contractual piggy-back registration rights with such persons and that can be sold without exceeding the Maximum Number of Shares; and

(b) If the registration is a “demand” registration undertaken at the demand of persons other than either the holders of Registrable Securities or the Company (other than as provided in Section 2.2 which, for the avoidance of doubt, is addressed in and subject to the rights set forth in, Section 2.2 hereof), (A) first, the shares of Class A Common Stock or other securities for the account of the demanding persons that can be sold without exceeding the Maximum Number of Shares; (B) second, to the extent that the Maximum Number of Shares has not been reached under the foregoing clause (A), the shares of Class A Common Stock or other securities that the Company desires to sell that can be sold without exceeding the Maximum Number of Shares; (C) third, to the extent that the Maximum Number of Shares has not been reached under the foregoing clauses (A) and (B), the shares of Class A Common Stock or other securities, if any, comprised of Registrable Securities, Pro Rata, as to which registration has been requested pursuant to the terms hereof, that can be sold without exceeding the Maximum Number of Shares; and (D) fourth, to the extent that the Maximum Number of Shares has not been reached under the foregoing clauses (A), (B) and (C), the shares of Class A Common Stock or other securities for the account of other persons that the Company is obligated to register pursuant to written contractual arrangements with such persons, that can be sold without exceeding the Maximum Number of Shares.

2.3.3 Withdrawal. Any holder of Registrable Securities may elect to withdraw such holder’s request for inclusion of Registrable Securities in any Piggy-Back Registration by giving written notice to the Company of such request to withdraw prior to the effectiveness of the Registration Statement, if such offering is pursuant to a Demand Registration, or prior to the public announcement of the offering, if such offering is pursuant to an Underwritten Takedown. The Company (whether on its own determination or as the result of a withdrawal by persons making a demand pursuant to written contractual obligations) may withdraw a Registration Statement at any time prior to the effectiveness of such Registration Statement. Notwithstanding any such withdrawal, the Company shall pay all expenses incurred by the holders of Registrable Securities in connection with such Piggy-Back Registration as provided in Section 3.3.

2.3.4 Unlimited Piggyback Registration Rights. For purposes of clarity, any Registration effected pursuant to Section 2.3 hereof shall not be counted as a Registration pursuant to a Demand registered effected under Section 2.2 hereof.

3. REGISTRATION PROCEDURES.

3.1 Filings; Information. Whenever the Company is required to effect the registration of any Registrable Securities pursuant to Section 2, the Company shall use its commercially reasonable efforts to effect the registration and sale of such Registrable Securities in accordance with the intended method(s) of distribution thereof as expeditiously as reasonably possible, and in connection with any such request:

3.1.1 Filing Registration Statement. The Company shall use its commercially reasonable efforts to, as expeditiously as possible after receipt of a request for a Demand Registration pursuant to Section 2.1, prepare and file with the Commission a Registration Statement on any form for which the Company then qualifies or which counsel for the Company

shall deem appropriate and which form shall be available for the sale of all Registrable Securities to be registered thereunder in accordance with the intended method(s) of distribution thereof, and shall use its commercially reasonable efforts to cause such Registration Statement to become effective and use its commercially reasonable efforts to keep it effective for the Effectiveness Period (as defined below); provided, however, that the Company shall have the right to defer any Demand Registration for up to forty-five (45) days, and any Piggy-Back Registration for such period as may be applicable to deferment of any Demand Registration to which such Piggy-Back Registration relates, in each case if the Company shall furnish to the holders a certificate signed by the Company stating that, in the good faith judgment of the Board of Directors of the Company (the “**Company Board**”), it would require the Company to make an Adverse Disclosure; provided, further, however, that the Company shall not have the right to exercise the right set forth in the immediately preceding proviso twice, or for more than sixty (60) total calendar days in any 360-day period.

3.1.2 Copies. The Company shall, prior to filing a Registration Statement or prospectus, or any amendment or supplement thereto, furnish without charge to the holders of Registrable Securities included in such registration, and such holders’ legal counsel, copies of such Registration Statement as proposed to be filed, each amendment and supplement to such Registration Statement (in each case, including all exhibits thereto and documents incorporated by reference therein), the prospectus included in such Registration Statement (including each preliminary prospectus), and such other documents as the holders of Registrable Securities included in such registration or legal counsel for any such holders may request in order to facilitate the disposition of the Registrable Securities owned by such holders.

3.1.3 Amendments and Supplements. The Company shall prepare and file with the Commission such amendments, including post-effective amendments, and supplements to such Registration Statement and the prospectus used in connection therewith as may be necessary to keep such Registration Statement effective and in compliance with the provisions of the Securities Act until the date on which all Registrable Securities and other securities covered by such Registration Statement have been disposed of in accordance with the intended method(s) of distribution set forth in such Registration Statement or such securities have been withdrawn (the “**Effectiveness Period**”).

3.1.4 Notification. After the filing of a Registration Statement, the Company shall promptly, and in no event more than two (2) Business Days after such filing, notify the holders of Registrable Securities included in such Registration Statement of such filing, and shall further notify such holders promptly and confirm such advice in writing in all events within two (2) Business Days of the occurrence of any of the following: (i) when such Registration Statement becomes effective; (ii) when any post-effective amendment to such Registration Statement becomes effective; (iii) the issuance or threatened issuance by the Commission of any stop order (and the Company shall take all actions required to prevent the entry of such stop order or to remove it if entered); and (iv) any request by the Commission for any amendment or supplement to such Registration Statement or any prospectus relating thereto or for additional information or of the occurrence of an event requiring the preparation of a supplement or amendment to such prospectus so that, as thereafter delivered to the purchasers of the securities covered by such Registration Statement, such prospectus will not contain an untrue statement of

a material fact or omit to state any material fact required to be stated therein or necessary to make the statements therein not misleading, and promptly make available to the holders of Registrable Securities included in such Registration Statement any such supplement or amendment; except that before filing with the Commission a Registration Statement or prospectus or any amendment or supplement thereto, including documents incorporated by reference, the Company shall furnish to the holders of Registrable Securities included in such Registration Statement and to the legal counsel for any such holders, copies of all such documents proposed to be filed sufficiently in advance of filing to provide such holders and legal counsel with a reasonable opportunity to review such documents and comment thereon.

3.1.5 Securities Laws Compliance. The Company shall use its commercially reasonable efforts to (i) register or qualify the Registrable Securities covered by the Registration Statement under such securities or “blue sky” laws of such jurisdictions in the United States as the holders of Registrable Securities included in such Registration Statement (in light of their intended plan of distribution) may reasonably request and (ii) take such action necessary to cause such Registrable Securities covered by the Registration Statement to be registered with or approved by such other governmental authorities as may be necessary by virtue of the business and operations of the Company and do any and all other acts and things that may be necessary or advisable to enable the holders of Registrable Securities included in such Registration Statement to consummate the disposition of such Registrable Securities in such jurisdictions; provided, however, that the Company shall not be required to qualify generally to do business in any jurisdiction where it would not otherwise be required to qualify but for this paragraph or subject itself to taxation in any such jurisdiction.

3.1.6 Agreements for Disposition. The Company shall enter into customary agreements (including, if applicable, an underwriting agreement in customary form) and take such other actions as are reasonably required in order to expedite or facilitate the disposition of such Registrable Securities. The representations, warranties and covenants of the Company in any underwriting agreement which are made to or for the benefit of any Underwriters, to the extent applicable, shall also be made to and for the benefit of the holders of Registrable Securities included in such registration statement, and the representations, warranties and covenants of the holders of Registrable Securities included in such registration statement in any underwriting agreement which are made to or for the benefit of any Underwriters, to the extent applicable, shall also be made to and for the benefit of the Company.

3.1.7 Comfort Letter. In the event of an Underwritten Takedown or an Underwritten Demand Registration, the Company shall obtain a “cold comfort” letter from the Company’s independent registered public accountants in the event of an underwritten offering, and a customary “bring-down” thereof, in customary form and covering such matters of the type customarily covered by “cold comfort” letters, as the managing Underwriter may reasonably request, and reasonably satisfactory to a majority-in-interest of the participating holders. For the avoidance of doubt, this Section 3.1.7 shall not apply to any Block Trade.

3.1.8 Opinions and Negative Assurance Letters. In the event of an Underwritten Takedown or an Underwritten Demand Registration, on the date the Registrable Securities are delivered for sale pursuant to any Registration, the Company shall obtain an opinion and negative assurances letter, each dated such date, of one (1) counsel representing the Company for the purposes of such Registration, including an opinion of local counsel if applicable, addressed to the holders, the placement agent or sales agent, if any, and the Underwriters, if any, covering such legal matters with respect to such Registration in respect of which such opinion is being given as the holders, placement agent, sales agent, or Underwriter may reasonably request and as are customarily included in such opinions, and reasonably satisfactory to a majority in interest of the participating holders. For the avoidance of doubt, this Section 3.1.8 shall not apply to any Block Trade.

3.1.9 Cooperation. The principal executive officer of the Company, the principal financial officer of the Company, the principal accounting officer of the Company and all other officers and members of the management of the Company shall cooperate fully in any offering of Registrable Securities hereunder, which cooperation shall include, without limitation, the preparation of the Registration Statement with respect to such offering, the preparation of a comfort letter, if applicable, and all other offering materials and related documents, and participation in meetings with Underwriters, attorneys, accountants and potential investors.

3.1.10 Transfer Agent. The Company shall provide and maintain a transfer agent and registrar for the Registrable Securities.

3.1.11 Records. Upon execution of confidentiality agreements, the Company shall make available for inspection by the holders of Registrable Securities included in such Registration Statement, any Underwriter participating in any disposition pursuant to such registration statement and any attorney, accountant or other professional retained by any holder of Registrable Securities included in such Registration Statement or any Underwriter, all financial and other records, pertinent corporate documents and properties of the Company, as shall be necessary to enable them to exercise their due diligence responsibility, and cause the Company's officers, directors and employees to supply all information requested by any of them in connection with such Registration Statement.

3.1.12 Earnings Statement. The Company shall comply with all applicable rules and regulations of the Commission and the Securities Act, and make available to its shareholders, as soon as practicable, an earnings statement covering a period of twelve (12) months, which earnings statement shall satisfy the provisions of Section 11(a) of the Securities Act and Rule 158 thereunder.

3.1.13 Road Show. If an offering pursuant to this Agreement is conducted as an Underwritten Takedown or Underwritten Demand Registration and involves Registrable Securities with an aggregate offering price (before deduction of underwriting discounts) is expected to exceed \$10,000,000, the Company shall use its reasonable best efforts to make available senior executives of the Company to participate in customary "road show" presentations that may be reasonably requested by the Underwriter in such offering.

3.1.14 Listing. The Company shall use its commercially reasonable efforts to cause all Registrable Securities included in any Registration Statement to be listed on such exchanges or otherwise designated for trading in the same manner as similar securities issued by the Company are then listed or designated.

3.2 Obligation to Suspend Distribution. Upon receipt of any notice from the Company of the happening of any event of the kind described in Section 3.1.4(iv), or, upon any suspension by the Company, pursuant to a good faith reasonable determination of the board of directors of the Company that the offer or sale of Registrable Securities would require the Company to disclose Adverse Disclosure, each holder of Registrable Securities included in any registration shall immediately discontinue disposition of such Registrable Securities pursuant to the Registration Statement covering such Registrable Securities until such holder receives the supplemented or amended prospectus contemplated by Section 3.1.4(iv) or the restriction on the ability of “insiders” to transact in the Company’s securities is removed, as applicable, and, if so directed by the Company, each such holder will deliver to the Company or destroy all copies, other than permanent file copies then in such holder’s possession, of the most recent prospectus covering such Registrable Securities at the time of receipt of such notice. The foregoing right to delay or suspend may be exercised by the Company for no longer than sixty (60) days in any consecutive 12-month period.

3.3 Registration Expenses. The Company shall bear all costs and expenses incurred in connection with the Resale Shelf Registration Statement pursuant to Section 2.1, any Demand Registration pursuant to Section 2.2.1, any Underwritten Takedown pursuant to Section 2.1.6, any Block Trade pursuant to Section 2.1.7 (other than expenses set forth below in clause (ix) of this Section 3.3), any Piggy-Back Registration pursuant to Section 2.3, and all expenses incurred in performing or complying with its other obligations under this Agreement, whether or not the Registration Statement becomes effective, including, without limitation: (i) all registration and filing fees; (ii) fees and expenses of compliance with securities or “blue sky” laws (including fees and disbursements of counsel in connection with blue sky qualifications of the Registrable Securities); (iii) printing expenses; (iv) the Company’s internal expenses (including, without limitation, all salaries and expenses of its officers and employees); (v) the fees and expenses incurred in connection with the listing of the Registrable Securities as required by Section 3.1.12; (vi) Financial Industry Regulatory Authority fees; (vii) fees and disbursements of counsel for the Company and fees and expenses for independent certified public accountants retained by the Company; (viii) the fees and expenses of any special experts retained by the Company in connection with such registration; and (ix) the reasonable fees and expenses of one legal counsel selected by the holders of a majority-in-interest of the Registrable Securities included in such registration. The Company shall have no obligation to pay any underwriting discounts or selling commissions attributable to the Registrable Securities being sold by the holders thereof, which underwriting discounts or selling commissions shall be borne by such holders, but the Company shall pay any underwriting discounts or selling commissions attributable to the securities it sells for its own account.

3.4 Information. The holders of Registrable Securities shall promptly provide such information as may reasonably be requested by the Company, or the managing Underwriter, if any, in connection with the preparation of any Registration Statement, including amendments and supplements thereto, in order to effect the registration of any Registrable Securities under the Securities Act and in connection with the Company’s obligation to comply with Federal and applicable state securities laws.

3.5 Other Obligations.

3.5.1 At any time and from time to time after the expiration of any lock-up to which such shares are subject, if any, in connection with a sale or transfer of Registrable Securities exempt from registration under the Securities Act or through any broker-dealer transactions described in the plan of distribution set forth within any prospectus and pursuant to the Registration Statement of which such prospectus forms a part, the Company shall, subject to the receipt of customary documentation required from the applicable holders in connection therewith, (i) promptly instruct its transfer agent to remove any restrictive legends applicable to the Registrable Securities being sold or transferred and (ii) cause its legal counsel to deliver the necessary legal opinions, if any, to the transfer agent in connection with the instruction under subclause (i). In addition, the Company shall cooperate reasonably with, and take such customary actions as may reasonably be requested by such holders in connection with the aforementioned sales or transfers.

3.5.2 The stock certificates evidencing the Registrable Securities (and/or book entries representing the Registrable Securities) held by each Investor shall not contain or be subject to any legend restricting the transfer thereof (and the Registrable Securities shall not be subject to any stop transfer or similar instructions or notations): (A) while a Registration Statement covering the sale or resale of such securities is effective under the Securities Act, or (B) if such Investor provides customary paperwork to the effect that it has sold such shares pursuant to Rule 144, or (C) if such Registrable Securities are eligible for sale under Rule 144(b)(1) as set forth in customary non-affiliate paperwork provided by such Investor, or (D) if at any time on or after the date that is one year after the Form 10 Disclosure Filing Date such Investor certifies that it is not an affiliate of the Company and that such Investor's holding period for purposes of Rule 144 in respect of such Registrable Securities is at least six (6) months, or (E) if such legend is not required under applicable requirements of the Securities Act (including judicial interpretations and pronouncements issued by the staff of the Commission) as determined in good faith by counsel to the Company or set forth in a legal opinion delivered by nationally recognized counsel to the Investor (collectively, the "**Unrestricted Conditions**"). The Company agrees that following the date that the Resale Shelf Registration Statement has been declared effective by the Commission or at such time as any of the Unrestricted Conditions is met or such legend is otherwise no longer required it will, no later than two (2) Business Days following the delivery by an Investor to the Company or its transfer agent of a certificate representing any Registrable Securities, issued with a restrictive legend, (or, in the case of Registrable Securities represented by book entries, delivery by an Investor to the Company or its transfer agent of a legend removal request) deliver or cause to be delivered to such Investor a certificate or, at the request of such Investor, deliver or cause to be delivered such Registrable Securities to such Investor by crediting the account of such Investor's prime broker with DTC through its Deposit/Withdrawal at Custodian (DWAC) system, in each case, free from all restrictive and other legends and stop transfer or similar instructions or notations. If any of the Unrestricted Conditions is met at the time of issuance of any Registrable Securities (e.g., upon exercise of warrants), then such securities shall be issued free of all legends. Each Investor shall have the right to pursue any remedies available to it hereunder, or otherwise at law or in equity, including a decree of specific performance and/or injunctive relief, with respect to the Company's failure to timely deliver shares of Class A Common Stock without legend as required pursuant to the terms hereof.

3.5.3 As long as Registrable Securities remain outstanding the Company shall (a) cause the Class A Common Stock to be eligible for clearing through DTC, through its DWAC system; (b) be eligible and participating in the Direct Registration System (DRS) of DTC with respect to the Class A Common Stock; (c) ensure that the transfer agent for the Class A Common Stock is a participant in, and that the Class A Common Stock is eligible for transfer pursuant to, DTC's Fast Automated Securities Transfer Program (or successor thereto); and (d) use its reasonable best efforts to cause the Class A Common Stock to not at any time be subject to any DTC "chill," "freeze" or similar restriction with respect to any DTC services, including the clearing of shares of Common Stock through DTC, and, in the event the Class A Common Stock becomes subject to any DTC "chill," "freeze" or similar restriction with respect to any DTC services, use its reasonable best efforts to cause any such "chill," "freeze" or similar restriction to be removed at the earliest possible time.

4. INDEMNIFICATION AND CONTRIBUTION.

4.1 Indemnification by the Company. The Company agrees to indemnify and hold harmless, to the fullest extent permitted by law, each Investor and each other holder of Registrable Securities, and each of their respective officers, employees, affiliates, directors, partners, members, attorneys and agents, and each person, if any, who controls an Investor and each other holder of Registrable Securities (within the meaning of Section 15 of the Securities Act or Section 20 of the Exchange Act) (each, an "**Investor Indemnified Party**"), from and against any expenses, losses, judgments, claims, damages or liabilities, whether joint or several, (including reasonable and documented costs of investigation and legal expenses and any indemnity and contribution payments made to underwriters) arising out of or based upon any untrue statement (or allegedly untrue statement) of a material fact contained in any Registration Statement under which the sale of such Registrable Securities was registered under the Securities Act, any preliminary prospectus, final prospectus or summary prospectus contained in the Registration Statement, or any amendment or supplement to such Registration Statement, or arising out of or based upon any omission (or alleged omission) to state a material fact required to be stated therein or necessary to make the statements therein not misleading, or any violation by the Company of the Securities Act or any rule or regulation promulgated thereunder applicable to the Company and relating to action or inaction required of the Company in connection with any such registration; and the Company shall promptly reimburse the Investor Indemnified Party for any legal and any other expenses reasonably incurred by such Investor Indemnified Party in connection with investigating and defending any such expense, loss, judgment, claim, damage, liability or action; *provided, however*, that the Company will not be liable in any such case to the extent that any such expense, loss, claim, damage or liability is finally judicially determined to have arisen out of or resulted from any untrue statement or allegedly untrue statement or omission or alleged omission made in such Registration Statement, preliminary prospectus, final prospectus, or summary prospectus, or any such amendment or supplement, in reliance upon and in conformity with information furnished to the Company, in writing, by such selling holder expressly for use therein or to the extent related to any selling holder's violation of the federal securities laws (including Regulation M) or failure to sell the Registrable Securities in accordance with the plan of distribution contained in the prospectus.

4.2 Indemnification by Holders of Registrable Securities. Each selling holder of Registrable Securities will, in the event that any Registration is being effected under the Securities Act pursuant to this Agreement of any Registrable Securities held by such selling holder, indemnify and hold harmless to the fullest extent permitted by law the Company, each of its directors and officers, and each other selling holder of Registrable Securities and each other person, if any, who controls such other selling holder within the meaning of the Securities Act, against any losses, claims, judgments, damages or liabilities, only insofar as such losses, claims, judgments, damages or liabilities (or actions in respect thereof) arise out of or are based upon (i) any untrue statement or allegedly untrue statement of a material fact contained in any Registration Statement under which the sale of such Registrable Securities was registered under the Securities Act, any preliminary prospectus, final prospectus or summary prospectus contained in the Registration Statement, or any amendment or supplement to the Registration Statement, or arise out of or are based upon any omission or the alleged omission to state a material fact required to be stated therein or necessary to make the statement therein not misleading, if the statement or omission was made expressly in reliance upon and in conformity with information furnished in writing to the Company by such selling holder in writing expressly for use therein, or (ii) such selling holder's failure to sell the Registrable Securities in accordance with the plan of distribution contained in the prospectus, and shall reimburse the Company, its directors and officers, and each other selling holder or controlling person for any legal or other expenses reasonably incurred by any of them in connection with investigation or defending any such loss, claim, damage, liability or action. Each selling holder's indemnification obligations hereunder shall be several and not joint and shall be limited to the amount of any net proceeds actually received by such selling holder upon the sale of Registrable Securities giving rise to such indemnification obligations.

4.3 Conduct of Indemnification Proceedings. Promptly after receipt by any person of any notice of any loss, claim, damage or liability or any action in respect of which indemnity may be sought pursuant to Sections 4.1 or 4.2, such person (the "**Indemnified Party**") shall, if a claim in respect thereof is to be made against any other person for indemnification hereunder, notify such other person (the "**Indemnifying Party**") in writing of the loss, claim, judgment, damage, liability or action; provided, however, that the failure by the Indemnified Party to notify the Indemnifying Party shall not relieve the Indemnifying Party from any liability which the Indemnifying Party may have to such Indemnified Party hereunder, except and solely to the extent the Indemnifying Party is actually prejudiced by such failure. If the Indemnified Party is seeking indemnification with respect to any claim or action brought against the Indemnified Party, then the Indemnifying Party shall be entitled to participate in such claim or action, and, to the extent that it wishes, jointly with all other Indemnifying Parties, to assume control of the defense thereof with counsel satisfactory to the Indemnified Party. After notice from the Indemnifying Party to the Indemnified Party of its election to assume control of the defense of such claim or action, the Indemnifying Party shall not be liable to the Indemnified Party for any legal or other expenses subsequently incurred by the Indemnified Party in connection with the defense thereof other than reasonable costs of investigation; provided, however, that in any

action in which both the Indemnified Party and the Indemnifying Party are named as defendants, the Indemnified Party shall have the right to employ separate counsel (but no more than one such separate counsel, which counsel is reasonably acceptable to the Indemnifying Party) to represent the Indemnified Party and its controlling persons who may be subject to liability arising out of any claim in respect of which indemnity may be sought by the Indemnified Party against the Indemnifying Party, with the fees and expenses of such counsel to be paid by such Indemnifying Party if, based upon the written opinion of counsel of such Indemnified Party, representation of both parties by the same counsel would be inappropriate due to actual or potential differing interests between them. No Indemnifying Party shall, without the prior written consent of the Indemnified Party, consent to entry of judgment or effect any settlement of any claim or pending or threatened proceeding in respect of which the Indemnified Party is or could have been a party and indemnity could have been sought hereunder by such Indemnified Party, unless such judgment or settlement includes an unconditional release of such Indemnified Party from all liability arising out of such claim or proceeding.

4.4 Contribution.

4.4.1 If the indemnification provided for in the foregoing Sections 4.1, 4.2 and 4.3 is unavailable to any Indemnified Party in respect of any loss, claim, damage, liability or action referred to herein, then each such Indemnifying Party, in lieu of indemnifying such Indemnified Party, shall contribute to the amount paid or payable by such Indemnified Party as a result of such loss, claim, damage, liability or action in such proportion as is appropriate to reflect the relative fault of the Indemnified Parties and the Indemnifying Parties in connection with the actions or omissions which resulted in such loss, claim, damage, liability or action, as well as any other relevant equitable considerations. The relative fault of any Indemnified Party and any Indemnifying Party shall be determined by reference to, among other things, whether the untrue or alleged untrue statement of a material fact or the omission or alleged omission to state a material fact relates to information supplied by such Indemnified Party or such Indemnifying Party and the parties' relative intent, knowledge, access to information and opportunity to correct or prevent such statement or omission.

4.4.2 The parties hereto agree that it would not be just and equitable if contribution pursuant to this Section 4.4 were determined by pro rata allocation or by any other method of allocation which does not take account of the equitable considerations referred to in Section 4.4.1.

4.4.3 The amount paid or payable by an Indemnified Party as a result of any loss, claim, damage, liability or action referred to in the immediately preceding paragraph shall be deemed to include, subject to the limitations set forth above, any legal or other expenses incurred by such Indemnified Party in connection with investigating or defending any such action or claim. Notwithstanding the provisions of this Section 4.4, no holder of Registrable Securities shall be required to contribute any amount in excess of the dollar amount of the net proceeds (after payment of any underwriting fees, discounts, commissions or taxes) actually received by such holder from the sale of Registrable Securities which gave rise to such contribution obligation. No person guilty of fraudulent misrepresentation (within the meaning of Section 11(f) of the Securities Act) shall be entitled to contribution from any person who was not guilty of such fraudulent misrepresentation.

5. UNDERWRITING AND DISTRIBUTION.

5.1 Rule 144. The Company covenants that it shall timely file any reports required to be filed by it under the Securities Act and the Exchange Act and shall take such further action as the holders of Registrable Securities may reasonably request, all to the extent required from time to time to enable such holders to sell Registrable Securities without registration under the Securities Act within the limitation of the exemptions provided by Rule 144 under the Securities Act, as such Rules may be amended from time to time, or any similar rule or regulation hereafter adopted by the Commission. Upon reasonable prior written request, the Company shall deliver to the Investors a customary written statement as to whether it has complied with such requirements.

6. LOCK-UP AGREEMENTS.

6.1 Investor Lock-Up. Without limiting the terms of any other Ancillary Document or any other contract, agreement or understanding entered into by any Investor, each Investor agrees that it shall not Transfer any shares of Class A Common Stock or any securities convertible into or exercisable or exchangeable (directly or indirectly) for shares of Class A Common Stock (including New Securities) until the Lock-Up Release Date; *provided, however*, that the foregoing restrictions shall (i) not apply to any shares of Class A Common Stock purchased by an Investor in the PIPE Financing and (ii) with respect to the Non-Redemption Investors, only apply to shares of Class A Common Stock received by the Non-Redemption Investors pursuant to the Non-Redemption Agreements. The foregoing restriction is expressly agreed to preclude each Investor from engaging in any hedging or other transaction which is designed to or which reasonably could be expected to lead to or result in a sale or disposition of such Investor's shares of Class A Common Stock even if such shares of Class A Common Stock would be disposed of by someone other than the undersigned until the Lock-Up Release Date. Such prohibited hedging or other transactions would include without limitation any short sale or any purchase, sale or grant of any right (including, without limitation, any put or call option) with respect to any of the Investor's shares of Class A Common Stock or with respect to any security that includes, relates to, or derives any significant part of its value from such shares of Class A Common Stock. The foregoing restrictions shall not apply to Transfers made: (i) pursuant to a *bona fide* gift or charitable contribution; (ii) by will or intestate succession upon the death of an Investor; (iii) to any Permitted Transferee; (iv) pursuant to a court order or settlement agreement related to the distribution of assets in connection with the dissolution of marriage or civil union; or (v) in the case of any Investor that is not a natural person, pro rata to the direct or indirect partners, members or shareholders of an Investor or any related investment funds or vehicles controlled or managed by such persons or their respective affiliates in connection with the liquidation or dissolution thereof; or (vi) in the event of the Company's completion of a liquidation, merger, share exchange or other similar transaction which results in all of its shareholders having the right to exchange their shares of Class A Common Stock for cash, securities or other property; provided that in the case of (i) through (vi), the recipient of such Transfer must enter into a written agreement agreeing to be bound by the terms of this Agreement in form and substance reasonably satisfactory to the Company, including the transfer restrictions set forth in this Section 6.1.

The foregoing notwithstanding, to the extent any Investor is granted a release or waiver from the restrictions contained in this Section 6 prior to the expiration of the Lock-Up Release Date, then all Investors shall be automatically granted a release or waiver from the restrictions contained in this Section 6 to the same extent, on substantially the same terms as and on a pro rata basis with, the Investor to which such release or waiver is granted.

7. RESERVED.

8. MISCELLANEOUS.

8.1 Other Registration Rights and Arrangements. The Company represents and warrants that no person, other than a holder of the Registrable Securities and the investors of the PIPE Financing has any right to require the Company to register any of the Company's capital stock for sale or to include the Company's capital stock in any registration filed by the Company for the sale of capital stock for its own account or for the account of any other person. The parties hereby terminate the Prior Agreements, each of which shall be of no further force and effect and is hereby superseded and replaced in its entirety by this Agreement. The Company shall not hereafter enter into any agreement with respect to its securities which is inconsistent with or violates the rights granted to the holders of Registrable Securities in this Agreement and in the event of any conflict between any such agreement or agreements and this Agreement, the terms of this Agreement shall prevail.

8.2 Assignment; No Third-Party Beneficiaries. This Agreement and the rights, duties and obligations of the Company hereunder may not be assigned or delegated by the Company in whole or in part. This Agreement and the rights, duties and obligations of the holders of Registrable Securities hereunder may be freely assigned or delegated by such holder of Registrable Securities in conjunction with and to the extent of any permitted transfer of Registrable Securities by any such holder to a Permitted Transferee. This Agreement and the provisions hereof shall be binding upon and shall inure to the benefit of each of the parties hereto and their respective successors and assigns and the holders of Registrable Securities and their respective successors and permitted assigns. This Agreement is not intended to confer any rights or benefits on any persons that are not party hereto other than as expressly set forth in Section 4 and this Section 8.2. The rights of a holder of Registrable Securities under this Agreement may be transferred by such a holder to a transferee who acquires or holds Registrable Securities; provided, however, that such transferee has executed and delivered to the Company a properly completed agreement to be bound by the terms of this Agreement substantially in form attached hereto as Exhibit A (an "**Addendum Agreement**"), and the transferor shall have delivered to the Company no later than fifteen (15) days following the date of the transfer, written notification of such transfer setting forth the name of the transferor, the name and address of the transferee, and the number of Registrable Securities so transferred. The execution of an Addendum Agreement shall constitute a permitted amendment of this Agreement.

8.3 Amendments and Modifications. Upon the written consent of the Company and the Investors of at least a majority in interest of the Registrable Securities at the time in question, compliance with any of the provisions, covenants and conditions set forth in this Agreement may be waived, or any of such provisions, covenants or conditions may be amended or modified; provided, however, that notwithstanding the foregoing, any amendment hereto or waiver hereof that adversely affects an Investor, solely in his, her or its capacity as a holder of the shares of capital stock of the Company, in a manner that is materially different from other Investors (in such capacity) shall require the consent of such Investor so affected; provided, further, however, that any waiver, amendment or repeal of the restrictions set forth in Section 6.1 (or of this Section 8.3 in respect of this proviso) shall require the prior written consent of the Sponsor. No course of dealing between any Investor or the Company and any other party hereto or any failure or delay on the part of an Investor or the Company in exercising any rights or remedies under this Agreement shall operate as a waiver of any rights or remedies of any Investor or the Company. No single or partial exercise of any rights or remedies under this Agreement by a party shall operate as a waiver or preclude the exercise of any other rights or remedies hereunder or thereunder by such party.

8.4 Term. This Agreement shall terminate upon the earlier of (i) the tenth anniversary of the date of this Agreement or (ii) the date as of which there shall be no Registrable Securities outstanding; provided further that with respect to any Investor, such Investor will have no rights under this Agreement and all obligations of the Company to such Investor under this Agreement shall terminate upon the earlier of (x) the date at least one year after the date hereof that such Investor ceases to hold at least 1 % of the Registrable Securities outstanding on the date hereof or (y) if such Investor is a director or an executive officer of the Company, the date such Investor no longer serves as a director or an executive officer of the Company; provided, however, that such termination as to an Investors shall not apply to the following provisions until such Investor no longer holds any Registrable Securities: Sections 3.1.4, 3.1.5, 3.1.10, 3.1.12, 3.1.14, 3.2, 3.3, 3.4, 3.5, 7.3, 8.3, 8.5 and Articles IV and V. Notwithstanding the foregoing, the piggy-back registration rights provided for in Section 2.3 of this Agreement shall terminate no later than the third anniversary of the date of this Agreement.

8.5 Notices. All notices, demands, requests, consents, approvals or other communications (collectively, “**Notices**”) required or permitted to be given hereunder or which are given with respect to this Agreement shall be in writing and shall be personally served, delivered by reputable air courier service with charges prepaid, or transmitted by facsimile or email, addressed as set forth below, or to such other address as such party shall have specified most recently by written notice. Notice shall be deemed given (i) on the date of service or transmission if personally served or transmitted by email, or facsimile; provided, that if such service or transmission is not on a Business Day or is after normal business hours, then such notice shall be deemed given on the next Business Day or (ii) one Business Day after being deposited with a reputable courier service with an order for next-day delivery, to the parties as follows:

If to the Company:

Senti Biosciences, Inc.
2 Corporate Drive, 1st Floor
South San Francisco, CA 94080
Attn: Timothy Lu
Email: tim.lu@senti.bio.com

with a copy to:

Goodwin Procter LLP
100 Northern Avenue
Boston, MA 02210
Attn: Jocelyn Arel
Michael Patrone
Email: jarel@goodwinlaw.com
MPatrone@goodwinprocter.com

If to DYNS:

2875 El Camino Real
Redwood City, CA 94061
Attn: Mostafa Ronaghi, Chief Executive Officer
Email:

with a copy to:

Davis Polk & Wardwell LLP
450 Lexington Avenue
New York, NY 10017
Attn: Alan Denenberg
Oliver Smith
Email: alan.denenberg@davispolk.com
oliver.smith@davispolk.com

If to an Investor, to the address set forth under such Investor's signature to this Agreement or to such Investor's address as found in the Company's books and records.

8.6 Severability. This Agreement shall be deemed severable, and the invalidity or unenforceability of any term or provision hereof shall not affect the validity or enforceability of this Agreement or of any other term or provision hereof. Furthermore, in lieu of any such invalid or unenforceable term or provision, the parties hereto intend that there shall be added as a part of this Agreement a provision as similar in terms to such invalid or unenforceable provision as may be possible that is valid and enforceable.

8.7 Counterparts. This Agreement may be executed in multiple counterparts, each of which shall be deemed an original, and all of which taken together shall constitute one and the same instrument.

8.8 Entire Agreement. This Agreement (including all agreements entered into pursuant hereto and all certificates and instruments delivered pursuant hereto and thereto) constitute the entire agreement of the parties with respect to the subject matter hereof and supersede all prior and contemporaneous agreements, representations, understandings, negotiations and discussions between the parties, whether oral or written, including, without limitation the Prior Agreement.

[Signature Page Follows]

IN WITNESS WHEREOF, the parties have caused this Investor Rights and Lock-Up Agreement to be executed and delivered by their duly authorized representatives as of the date first written above.

DYNAMICS SPECIAL PURPOSE CORP.

By: _____
Name: Mostafa Ronaghi
Title: Chief Executive Officer

SIGNATURE PAGE TO INVESTOR RIGHTS AGREEMENT

IN WITNESS WHEREOF, the parties have caused this Investor Rights and Lock Up Agreement to be executed and delivered by their duly authorized representatives as of the date first written above.

INVESTORS:

SIGNATURE PAGE TO INVESTOR RIGHTS AGREEMENT

EXHIBIT A

Addendum Agreement

This Addendum Agreement (“**Addendum Agreement**”) is executed on _____, 20____, by the undersigned (the “**New Holder**”) pursuant to the terms of that certain Investor Rights and Lock-Up Agreement dated as of [•], 2021 (the “**Agreement**”), by and among the Company and the Investors identified therein, as such Agreement may be amended, supplemented or otherwise modified from time to time. Capitalized terms used but not defined in this Addendum Agreement shall have the respective meanings ascribed to such terms in the Agreement. By the execution of this Addendum Agreement, the New Holder agrees as follows:

1. Acknowledgment. New Holder acknowledges that New Holder is acquiring certain shares of common stock of the Company (the “**Class A Common Stock**”) as a transferee of such shares of Class A Common Stock from a party in such party’s capacity as a holder of Registrable Securities under the Agreement, and after such transfer, New Holder shall be considered an “Investor” and a holder of Registrable Securities for all purposes under the Agreement.

2. Agreement. New Holder hereby (a) agrees that the shares of Class A Common Stock shall be bound by and subject to the terms of the Agreement and (b) adopts the Agreement with the same force and effect as if the New Holder were originally a party thereto.

3. Notice. Any notice required or permitted by the Agreement shall be given to New Holder at the address or facsimile number listed below New Holder’s signature below.

NEW HOLDER:

Print Name: _____

By: _____

ACCEPTED AND AGREED:

DYNAMICS SPECIAL PURPOSE CORP.

By: _____

Name: Mostafa Ronaghi

Title: Chief Executive Officer

SCHEDULE I

DYNS Investors

DYNSSponsor LLC

[•]

Senti Investors

[•]

SCHEDULE II
Investors by Lock-Up

1 year lockup

18 month lockup

SPONSOR SUPPORT AGREEMENT

This **SPONSOR SUPPORT AGREEMENT** (this "**Agreement**"), dated as of December 19, 2021, is made by and among Dynamics Sponsor LLC, a Delaware limited liability company (the "**Sponsor**") as the sole holder of Class B common stock par value \$0.0001 per share (the "**Class B Common Stock**") of Dynamics Special Purpose Corp., solely for purposes of Section 5 of this Agreement, the other Persons party hereto as "Other DYNs Insiders" set forth on the signature pages hereto (the "**Other DYNs Insiders**"), and together with the Sponsor, collectively, the "**DYNs Insiders**", Dynamics Special Purpose Corp., a Delaware corporation ("**DYNS**"), and Senti Biosciences, Inc., a Delaware corporation (the "**Company**"). The Sponsor, DYNS and the Company shall be referred to herein from time to time collectively as the "**Parties**". Capitalized terms used but not otherwise defined herein shall have the meanings ascribed to such terms in the Business Combination Agreement (as defined below).

WHEREAS, DYNS, the Company and Explore Merger Sub, Inc., a Delaware corporation ("**Merger Sub**"), entered into that certain Business Combination Agreement, dated as of the date hereof (as it may be amended, restated or otherwise modified from time to time in accordance with its terms, the "**Business Combination Agreement**");

WHEREAS, as of the date of this Agreement, the Sponsor owns 5,750,000 shares of Class B Common Stock; and

WHEREAS, the Business Combination Agreement contemplates that the Parties will enter into this Agreement concurrently with the entry into the Business Combination Agreement by the parties thereto, pursuant to which, among other things, the Sponsor will vote in favor of approval of the Business Combination Agreement and the transactions contemplated thereby (including the Merger).

NOW, THEREFORE, in consideration of the premises and the mutual promises contained herein and for other good and valuable consideration, the receipt and sufficiency of which are hereby acknowledged, the Parties, each intending to be legally bound, hereby agree as follows:

1. *Agreement to Vote.*

(a) Pursuant to Section 3 of that certain Letter Agreement, dated as of May 25, 2021 (the "**Insider Letter**"), by and among DYNS and the DYNs Insiders, the Sponsor hereby consents to the entry by DYNS into the Business Combination Agreement and each other Ancillary Document to which DYNS is or will be a party.

(b) For so long as this Agreement is in effect, the Sponsor hereby agrees to vote at any meeting of the stockholders of DYNS, and in any action by written resolution of the stockholders of DYNS, all of the Sponsor's shares of Class B Common Stock (together with any other Equity Securities of DYNS that the Sponsor holds of record or beneficially, as of the date of this Agreement, or of which the Sponsor acquires record or beneficial ownership after the date hereof, collectively, the "**Subject DYNS Equity Securities**") in favor of the Required Transaction Proposals, and against any proposal

that conflicts or materially impedes or interferes with any Required Transaction Proposals, including any DYNS Acquisition Proposal, or that would adversely affect or delay the consummation of the transactions contemplated by the Business Combination Agreement. The Sponsor shall validly execute and deliver to DYNS, on (or effective as of) the fifth (5th) Business Day following the date that the Proxy Statement/Prospectus is disseminated by DYNS to DYNS's stockholders (following the date that the Registration Statement/Proxy Statement becomes effective), a properly completed voting proxy in the form distributed by or on behalf of DYNS in favor of the Required Transaction Proposals. In the event of any equity dividend or distribution, or any change in the equity interests of DYNS by reason of any equity dividend or distribution, equity split, recapitalization, combination, conversion, exchange of equity interests or the like prior to the Closing, the term "Subject DYNS Equity Securities" shall be deemed to refer to and include the Subject DYNS Equity Securities as well as all such equity dividends and distributions and any securities into which or for which any or all of the Subject DYNS Equity Securities may be changed or exchanged or which are received in such transaction.

2. Waivers.

(a) The Sponsor hereby waives, subject to, and conditioned upon, the occurrence of the Closing (for himself, herself or itself and for his, her or its, successors, heirs and assigns), to the fullest extent permitted by law and the Governing Documents of DYNS, and agrees not to assert or perfect, any rights to adjustment or other anti-dilution protections with respect to the rate that the shares of Class B Common Stock held by the Sponsor convert into shares of Class A Common Stock in connection with the transactions contemplated by the Business Combination Agreement. For the avoidance of doubt, the foregoing waiver does not waive the Sponsor's rights under Section 4.3(b) of DYNS's Amended and Restated Certificate of Incorporation, which provides that in no event may any Class B Common Stock convert into shares of Class A Common Stock at a ratio that is less than one-for-one.

(b) The Sponsor hereby waives any and all Redemption Rights in respect to the Required Transaction Proposals, and shall not elect to cause DYNS to redeem any Subject DYNS Equity Securities beneficially owned or owned of record by the Sponsor in connection with the Required Transaction Proposals.

(c) The Sponsor hereby waives any and all right, title, interest or claim of any kind in or to any distribution of the Trust Account with respect to the Subject DYNS Equity Securities.

3. Transfer of Shares.

(a) From the date hereof until the earlier of (i) the Closing or (ii) the valid termination of this Agreement pursuant to Section 6, the Sponsor hereby agrees that the Sponsor shall not, directly or indirectly, (i) sell, assign, transfer (including by operation of law), place a lien on, pledge, dispose of or otherwise encumber any of his, her or its Subject DYNS Equity Securities or otherwise agree to do any of the foregoing (each, a "**Transfer**"), (ii) deposit any of the Sponsor's Subject DYNS Equity Securities into a

voting trust or enter into a voting agreement or arrangement or grant any proxy or power of attorney with respect to any of the Sponsor's Subject DYNS Equity Securities that conflicts with any of the covenants or agreements set forth in this Agreement, (iii) enter into any contract, option or other arrangement or undertaking with respect to the direct or indirect sale, assignment, transfer (including by operation of law) or other disposition of any of the Sponsor's Subject DYNS Equity Securities, (iv) engage in any hedging or other transaction which is designed to, or which would (either alone or in connection with one or more events or developments (including the satisfaction or waiver of any conditions precedent)), result in a sale or disposition of the Sponsor's Subject DYNS Equity Securities or (v) take any action that would have the effect of preventing or materially delaying the performance of the Sponsor's obligations hereunder, except (A) as affirmatively permitted by the Business Combination Agreement or (B) any Transfer that would be permitted pursuant to Section 5(c) of the Insider Letter.

(b) From the Closing until the earlier of (i) the Lock-Up Release Date or (ii) the valid termination of this Agreement pursuant to Section 6, the Sponsor hereby agrees that the Sponsor shall not, directly or indirectly, Transfer any of the Sponsor's Subject DYNS Equity Securities; *provided, however*, that the foregoing shall not apply to any Transfer (A) to DYNS's officers or directors, any affiliates or family member of any of DYNS's officers or directors, any members or partners of the Sponsor or their affiliates, any affiliates of the Sponsor, or any employees of such affiliates; (B) in the case of an individual, by gift to a member of one of the individual's immediate family or to a trust, the beneficiary of which is a member of the individual's immediate family, an affiliate of such person or to a charitable organization; (C) in the case of an individual, by virtue of laws of descent and distribution upon death of the individual; (D) in the case of an individual, pursuant to a qualified domestic relations order; (E) by private sales or transfers made in connection with the transactions contemplated by the Business Combination Agreement; and (F) by virtue of the Sponsor's organizational documents upon liquidation or dissolution of the Sponsor; *provided*, that any transferee of any Transfer of the type set forth in clauses (A) through (F) must enter into a written agreement in form and substance reasonably satisfactory to the Company agreeing to be bound by this Agreement prior to the occurrence of such Transfer. For purposes of this Agreement, the "**Lock-Up Release Date**" means the earliest of (A) the one year anniversary of the Closing and (B) subsequent to the Closing, (x) if the last reported sale price of the Class A Common Stock equals or exceeds \$12.00 per share (as adjusted for stock splits, stock dividends, reorganizations, recapitalizations and the like) for any 20 trading days within any 30 consecutive trading day period commencing at least 150 days after the Closing, or (y) the date upon completion of a liquidation, merger, stock exchange, reorganization or other similar transaction that results in all of the public stockholders of DYNS having the right to exchange their DYNS Common Stock for cash, securities or other property.

(c) In furtherance of the foregoing, DYNS hereby agrees to (i) place a revocable stop order on all Subject DYNS Equity Securities subject to Section 3(a) and Section 3(b), including those which may be covered by a registration statement, and (ii) notify DYNS's transfer agent in writing of such stop order and the restrictions on such Subject DYNS Equity Securities under Section 3(a) and Section 3(b) and direct DYNS's

transfer agent not to process any attempts by the Sponsor to Transfer any Subject DYNS Equity Securities except in compliance with Section 3(a) or Section 3(b); for the avoidance of doubt, the obligations of DYNS under this Section 3(c) shall be deemed to be satisfied by the existence of any similar stop order and restrictions currently existing on the Subject DYNS Equity Securities.

4. *Other Covenants.* The Sponsor hereby agrees to be bound by and subject to (i) Sections 5.3(a) (Confidentiality and Access to Information) and 5.4(a) (Public Announcements) of the Business Combination Agreement to the same extent as such provisions apply to the parties to the Business Combination Agreement, as if the Sponsor is directly a party thereto, and (ii) Section 5.6(c) (Exclusive Dealing) of the Business Combination Agreement to the same extent as such provisions apply to DYNS as if the Sponsor is directly party thereto.

5. *Termination of DYNS Class B Common Stock Lock-up Period.* Each DYNS Insider and DYNS hereby agree that effective as of the consummation of the Closing (and not before), Section 5 of the Insider Letter shall be amended and restated in its entirety as follows:

“5. *Reserved.*”

The amendment and restatement of the Insider Letter set forth in this Section 5 shall be void and of no force and effect if the Business Combination Agreement shall be terminated for any reason in accordance with its terms.

6. *Termination.* This Agreement shall automatically terminate, without any notice or other action by any Party, and be void *ab initio* upon the earlier of (a) the Effective Time; and (b) the termination of the Business Combination Agreement in accordance with its terms. Upon termination of this Agreement as provided in the immediately preceding sentence, none of the Parties shall have any further obligations or Liabilities under, or with respect to, this Agreement. Notwithstanding the foregoing or anything to the contrary in this Agreement, (i) the termination of this Agreement pursuant to Section 6(b) shall not affect any Liability on the part of any Party for a Willful Breach of any covenant or agreement set forth in this Agreement prior to such termination or Fraud, (ii) Sections 2, 5 and 10 (solely to the extent related to the foregoing Sections 2 or 5) shall each survive the termination of this Agreement pursuant to Section 6(a), and (iii) Sections 7, 8, 9 and 10 (solely to the extent related to the following Sections 7 or 9) shall survive any termination of this Agreement. For purposes of this Section 6, (x) “**Willful Breach**” means an intentional and willful breach, or an intentional and willful failure to perform, in each case that is the consequence of an act or omission by a Party with the knowledge that the taking of such act or failure to take such act would cause a breach of this Agreement and (y) “**Fraud**” means an act or omission by a Party consisting of a false or incorrect representation or warranty expressly set forth in this Agreement with the intent that another Party rely on such representations and warranties, coupled with such other Party’s detrimental reliance on such representations and warranties under circumstances that constitute common law fraud under the Laws of the State of New York. For the avoidance of doubt, “**Fraud**” does not include any claim for equitable fraud, promissory fraud, unfair dealings fraud, or any torts based on negligence or recklessness.

7. *No Recourse.* Except for claims pursuant to the Business Combination Agreement or any other Ancillary Document by any party(ies) thereto against any other party(ies) thereto, each Party agrees that (a) this Agreement may only be enforced against, and any action for breach of this Agreement may only be made against, the Parties, and no claims of any nature whatsoever (whether in tort, contract or otherwise) arising under or relating to this Agreement, the negotiation hereof or its subject matter, or the transactions contemplated hereby shall be asserted against any non-party affiliate of the Company or DYNS, as applicable (other than the DYNS Insiders named as parties hereto, on the terms and subject to the conditions set forth herein), and (b) none of the Company's non-party affiliates or DYNS's non-party affiliates (other than the DYNS Insiders named as parties hereto, on the terms and subject to the conditions set forth herein) shall have any Liability arising out of or relating to this Agreement, the negotiation hereof or its subject matter, or the transactions contemplated hereby, including with respect to any claim (whether in tort, contract or otherwise) for breach of this Agreement or in respect of any written or oral representations made or alleged to be made in connection herewith, as expressly provided herein, or for any actual or alleged inaccuracies, misstatements or omissions with respect to any information or materials of any kind furnished in connection with this Agreement, the negotiation hereof or the transactions contemplated hereby.

8. *Fiduciary Duties.* Notwithstanding anything in this Agreement to the contrary, (a) the Sponsor makes no agreement or understanding herein in any capacity other than in the Sponsor's capacity as a record holder and beneficial owner of the Subject DYNS Equity Securities, and not in the Sponsor's (or any of its representatives') capacity as a director, officer or employee of any DYNS Party, and (b) nothing herein will be construed to limit or affect any action or inaction by the Sponsor or any representative of the Sponsor serving as a member of the board of directors (or other similar governing body) of any DYNS Party or as an officer, employee or fiduciary of any DYNS Party, in each case, acting in such person's capacity as a director, officer, employee or fiduciary of such DYNS Party.

9. *No Third Party Beneficiaries.* This Agreement shall be for the sole benefit of the Parties and their respective successors and permitted assigns and is not intended, nor shall be construed, to give any Person, other than the Parties and their respective successors and assigns, any legal or equitable right, benefit or remedy of any nature whatsoever in connection with the matters governed by this Agreement. Nothing in this Agreement, expressed or implied, is intended to or shall constitute the Parties, partners or participants in a joint venture.

10. *Incorporation by Reference.* Sections 8.1 (Non-Survival), 8.2 (Entire Agreement; Assignment), 8.3 (Amendment), 8.4 (Notices), 8.5 (Governing Law), 8.7 (Construction; Interpretation), 8.10 (Severability), 8.11 (Counterparts; Electronic Signatures), 8.15 (Waiver of Jury Trial), 8.16 (Submission to Jurisdiction) and 8.17 (Remedies) of the Business Combination Agreement are incorporated herein and shall apply to this Agreement *mutatis mutandis*.

[signature page follows]

IN WITNESS WHEREOF, each of the Parties has caused this Agreement to be duly executed on its behalf as of the day and year first above written.

DYNAMICS SPECIAL PURPOSE CORP.

By: _____
Name: Mostafa Ronaghi
Title: Chief Executive Officer

DYNAMICS SPONSOR LLC

By: _____
Name: Mostafa Ronaghi
Title: President

SENTI BIOSCIENCES, INC.

By: _____
Name: Timothy Lu
Title: Chief Executive Officer

Solely for purposes of Section 5 of this Agreement, the following Other DYNs Insiders

Omid Farokhzad

Mostafa Ronaghi

Mark Afrasiabi

Rowan Chapman

David Epstein

Jay Flatley

Dipchand Nishar

Robert Langer

COMPANY STOCKHOLDER SUPPORT AGREEMENT

This Company Stockholder Support Agreement (this "**Agreement**"), dated as of _____, 2021, is among Dynamics Special Purpose Corp., a Delaware corporation ("**Parent**"), Senti Biosciences, Inc., a Delaware corporation (the "**Company**") and each of the undersigned holders (together with each such holder who executes a signature page to this Agreement after the date hereof, the "**Holders**") of capital stock of the Company. Each of Parent, the Company and the Holders may hereinafter be referred to as a "**Party**" and collectively as the "**Parties**".

RECITALS

WHEREAS, Parent, Explore Merger Sub, Inc., a Delaware corporation ("**Merger Sub**"), and the Company have entered into a Business Combination Agreement (as such agreement may be amended from time to time, the "**Business Combination Agreement**"), pursuant to which Merger Sub will merge with and into the Company, with the Company surviving as the surviving corporation (the "**Merger**"), all upon the terms and subject to the conditions set forth in the Business Combination Agreement;

WHEREAS, each Holder beneficially owns (as defined in Rule 13d-3 under the Securities Exchange Act of 1934, as amended (the "**Exchange Act**")), and has sole voting power with respect to the number and type of the Company Shares indicated opposite such Holder's name on Schedule 1 attached hereto (or, in the case of any Holder who executes a signature page to this Agreement after the date hereof, attached to such Holder's signature page) (as used herein, the term "**Shares**" means all the Company Shares held by the Holders as of the date hereof and any Company Shares or other equity interests or shares of the capital stock of the Company that such Holder may hereafter acquire, including, without limitation, through acquiring ownership of record or the power to vote (including, without limitation, by proxy or power of attorney) prior to the termination of the obligations of such Holder under this Agreement);

WHEREAS, this Agreement is a material inducement to Parent's and Merger Sub's willingness to enter into the Business Combination Agreement and the Ancillary Documents and consummate the transactions contemplated thereby, including the Merger, pursuant to which such Holder will directly or indirectly receive a material benefit; and

WHEREAS, all capitalized terms used but not defined in this Agreement shall have the respective meanings ascribed to them in the Business Combination Agreement.

NOW, THEREFORE, in consideration of the foregoing recitals, the mutual covenants and agreements contained herein, and other good and valuable consideration, the receipt and sufficiency of which are hereby acknowledged, and intending to be legally bound hereby, Parent and the Holders agree as follows:

Section 1. Agreement to Vote Shares.

(a) Each Holder, solely in their capacity as a stockholder of the Company, agrees that, unless the Expiration Date has occurred, it shall validly execute and deliver to the Company, within forty eight (48) hours after the date that the Proxy Statement/Prospectus is

disseminated by the Company to the Company's stockholders following the date that the Registration Statement becomes effective, a written consent approving the Business Combination Agreement, the Merger, and any other matters necessary or reasonably requested by the Company for consummation of the Merger and the other transactions contemplated by the Business Combination Agreement in respect of the Shares. In addition, unless the Expiration Date has occurred, each Holder irrevocably and unconditionally agrees that at any meeting of the holders of Company Shares, or any adjournment or postponement thereof, or in connection with any written consent of the holders of Company Shares, with respect to the Business Combination Agreement or any of the transactions contemplated thereby, including the Merger, such Holder shall:

(i) appear at any such meeting or otherwise cause the Shares to be counted as present thereat for purposes of calculating a quorum;

and

(ii) vote (or cause to be voted) (i) in favor of adoption and approval of the Business Combination Agreement, the Merger, and any other matters necessary or reasonably requested by the Company for consummation of the Merger and the other transactions contemplated by the Business Combination Agreement, and (ii) against any proposal that would constitute a breach thereof or that conflicts or materially impedes or interferes therewith, including any Company Acquisition Proposal, or would adversely affect or delay the consummation of the transactions contemplated by the Business Combination Agreement.

(b) Without limiting any other rights or remedies of Parent, each Holder hereby irrevocably appoints Parent or any individual designated by Parent as such Holder's agent, attorney-in-fact and proxy (with full power of substitution and resubstituting), for and in the name, place and stead of such Holder, up to the Expiration Date, to attend on behalf of such Holder any meeting of the Company Stockholders with respect to the matters described in Section 1(a)(ii), to include the Shares held by such Holder in any computation for purposes of establishing a quorum at any such meeting of the Company Stockholders, to vote (or cause to be voted) such Shares or consent (or withhold consent) with respect to any of the matters described in Section 1(a)(ii) in connection with any meeting of the Company Stockholders or any action by written consent by the Company Stockholders (including the Company Stockholder Written Consent), in each case, only in the event and to the extent that the Holder fails to timely perform or otherwise comply with the covenants, agreements or obligations set forth in Section 1(a). The proxyholder may not exercise the proxy granted pursuant to this Section 1(b) on any matter except those provided in Section 1(a), and each Holder may vote its, his or her Shares on all other matters, subject to the other applicable covenants, agreements and obligations set forth in this Agreement.

(c) The proxy granted by each Holder pursuant to Section 1(b) (i) will be automatically revoked upon the Expiration Date, (ii) is coupled with an interest sufficient in law to support, subject to clause (i), an irrevocable proxy and is granted in consideration for Parent entering into the Business Combination Agreement and agreeing to consummate the transactions contemplated thereby, and (iii) is a durable proxy and shall survive the bankruptcy, dissolution, death, incapacity or other inability to act by such Holder and shall revoke any and all prior proxies granted by such Holder with respect to the Shares held by such Holder. The vote or consent of the

proxyholder in accordance with Section 1(b) and with respect to the matters in Section 1(a)(ii) shall control in the event of any conflict between such vote or consent by such proxyholder and a vote or consent by each Holder (or any other Person with the power to vote the Shares held by such Holder) with respect to the matters in Section 1(a)(ii).

(d) Prior to the Expiration Date, except as expressly set forth herein, no Holder shall enter into any agreement, understanding or arrangement (whether written or oral) with any Person to vote or give instructions in any manner inconsistent with this Section 1. Any such vote shall be cast, or consent shall be given, in accordance with such procedures relating thereto so as to ensure that it is duly counted for purposes of determining that a quorum is present and for purposes of recording the results of such vote or consent.

(e) In the event of any equity dividend or distribution, or any change in the equity interests of the Company by reason of any equity dividend or distribution, equity split, recapitalization, combination, conversion, exchange of equity interests or the like prior to the Closing (including the transactions contemplated by the Business Combination Agreement), the term “Shares” shall be deemed to refer to and include the Shares as well as all such equity dividends and distributions and any securities into which or for which any or all of the Shares may be changed or exchanged or which are received in such transaction (including the DYNs Common Stock received as result of the consummation of the Merger pursuant to the Business Combination Agreement). For the avoidance of doubt, in no event shall the term “Shares” be deemed to refer to or include any securities issued to any Holder pursuant to any Subscription Agreement.

Section 2. Transfer of Shares.

(a) Each Holder agrees that, prior to the Expiration Date, he, she or it shall not sell, assign, transfer (including by operation of law), place a lien on, pledge, dispose of or otherwise encumber any of his, her or its Shares or otherwise agree to do any of the foregoing (collectively, a “**Transfer**”), except (a) in compliance with all applicable federal and state securities Laws, (b) in compliance with the Governing Documents of the Company (it being understood and agreed that any waiver or consent to any Transfer pursuant to the Governing Documents of the Company shall require the mutual consent of Parent and the Company), (c) in compliance with the Business Combination Agreement and (d) if, prior to such Transfer, each transferee signs a counterpart to this Agreement pursuant to which such transferee agrees to be bound by the terms of this Agreement and to be a “Holder” hereunder; *provided* that, any subsequent transfer of the Shares by any such transferee shall also be made pursuant to, and in accordance with, all of the provisions of this Section 2 to the same extent as if each such transferee were a Holder. Each Holder shall not, directly or indirectly,

(i) pledge, encumber or create a Lien on any Shares or enter into any contract, option, commitment or other arrangement or understanding with respect to the foregoing;

(ii) grant any proxies or powers of attorney or enter into a voting agreement or other arrangement with respect to any of such Holder’s Shares;

(iii) enter into, or deposit any of such Holder's Shares into, a voting trust or take any other action which would, or would reasonably be expected to, result in a diminution of the voting power represented by any of such Holder's Shares; or

(iv) commit or agree to take any of the foregoing actions.

As used in this Agreement, the term "**Expiration Date**" shall mean the earliest to occur of (i) the Effective Time, (ii) such date and time as the Business Combination Agreement shall be terminated pursuant to Article 7 thereof and (iii) upon mutual written agreement of the Parties.

(b) From the Effective Time until the earlier of (i) the Lock-Up Release Date or (ii) the valid termination of this Agreement pursuant to Section 13, each Holder hereby agrees that it shall not, directly or indirectly, Transfer any of the Shares (including, for the avoidance of doubt, the DYNS Common Stock received as result of the consummation of the Merger pursuant to the Business Combination Agreement); *provided, however*, that the foregoing shall not apply to any Transfer (A) to such Holder's officers or directors, any affiliates or family member thereof or any of their affiliates; (B) in the case of an individual, by gift to a member of one of the individual's immediate family or to a trust, the beneficiary of which is a member of the individual's immediate family, an affiliate of such person or to a charitable organization; (C) in the case of an individual, by virtue of laws of descent and distribution upon death of the individual; (D) in the case of an individual, pursuant to a qualified domestic relations order; (E) by private sales or transfers made in connection with the transactions contemplated by the Business Combination Agreement; (F) pro rata to the direct or indirect partners, members or shareholders of such Holder or any related investment funds or vehicles controlled or managed by such persons or their respective affiliates in connection with the liquidation or dissolution thereof, and (G) by virtue of such Holder's organizational documents upon liquidation or dissolution thereof; *provided*, that any transferee of any Transfer of the type set forth in clauses (A) through (G) must enter into a written agreement in form and substance reasonably satisfactory to Parent agreeing to be bound by this Agreement prior to the occurrence of such Transfer. For purposes of this Agreement, the "**Lock-Up Release Date**" means the earliest of (A) the one year anniversary of the Closing and (B) subsequent to the Closing, (x) if the last reported sale price of the Class A Common Stock equals or exceeds \$12.00 per share (as adjusted for stock splits, stock dividends, reorganizations, recapitalizations and the like) for any 20 trading days within any 30 consecutive trading day period commencing at least 150 days after the Closing, or (y) the date upon completion of a liquidation, merger, stock exchange, reorganization or other similar transaction that results in all of the public stockholders of Parent having the right to exchange their DYNS Common Stock for cash, securities or other property. In furtherance of the foregoing, Parent hereby agrees to (i) place a revocable stop order on all Shares subject to Section 2(b), including those which may be covered by a registration statement, and (ii) notify Parent's transfer agent in writing of such stop order and the restrictions on such Shares under Section 2(b) and direct Parent's transfer agent not to process any attempts by any Holder to Transfer any Shares except in compliance with this Section 2(b).

Notwithstanding the foregoing, to the extent any Holder is granted a release or waiver to a substantially similar lockup to those set forth in the restrictions contained in this Section 2 prior to the expiration of the Lock-Up Period, then all Holders subject to such restrictions shall be automatically granted a release or waiver from the restrictions contained in this Section 2 to the same extent, on substantially the same terms as and on a pro rata basis with, the Holder to which such release or waiver is granted.

Section 3. Certain Covenants of the Holder.

(a) Each Holder and the Company hereby agrees that, notwithstanding anything to the contrary in any such agreement, (i) each of the agreements set forth on Schedule 2 hereto shall be automatically terminated and of no further force and effect (including any provisions of any such agreement that, by its terms, survive such termination) effective as of, and subject to and conditioned upon the occurrence of, the Effective Time and (ii) upon such termination neither the Company nor any of its Affiliates shall have any further obligations or Liabilities under or with respect to each such agreement. Without limiting the above, each of the Equity Holders who are a party to the agreements set forth on Schedule 2 hereby expressly and irrevocably acknowledge and agree that all terms and conditions of the respective agreements to which they are a party to were duly observed or waived, as applicable.

(b) Each Holder hereby agrees to be bound by and subject to (i) Sections 5.3(a) (Confidentiality) and 5.4(a) (Public Announcements) of the Business Combination Agreement to the same extent as such provisions apply to the parties to the Business Combination Agreement, as if such Holder is directly party thereto, and (ii) Section 5.6(a) (Exclusive Dealing) of the Business Combination Agreement to the same extent as such provisions apply to the Company, as if the Holder is directly party thereto.

Section 4. Representations and Warranties of Holders. Each Holder hereby represents and warrants to Parent as follows:

(a) such Holder has the full power and authority to execute and deliver this Agreement and to perform such Holder's obligations hereunder;

(b) this Agreement has been duly executed and delivered by such Holder and, assuming due authorization, execution and delivered by the other Parties, constitutes a valid, legal and binding agreement with respect to such Holder, enforceable against such Holder in accordance with its terms, subject to applicable bankruptcy, insolvency, reorganization, fraudulent transfer, moratorium or similar Laws affecting creditors' rights generally and general principles of equity;

(c) if such Holder is the beneficial owner of any Shares held in trust, no consent of any beneficiary of such trust is required in connection with the execution and delivery of this Agreement and the consummation of the transactions contemplated hereby or by the Business Combination Agreement;

(d) such Holder beneficially owns the number of Shares indicated opposite such Holder's name on Schedule 1 hereto, free and clear of any Liens (other than Liens created by this Agreement, applicable securities laws, the Company's Amended and Restated Certificate of Incorporation, the Company's existing bylaws, that certain Amended and Restated Investors' Rights Agreement made as of October 22, 2020 by and among the Company and certain of its stockholders, and Permitted Liens), that certain Voting Agreement entered into as of October 22, 2020 by an among the Company and certain of its stockholders, as amended by Amendment No.

1 to the Voting Agreement, and has sole, and otherwise unrestricted, voting and investment power with respect to such Shares; none of the Shares are subject to any voting trust or other agreement, arrangement or restriction with respect to the voting of the Shares; and no Person has any right to acquire from such Holder any of the Shares indicated opposite such Holder's name on Schedule 1 hereto;

(e) such Holder agrees to promptly notify Parent in writing of any changes or updates to Schedule 1 hereto as it relates to such Holder after the date hereof;

(f) such Holder understands that, at the Effective Time, each outstanding Share shall be converted into the right to receive the Merger Consideration as set forth in the Business Combination Agreement;

(g) the execution and delivery of this Agreement by such Holder, the consummation by such Holder of the transactions contemplated hereunder and the performance by such Holder of his, her or its obligations hereunder do not and will not conflict with, or result in any violation or breach of, or default (with or without notice or lapse of time or both) under, any Contract or any judgment to which such Holder is a party or by which such Holder is bound, or any Law to which such Holder is subject or, in the event that such Holder is a corporation, company, partnership, limited liability company, joint venture, association, trust, business trust or other entity, any Governing Document of such Holder;

(h) the execution and delivery of this Agreement by such Holder, the consummation by such Holder of the transactions contemplated hereunder and the performance by such Holder of his, her or its obligations hereunder do not and will not require any consent, approval, qualification, order or authorization of, registration, declaration or filing with, or notice to, any Governmental Entity by such Holder except for applicable requirements, if any, of the Exchange Act, and except where the failure to obtain such consents, approvals, qualifications, orders or authorizations or registrations, declarations or filings, would not prevent or impair in any material respect the performance by such Holder of his, her or its obligations under this Agreement; and

(i) no investment banker, broker, finder, consultant or intermediary or other Person is entitled to any broker's, finder's, financial advisor's or other similar fee or commission based upon arrangements made by or on behalf of such Holder in connection with its entering into this Agreement.

Section 5. Remedies. Notwithstanding anything to the contrary set forth in the Business Combination Agreement, the Parties agree that irreparable damage for which monetary damages, even if available, would not be an adequate remedy, would occur in the event that the Parties do not perform their respective obligations under the provisions of this Agreement in accordance with their specific terms or otherwise breach such provisions. It is accordingly agreed that the Parties shall be entitled to an injunction or injunctions, specific performance and other equitable relief to prevent breaches of this Agreement and to enforce specifically the terms and provisions of this Agreement, in each case, without posting a bond or undertaking and without proof of damages and this being in addition to any other remedy to which they are entitled at law

or in equity. Each of the Parties agrees that it will not oppose the granting of an injunction, specific performance and other equitable relief when expressly available pursuant to the terms of this Agreement on the basis that the other Parties have an adequate remedy at law or an award of specific performance is not an appropriate remedy for any reason at law or equity.

Section 6. No Waivers. No waiver of any breach of this Agreement extended by Parent to a Holder shall be construed as a waiver of any rights or remedies of Parent with respect to any other Holder or with respect to any subsequent breach of such Holder or any other such Holder. No waiver of any provisions hereof by either Party shall be deemed a waiver of any other provisions hereof by any such Party, nor shall any such waiver be deemed a continuing waiver of any provision hereof by such Party.

Section 7. Appraisal Rights; Claims. Each Holder hereby agrees (a) not to exercise any appraisal rights or any dissenters' rights that such Holder may have (whether under applicable Law or otherwise) or could potentially have or acquire in connection with the Business Combination Agreement and the transactions contemplated by the Business Combination Agreement, including the Merger, and (b) not to commence or participate in any claim, derivative or otherwise, against the Company, Parent, Merger Sub or any of their respective Affiliates relating to the negotiation, execution or delivery of this Agreement or the Business Combination Agreement or the consummation of the Merger, including any claim (i) challenging the validity of, or seeking to enjoin the operation of, any provision of this Agreement or (ii) alleging a breach of any fiduciary duty of the Company Board in connection with this Agreement, the Business Combination Agreement or the Merger.

Section 8. Fees and Expenses. Except as otherwise provided herein or in the Business Combination Agreement, all fees and expenses incurred in connection with or related to this Agreement and the Business Combination Agreement and the transactions contemplated hereby and thereby will be paid by the party incurring such fees or expenses, whether or not such transactions are consummated.

Section 9. Trust Account Waiver. Reference is made to the final prospectus of Parent, filed with the Securities Exchange Commission (the "SEC") (File No. 333-255930) on May 27, 2021 (the "Prospectus"). The Holder acknowledges and agrees and understands that Parent has established a Trust Account containing the proceeds of IPO and from certain private placements occurring simultaneously with the IPO (including interest accrued from time to time thereon) for the benefit of Parent's Public Stockholders, and Parent may disburse monies from the Trust Account only in the express circumstances described in the Prospectus. The Holder hereby agrees that, notwithstanding anything to the contrary in this Agreement, it does not now and shall not at any time hereafter have any right, title, interest or claim of any kind in or to any monies in the Trust Account or distributions therefrom, or make any claim against the Trust Account (including any distributions therefrom), regardless of whether such claim arises based on contract, tort, equity or any other theory of legal liability.

Section 10. Notices. All notices, requests, claims, demands and other communications under this Agreement shall be in writing and shall be given (and shall be deemed to have been duly given) by delivery in person, by facsimile (having obtained electronic delivery confirmation thereof), e-mail (having obtained electronic delivery confirmation thereof), or by registered or certified mail (postage prepaid, return receipt requested) (upon receipt thereof) to the other Parties as follows:

(a) if to Parent:

Dynamics Special Purpose Corp.
2875 El Camino Real
Redwood City, CA 94061
Attention:

Email:

with copies (which shall not constitute notice) to:

Davis Polk & Wardwell LLP
450 Lexington Avenue
New York, New York 10017
Attention: Alan Denenberg
Email: alan.denenberg@davispolk.com

if to Company:

Senti Biosciences, Inc.
2 Corporate Drive, 1st Floor
South San Francisco, CA 94080
Attention: Timothy Lu, Deb Knobelman, Curt Herberts
Email: tim.lu@sentibio.com, deb.knobelman@sentibio.com,
curt.herberts@sentibio.com

with copies (which shall not constitute notice) to:

Goodwin Procter LLP
100 Northern Avenue
Boston, MA 02210
Attention: Jocelyn M. Arel
Michael R. Patrone
Facsimile: (617) 523-1231
E-mail: jarel@goodwinlaw.com
mpatrone@goodwinlaw.com

(b) if to a Holder, to the address or facsimile number set forth under such Holder's signature on the signature page hereto.

Section 11. Assignment. Neither this Agreement nor any of the rights, interests or obligations hereunder shall be assigned, in whole or in part, by operation of Law or otherwise by any of the Parties without the prior written consent of the other Parties. Subject to the preceding sentence, this Agreement shall be binding upon, inure to the benefit of and be enforceable by, the Parties and their respective successors and assigns.

Section 12. Amendment. Except as otherwise specifically set forth in this Agreement, this Agreement may not be amended except by an instrument in writing signed on behalf of each of the Parties. Except as otherwise specifically set forth in this Agreement, any amendment, supplement or modification of or to any provision of this Agreement and any waiver of any provision of this Agreement shall be effective (a) only if it is made or given in writing and signed by Parent and all of the Holders or, in the case of a waiver, by Parent and (b) only in the specific instance and for the specific purpose for which made or given. Notwithstanding anything to the contrary contained herein, any holder of Shares may become party to this Agreement by executing and delivering a counterpart signature page hereto agreeing to be bound by and subject to the terms of this Agreement as a Holder hereunder. In such event, each such person shall thereafter shall be deemed a Holder for all purposes under this Agreement.

Section 13. Termination. This Agreement shall automatically terminate, without any notice or other action by any Party, and be void *ab initio* upon the earliest to occur of (a) the Effective Time, (b) such date and time as the Business Combination Agreement shall be terminated pursuant to Article 7 thereof, and (c) upon mutual written agreement of the Parties. Upon termination of this Agreement as provided in the immediately preceding sentence, none of the Parties shall have any further obligations or Liabilities under, or with respect to, this Agreement; *provided, however*, that (i) the termination of this Agreement pursuant to the foregoing clause (b) shall not affect any Liability on the part of any Party for a Willful Breach of any covenant or agreement set forth in this Agreement prior to such termination or Fraud; (ii) the provisions of Section 2(b) (*Transfer Restrictions*), Section 3(a) (*Termination of Related Party Agreements*) and Section 7(b) (*Claims*) shall survive the termination of this Agreement pursuant to the foregoing clause (a); and (iii) the provisions of Section 5 (*Remedies*), Section 7(a) (*Appraisal Rights*), Section 8 (*Fees and Expenses*), Section 9 (*Trust Account Waiver*), Section 10 (*Notices*), Section 11 (*Assignment*), Section 12 (*Amendment*), this Section 13 (*Termination*), Section 14 (*Entire Agreement*), Section 17 (*Further Assurances*), Section 20 (*Miscellaneous*) and Section 21 (*Parties Advised by Counsel*) of this Agreement shall remain in full force and effect and survive any termination of this Agreement.

Section 14. Entire Agreement. This Agreement, the schedules hereto and the Business Combination Agreement contain the entire agreement and understanding between the Parties with respect to the subject matter hereof and thereof and supersede all prior discussions, negotiations, commitments, agreements and understandings, both written and oral, relating to such subject matter.

Section 15. No Third-Party Beneficiaries. Except as otherwise provided in this Agreement, this Agreement is for the sole benefit of the Parties and their permitted successors and assigns and nothing herein expressed or implied shall give or be construed to give to any Person, other than the Parties and such successors and assigns, any legal or equitable rights hereunder.

Section 16. Capacity as a Holder. Notwithstanding anything herein to the contrary, the Holder signs this Agreement solely in the Holder's capacity as a stockholder of the Company, and not in any other capacity and this Agreement shall not limit or otherwise affect the actions of any affiliate, employee, or designee of the Holder or any of its affiliates in his or her capacity, if applicable, as an officer or director of the Company or any other Person.

Section 17. Further Assurances. From time to time and without additional consideration, each Holder agrees that it (i) shall not take any action that would reasonably be expected to prevent, impede, interfere with or adversely affect such Holder's, the Company's and/or Parent's ability to perform its obligations under this Agreement and/or the Business Combination Agreement, except as expressly contemplated by this Agreement or the Business Combination Agreement, and (ii) shall execute and deliver, or cause to be executed and delivered, such additional transfers, assignments, endorsements, proxies, consents and other instruments, and shall take such further actions, as Parent may reasonably request for the purpose of carrying out and furthering the intent of this Agreement. In addition, each Holder that is a Company IRA Stockholder agrees to execute and deliver a counterpart of the Investor Rights Agreement, to become effective as of, and contingent upon consummation of, the Closing.

Section 18. Disclosure. Each Holder agrees to provide to Parent, the Company and their respective Representatives any information regarding such Holder or such Holder's Shares that is reasonably requested by Parent, the Company or their respective Representatives and required in order for the Company and Parent to comply with Sections 5.4(b) and 5.7 of the Business Combination Agreement. Each Holder hereby authorizes Parent and the Company to publish and disclose in any announcement or disclosure required by the SEC or Nasdaq (including the Registration Statement/Proxy Statement), the Holder's identity and ownership of the Shares and the nature of the Holder's obligations under this Agreement.

Section 19. Certain Events. Each Holder agrees (severally with respect to itself and not jointly) that this Agreement and the obligations hereunder will attach to such Holder's Shares and will be binding upon any Person to which legal or beneficial ownership of such Holder's Shares passes, whether by operation of law or otherwise, including such Holder's heirs, guardians, administrators or successors.

Section 20. Miscellaneous. The provisions of Section 8.5 (*Governing Law*), Section 8.7 (*Construction; Interpretation*), Section 8.10 (*Severability*), Section 8.11 (*Counterparts; Electronic Signatures*), Section 8.15 (*Waiver of Jury Trial*) and Section 8.16 (*Submission to Jurisdiction*) of the Business Combination Agreement shall apply to this Agreement *mutatis mutandis* as if set forth herein.

Section 21. Parties Advised by Counsel. This Agreement has been negotiated between unrelated parties who are sophisticated and knowledgeable in the matters contained in this Agreement and who have acted in their own self interest. In addition, each Party has had the opportunity to seek advice of legal counsel. This Agreement will not be interpreted or construed against any Party because that Party or any attorney or representative for that Party drafted or participated in the drafting of this Agreement.

[Signature pages follow]

IN WITNESS WHEREOF, the Parties have executed this Agreement as of the date first set forth above.

DYNAMICS SPECIAL PURPOSE CORP.

By: _____

Name: Mostafa Ronaghi
Title: Chief Executive Officer

SENTI BIOSCIENCES, INC.

By: _____

Name: Timothy Lu
Title: Chief Executive Officer

[SIGNATURE PAGE TO SUPPORT AGREEMENT]

[[HOLDER]]

[Type in name of individual Holder]]

[for an entity, use the following signature block instead]

[[HOLDER]]

[Type in name of Holder entity]

By: _____

Name:

Title:]

Address for Notice:

Email for Notice:

Facsimile for Notice:

[SIGNATURE PAGE TO SUPPORT AGREEMENT]

SCHEDULE 1

Holder

Number of Shares Held

Type
Common
Preferred

Address

[SCHEDULE 1 TO SUPPORT AGREEMENT]

SCHEDULE 2

Terminated Related Party Agreements

[SCHEDULE 2 TO SUPPORT AGREEMENT]

COMPANY STOCKHOLDER SUPPORT AGREEMENT

This Company Stockholder Support Agreement (this “**Agreement**”), dated as of December 19, 2021, is among Dynamics Special Purpose Corp., a Delaware corporation (“**Parent**”), Senti Biosciences, Inc., a Delaware corporation (the “**Company**”) and each of the undersigned holders (together with each such holder who executes a signature page to this Agreement after the date hereof, the “**Holder**”) of capital stock of the Company. Each of Parent, the Company and the Holders may hereinafter be referred to as a “**Party**” and collectively as the “**Parties**”.

RECITALS

WHEREAS, Parent, Explore Merger Sub, Inc., a Delaware corporation (“**Merger Sub**”), and the Company have entered into a Business Combination Agreement (as such agreement may be amended from time to time, the “**Business Combination Agreement**”), pursuant to which Merger Sub will merge with and into the Company, with the Company surviving as the surviving corporation (the “**Merger**”), all upon the terms and subject to the conditions set forth in the Business Combination Agreement;

WHEREAS, each Holder beneficially owns (as defined in Rule 13d-3 under the Securities Exchange Act of 1934, as amended (the “**Exchange Act**”), and has sole voting power with respect to the number and type of the Company Shares indicated opposite such Holder’s name on Schedule 1 attached hereto (or, in the case of any Holder who executes a signature page to this Agreement after the date hereof, attached to such Holder’s signature page) (as used herein, the term “**Shares**” means all the Company Shares held by the Holders as of the date hereof and any Company Shares or other equity interests or shares of the capital stock of the Company that such Holder may hereafter acquire, including, without limitation, through acquiring ownership of record or the power to vote (including, without limitation, by proxy or power of attorney) prior to the termination of the obligations of such Holder under this Agreement);

WHEREAS, this Agreement is a material inducement to Parent’s and Merger Sub’s willingness to enter into the Business Combination Agreement and the Ancillary Documents and consummate the transactions contemplated thereby, including the Merger, pursuant to which such Holder will directly or indirectly receive a material benefit; and

WHEREAS, all capitalized terms used but not defined in this Agreement shall have the respective meanings ascribed to them in the Business Combination Agreement.

NOW, THEREFORE, in consideration of the foregoing recitals, the mutual covenants and agreements contained herein, and other good and valuable consideration, the receipt and sufficiency of which are hereby acknowledged, and intending to be legally bound hereby, Parent and the Holders agree as follows:

Section 1. Agreement to Vote Shares.

(a) Each Holder, solely in their capacity as a stockholder of the Company, agrees that, unless the Expiration Date has occurred, it shall validly execute and deliver to the Company, within forty eight (48) hours after the date that the Proxy Statement/Prospectus is disseminated by the Company to the Company's stockholders following the date that the Registration Statement becomes effective, a written consent approving the Business Combination Agreement, the Merger, and any other matters necessary or reasonably requested by the Company for consummation of the Merger and the other transactions contemplated by the Business Combination Agreement in respect of the Shares. In addition, unless the Expiration Date has occurred, each Holder irrevocably and unconditionally agrees that at any meeting of the holders of Company Shares, or any adjournment or postponement thereof, or in connection with any written consent of the holders of Company Shares, with respect to the Business Combination Agreement or any of the transactions contemplated thereby, including the Merger, such Holder shall:

(i) appear at any such meeting or otherwise cause the Shares to be counted as present thereat for purposes of calculating a quorum;
and

(ii) vote (or cause to be voted) (i) in favor of adoption and approval of the Business Combination Agreement, the Merger, and any other matters necessary or reasonably requested by the Company for consummation of the Merger and the other transactions contemplated by the Business Combination Agreement, and (ii) against any proposal that would constitute a breach thereof or that conflicts or materially impedes or interferes therewith, including any Company Acquisition Proposal, or would adversely affect or delay the consummation of the transactions contemplated by the Business Combination Agreement.

(b) Without limiting any other rights or remedies of Parent, each Holder hereby irrevocably appoints Parent or any individual designated by Parent as such Holder's agent, attorney-in-fact and proxy (with full power of substitution and resubstituting), for and in the name, place and stead of such Holder, up to the Expiration Date, to attend on behalf of such Holder any meeting of the Company Stockholders with respect to the matters described in Section 1(a)(ii), to include the Shares held by such Holder in any computation for purposes of establishing a quorum at any such meeting of the Company Stockholders, to vote (or cause to be voted) such Shares or consent (or withhold consent) with respect to any of the matters described in Section 1(a)(ii) in connection with any meeting of the Company Stockholders or any action by written consent by the Company Stockholders (including the Company Stockholder Written Consent), in each case, only in the event and to the extent that the Holder fails to timely perform or otherwise comply with the covenants, agreements or obligations set forth in Section 1(a). The proxyholder may not exercise the proxy granted pursuant to this Section 1(b) on any matter except those provided in Section 1(a), and each Holder may vote its, his or her Shares on all other matters, subject to the other applicable covenants, agreements and obligations set forth in this Agreement.

(c) The proxy granted by each Holder pursuant to Section 1(b) (i) will be automatically revoked upon the Expiration Date, (ii) is coupled with an interest sufficient in law to support, subject to clause (i), an irrevocable proxy and is granted in consideration for Parent entering into the Business Combination Agreement and agreeing to consummate the transactions contemplated thereby, and (iii) is a durable proxy and shall survive the bankruptcy, dissolution, death, incapacity or other inability to act by such Holder and shall revoke any and all prior proxies granted by such Holder with respect to the Shares held by such Holder. The vote or consent of the

proxyholder in accordance with Section 1(b) and with respect to the matters in Section 1(a)(ii) shall control in the event of any conflict between such vote or consent by such proxyholder and a vote or consent by each Holder (or any other Person with the power to vote the Shares held by such Holder) with respect to the matters in Section 1(a)(ii).

(d) Prior to the Expiration Date, except as expressly set forth herein, no Holder shall enter into any agreement, understanding or arrangement (whether written or oral) with any Person to vote or give instructions in any manner inconsistent with this Section 1. Any such vote shall be cast, or consent shall be given, in accordance with such procedures relating thereto so as to ensure that it is duly counted for purposes of determining that a quorum is present and for purposes of recording the results of such vote or consent.

(e) In the event of any equity dividend or distribution, or any change in the equity interests of the Company by reason of any equity dividend or distribution, equity split, recapitalization, combination, conversion, exchange of equity interests or the like prior to the Closing (including the transactions contemplated by the Business Combination Agreement), the term "Shares" shall be deemed to refer to and include the Shares as well as all such equity dividends and distributions and any securities into which or for which any or all of the Shares may be changed or exchanged or which are received in such transaction (including the DYNs Common Stock received as result of the consummation of the Merger pursuant to the Business Combination Agreement). For the avoidance of doubt, in no event shall the term "Shares" be deemed to refer to or include any securities issued to any Holder pursuant to any Subscription Agreement.

Section 2. Transfer of Shares.

(a) Each Holder agrees that, prior to the Expiration Date, he, she or it shall not sell, assign, transfer (including by operation of law), place a lien on, pledge, dispose of or otherwise encumber any of his, her or its Shares or otherwise agree to do any of the foregoing (collectively, a "**Transfer**"), except (a) in compliance with all applicable federal and state securities Laws, (b) in compliance with the Governing Documents of the Company (it being understood and agreed that any waiver or consent to any Transfer pursuant to the Governing Documents of the Company shall require the mutual consent of Parent and the Company), (c) in compliance with the Business Combination Agreement and (d) if, prior to such Transfer, each transferee signs a counterpart to this Agreement pursuant to which such transferee agrees to be bound by the terms of this Agreement and to be a "Holder" hereunder; *provided* that, any subsequent transfer of the Shares by any such transferee shall also be made pursuant to, and in accordance with, all of the provisions of this Section 2 to the same extent as if each such transferee were a Holder. Each Holder shall not, directly or indirectly,

(i) pledge, encumber or create a Lien on any Shares or enter into any contract, option, commitment or other arrangement or understanding with respect to the foregoing;

(ii) grant any proxies or powers of attorney or enter into a voting agreement or other arrangement with respect to any of such Holder's Shares;

(iii) enter into, or deposit any of such Holder's Shares into, a voting trust or take any other action which would, or would reasonably be expected to, result in a diminution of the voting power represented by any of such Holder's Shares; or

(iv) commit or agree to take any of the foregoing actions.

As used in this Agreement, the term "**Expiration Date**" shall mean the earliest to occur of (i) the Effective Time, (ii) such date and time as the Business Combination Agreement shall be terminated pursuant to Article 7 thereof and (iii) upon mutual written agreement of the Parties.

(b) From the Effective Time until the earlier of (i) the Lock-Up Release Date or (ii) the valid termination of this Agreement pursuant to Section 13, each Holder hereby agrees that it shall not, directly or indirectly, Transfer any of the Shares (including, for the avoidance of doubt, the DYNS Common Stock received as result of the consummation of the Merger pursuant to the Business Combination Agreement); *provided, however*, that the foregoing shall not apply to any Transfer (A) to such Holder's officers or directors, any affiliates or family member thereof or any of their affiliates; (B) in the case of an individual, by gift to a member of one of the individual's immediate family or to a trust, the beneficiary of which is a member of the individual's immediate family, an affiliate of such person or to a charitable organization; (C) in the case of an individual, by virtue of laws of descent and distribution upon death of the individual; (D) in the case of an individual, pursuant to a qualified domestic relations order; (E) by private sales or transfers made in connection with the transactions contemplated by the Business Combination Agreement; (F) pro rata to the direct or indirect partners, members or shareholders of such Holder or any related investment funds or vehicles controlled or managed by such persons or their respective affiliates in connection with the liquidation or dissolution thereof, and (G) by virtue of such Holder's organizational documents upon liquidation or dissolution thereof; *provided*, that any transferee of any Transfer of the type set forth in clauses (A) through (G) must enter into a written agreement in form and substance reasonably satisfactory to Parent agreeing to be bound by this Agreement prior to the occurrence of such Transfer. For purposes of this Agreement, the "**Lock-Up Release Date**" means the earliest of (A) the eighteen (18) month anniversary of the Closing and (B) subsequent to the Closing, (x) if the last reported sale price of the Class A Common Stock equals or exceeds \$12.00 per share (as adjusted for stock splits, stock dividends, reorganizations, recapitalizations and the like) for any 20 trading days within any 30 consecutive trading day period commencing at least 330 days after the Closing, or (y) the date upon completion of a liquidation, merger, stock exchange, reorganization or other similar transaction that results in all of the public stockholders of Parent having the right to exchange their DYNS Common Stock for cash, securities or other property; *provided that*, upon the achievement of certain conditions set forth in Schedule 3, (a) the term of the Lock-Up Release Date set forth in Clause (A) of the prior sentence shall be reduced from eighteen (18) months to twelve (12) months, and (b) the term of the Lock-Up Release Date set forth in Clause (B) shall be reduced from 330 days to 150 days. In furtherance of the foregoing, Parent hereby agrees to (i) place a revocable stop order on all Shares subject to Section 2(b), including those which may be covered by a registration statement, and (ii) notify Parent's transfer agent in writing of such stop order and the restrictions on such Shares under Section 2(b) and direct Parent's transfer agent not to process any attempts by any Holder to Transfer any Shares except in compliance with this Section 2(b).

Notwithstanding the foregoing, to the extent any Holder is granted a release or waiver to a substantially similar lockup to those set forth in the restrictions contained in this Section 2 prior to the expiration of the Lock-Up Period, then all Holders subject to such restrictions shall be automatically granted a release or waiver from the restrictions contained in this Section 2 to the same extent, on substantially the same terms as and on a pro rata basis with, the Holder to which such release or waiver is granted.

Section 3. Certain Covenants of the Holder.

(a) Each Holder and the Company hereby agrees that, notwithstanding anything to the contrary in any such agreement, (i) each of the agreements set forth on Schedule 2 hereto shall be automatically terminated and of no further force and effect (including any provisions of any such agreement that, by its terms, survive such termination) effective as of, and subject to and conditioned upon the occurrence of, the Effective Time and (ii) upon such termination neither the Company nor any of its Affiliates shall have any further obligations or Liabilities under or with respect to each such agreement. Without limiting the above, each of the Equity Holders who are a party to the agreements set forth on Schedule 2 hereby expressly and irrevocably acknowledge and agree that all terms and conditions of the respective agreements to which they are a party to were duly observed or waived, as applicable.

(b) Each Holder hereby agrees to be bound by and subject to (i) Sections 5.3(a) (Confidentiality) and 5.4(a) (Public Announcements) of the Business Combination Agreement to the same extent as such provisions apply to the parties to the Business Combination Agreement, as if such Holder is directly party thereto, and (ii) Section 5.6(a) (Exclusive Dealing) of the Business Combination Agreement to the same extent as such provisions apply to the Company, as if the Holder is directly party thereto.

Section 4. Representations and Warranties of Holders. Each Holder hereby represents and warrants to Parent as follows:

(a) such Holder has the full power and authority to execute and deliver this Agreement and to perform such Holder's obligations hereunder;

(b) this Agreement has been duly executed and delivered by such Holder and, assuming due authorization, execution and delivered by the other Parties, constitutes a valid, legal and binding agreement with respect to such Holder, enforceable against such Holder in accordance with its terms, subject to applicable bankruptcy, insolvency, reorganization, fraudulent transfer, moratorium or similar Laws affecting creditors' rights generally and general principles of equity;

(c) if such Holder is the beneficial owner of any Shares held in trust, no consent of any beneficiary of such trust is required in connection with the execution and delivery of this Agreement and the consummation of the transactions contemplated hereby or by the Business Combination Agreement;

(d) such Holder beneficially owns the number of Shares indicated opposite such Holder's name on Schedule 1 hereto, free and clear of any Liens (other than Liens created by this Agreement, applicable securities laws, the Company's Amended and Restated Certificate of Incorporation, the Company's existing bylaws, that certain Amended and Restated Investors' Rights Agreement made as of October 22, 2020 by and among the Company and certain of its stockholders, and Permitted Liens), that certain Voting Agreement entered into as of October 22, 2020 by an among the Company and certain of its stockholders, as amended by Amendment No. 1 to the Voting Agreement, and has sole, and otherwise unrestricted, voting and investment power with respect to such Shares; none of the Shares are subject to any voting trust or other agreement, arrangement or restriction with respect to the voting of the Shares; and no Person has any right to acquire from such Holder any of the Shares indicated opposite such Holder's name on Schedule 1 hereto;

(e) such Holder agrees to promptly notify Parent in writing of any changes or updates to Schedule 1 hereto as it relates to such Holder after the date hereof;

(f) such Holder understands that, at the Effective Time, each outstanding Share shall be converted into the right to receive the Merger Consideration as set forth in the Business Combination Agreement;

(g) the execution and delivery of this Agreement by such Holder, the consummation by such Holder of the transactions contemplated hereunder and the performance by such Holder of his, her or its obligations hereunder do not and will not conflict with, or result in any violation or breach of, or default (with or without notice or lapse of time or both) under, any Contract or any judgment to which such Holder is a party or by which such Holder is bound, or any Law to which such Holder is subject or, in the event that such Holder is a corporation, company, partnership, limited liability company, joint venture, association, trust, business trust or other entity, any Governing Document of such Holder;

(h) the execution and delivery of this Agreement by such Holder, the consummation by such Holder of the transactions contemplated hereunder and the performance by such Holder of his, her or its obligations hereunder do not and will not require any consent, approval, qualification, order or authorization of, registration, declaration or filing with, or notice to, any Governmental Entity by such Holder except for applicable requirements, if any, of the Exchange Act, and except where the failure to obtain such consents, approvals, qualifications, orders or authorizations or registrations, declarations or filings, would not prevent or impair in any material respect the performance by such Holder of his, her or its obligations under this Agreement; and

(i) no investment banker, broker, finder, consultant or intermediary or other Person is entitled to any broker's, finder's, financial advisor's or other similar fee or commission based upon arrangements made by or on behalf of such Holder in connection with its entering into this Agreement.

Section 5. Remedies. Notwithstanding anything to the contrary set forth in the Business Combination Agreement, the Parties agree that irreparable damage for which monetary damages, even if available, would not be an adequate remedy, would occur in the event that the Parties do not perform their respective obligations under the provisions of this Agreement in accordance with their specific terms or otherwise breach such provisions. It is accordingly agreed

that the Parties shall be entitled to an injunction or injunctions, specific performance and other equitable relief to prevent breaches of this Agreement and to enforce specifically the terms and provisions of this Agreement, in each case, without posting a bond or undertaking and without proof of damages and this being in addition to any other remedy to which they are entitled at law or in equity. Each of the Parties agrees that it will not oppose the granting of an injunction, specific performance and other equitable relief when expressly available pursuant to the terms of this Agreement on the basis that the other Parties have an adequate remedy at law or an award of specific performance is not an appropriate remedy for any reason at law or equity.

Section 6. No Waivers. No waiver of any breach of this Agreement extended by Parent to a Holder shall be construed as a waiver of any rights or remedies of Parent with respect to any other Holder or with respect to any subsequent breach of such Holder or any other such Holder. No waiver of any provisions hereof by either Party shall be deemed a waiver of any other provisions hereof by any such Party, nor shall any such waiver be deemed a continuing waiver of any provision hereof by such Party.

Section 7. Appraisal Rights; Claims. Each Holder hereby agrees (a) not to exercise any appraisal rights or any dissenters' rights that such Holder may have (whether under applicable Law or otherwise) or could potentially have or acquire in connection with the Business Combination Agreement and the transactions contemplated by the Business Combination Agreement, including the Merger, and (b) not to commence or participate in any claim, derivative or otherwise, against the Company, Parent, Merger Sub or any of their respective Affiliates relating to the negotiation, execution or delivery of this Agreement or the Business Combination Agreement or the consummation of the Merger, including any claim (i) challenging the validity of, or seeking to enjoin the operation of, any provision of this Agreement or (ii) alleging a breach of any fiduciary duty of the Company Board in connection with this Agreement, the Business Combination Agreement or the Merger.

Section 8. Fees and Expenses. Except as otherwise provided herein or in the Business Combination Agreement, all fees and expenses incurred in connection with or related to this Agreement and the Business Combination Agreement and the transactions contemplated hereby and thereby will be paid by the party incurring such fees or expenses, whether or not such transactions are consummated.

Section 9. Trust Account Waiver. Reference is made to the final prospectus of Parent, filed with the Securities Exchange Commission (the "SEC") (File No. 333-255930) on May 27, 2021 (the "Prospectus"). The Holder acknowledges and agrees and understands that Parent has established a Trust Account containing the proceeds of IPO and from certain private placements occurring simultaneously with the IPO (including interest accrued from time to time thereon) for the benefit of Parent's Public Stockholders, and Parent may disburse monies from the Trust Account only in the express circumstances described in the Prospectus. The Holder hereby agrees that, notwithstanding anything to the contrary in this Agreement, it does not now and shall not at any time hereafter have any right, title, interest or claim of any kind in or to any monies in the Trust Account or distributions therefrom, or make any claim against the Trust Account (including any distributions therefrom), regardless of whether such claim arises based on contract, tort, equity or any other theory of legal liability.

Section 10. Notices. All notices, requests, claims, demands and other communications under this Agreement shall be in writing and shall be given (and shall be deemed to have been duly given) by delivery in person, by facsimile (having obtained electronic delivery confirmation thereof), e-mail (having obtained electronic delivery confirmation thereof), or by registered or certified mail (postage prepaid, return receipt requested) (upon receipt thereof) to the other Parties as follows:

(a) if to Parent:

Dynamics Special Purpose Corp.
2875 El Camino Real
Redwood City, CA 94061

Attention:

Email:

with copies (which shall not constitute notice) to:

Davis Polk & Wardwell LLP
450 Lexington Avenue
New York, New York 10017
Attention: Alan Denenberg
Email: alan.denenberg@davispolk.com

if to Company:

Senti Biosciences, Inc.
2 Corporate Drive, 1st Floor
South San Francisco, CA 94080
Attention: Timothy Lu, Deb Knobelman, Curt Herberts
Email: tim.lu@sentibio.com, deb.knobelman@sentibio.com,
curt.herberts@sentibio.com

with copies (which shall not constitute notice) to:

Goodwin Procter LLP
100 Northern Avenue
Boston, MA 02210
Attention: Jocelyn M. Arel
Michael R. Patrone
Facsimile: (617) 523-1231
E-mail: jarel@goodwinlaw.com
mpatrone@goodwinlaw.com

(b) if to a Holder, to the address or facsimile number set forth under such Holder's signature on the signature page hereto.

Section 11. Assignment. Neither this Agreement nor any of the rights, interests or obligations hereunder shall be assigned, in whole or in part, by operation of Law or otherwise by any of the Parties without the prior written consent of the other Parties. Subject to the preceding sentence, this Agreement shall be binding upon, inure to the benefit of and be enforceable by, the Parties and their respective successors and assigns.

Section 12. Amendment. Except as otherwise specifically set forth in this Agreement, this Agreement may not be amended except by an instrument in writing signed on behalf of each of the Parties. Except as otherwise specifically set forth in this Agreement, any amendment, supplement or modification of or to any provision of this Agreement and any waiver of any provision of this Agreement shall be effective (a) only if it is made or given in writing and signed by Parent and all of the Holders or, in the case of a waiver, by Parent and (b) only in the specific instance and for the specific purpose for which made or given. Notwithstanding anything to the contrary contained herein, any holder of Shares may become party to this Agreement by executing and delivering a counterpart signature page hereto agreeing to be bound by and subject to the terms of this Agreement as a Holder hereunder. In such event, each such person shall thereafter shall be deemed a Holder for all purposes under this Agreement.

Section 13. Termination. This Agreement shall automatically terminate, without any notice or other action by any Party, and be void *ab initio* upon the earliest to occur of (a) the Effective Time, (b) such date and time as the Business Combination Agreement shall be terminated pursuant to Article 7 thereof, and (c) upon mutual written agreement of the Parties. Upon termination of this Agreement as provided in the immediately preceding sentence, none of the Parties shall have any further obligations or Liabilities under, or with respect to, this Agreement; *provided, however*, that (i) the termination of this Agreement pursuant to the foregoing clause (b) shall not affect any Liability on the part of any Party for a Willful Breach of any covenant or agreement set forth in this Agreement prior to such termination or Fraud; (ii) the provisions of Section 2(b) (*Transfer Restrictions*), Section 3(a) (*Termination of Related Party Agreements*) and Section 7(b) (*Claims*) shall survive the termination of this Agreement pursuant to the foregoing clause (a); and (iii) the provisions of Section 5 (*Remedies*), Section 7(a) (*Appraisal Rights*), Section 8 (*Fees and Expenses*), Section 9 (*Trust Account Waiver*), Section 10 (*Notices*), Section 11 (*Assignment*), Section 12 (*Amendment*), this Section 13 (*Termination*), Section 14 (*Entire Agreement*), Section 17 (*Further Assurances*), Section 20 (*Miscellaneous*) and Section 21 (*Parties Advised by Counsel*) of this Agreement shall remain in full force and effect and survive any termination of this Agreement.

Section 14. Entire Agreement. This Agreement, the schedules hereto and the Business Combination Agreement contain the entire agreement and understanding between the Parties with respect to the subject matter hereof and thereof and supersede all prior discussions, negotiations, commitments, agreements and understandings, both written and oral, relating to such subject matter.

Section 15. No Third-Party Beneficiaries. Except as otherwise provided in this Agreement, this Agreement is for the sole benefit of the Parties and their permitted successors and assigns and nothing herein expressed or implied shall give or be construed to give to any Person, other than the Parties and such successors and assigns, any legal or equitable rights hereunder.

Section 16. Capacity as a Holder. Notwithstanding anything herein to the contrary, the Holder signs this Agreement solely in the Holder's capacity as a stockholder of the Company, and not in any other capacity and this Agreement shall not limit or otherwise affect the actions of any affiliate, employee, or designee of the Holder or any of its affiliates in his or her capacity, if applicable, as an officer or director of the Company or any other Person.

Section 17. Further Assurances. From time to time and without additional consideration, each Holder agrees that it (i) shall not take any action that would reasonably be expected to prevent, impede, interfere with or adversely affect such Holder's, the Company's and/or Parent's ability to perform its obligations under this Agreement and/or the Business Combination Agreement, except as expressly contemplated by this Agreement or the Business Combination Agreement, and (ii) shall execute and deliver, or cause to be executed and delivered, such additional transfers, assignments, endorsements, proxies, consents and other instruments, and shall take such further actions, as Parent may reasonably request for the purpose of carrying out and furthering the intent of this Agreement. In addition, each Holder that is a Company IRA Stockholder agrees to execute and deliver a counterpart of the Investor Rights Agreement, to become effective as of, and contingent upon consummation of, the Closing.

Section 18. Disclosure. Each Holder agrees to provide to Parent, the Company and their respective Representatives any information regarding such Holder or such Holder's Shares that is reasonably requested by Parent, the Company or their respective Representatives and required in order for the Company and Parent to comply with Sections 5.4(b) and 5.7 of the Business Combination Agreement. Each Holder hereby authorizes Parent and the Company to publish and disclose in any announcement or disclosure required by the SEC or Nasdaq (including the Registration Statement/Proxy Statement), the Holder's identity and ownership of the Shares and the nature of the Holder's obligations under this Agreement.

Section 19. Certain Events. Each Holder agrees (severally with respect to itself and not jointly) that this Agreement and the obligations hereunder will attach to such Holder's Shares and will be binding upon any Person to which legal or beneficial ownership of such Holder's Shares passes, whether by operation of law or otherwise, including such Holder's heirs, guardians, administrators or successors.

Section 20. Miscellaneous. The provisions of Section 8.5 (*Governing Law*), Section 8.7 (*Construction; Interpretation*), Section 8.10 (*Severability*), Section 8.11 (*Counterparts; Electronic Signatures*), Section 8.15 (*Waiver of Jury Trial*) and Section 8.16 (*Submission to Jurisdiction*) of the Business Combination Agreement shall apply to this Agreement *mutatis mutandis* as if set forth herein.

Section 21. Parties Advised by Counsel. This Agreement has been negotiated between unrelated parties who are sophisticated and knowledgeable in the matters contained in this Agreement and who have acted in their own self interest. In addition, each Party has had the opportunity to seek advice of legal counsel. This Agreement will not be interpreted or construed against any Party because that Party or any attorney or representative for that Party drafted or participated in the drafting of this Agreement.

[Signature pages follow]

IN WITNESS WHEREOF, the Parties have executed this Agreement as of the date first set forth above.

DYNAMICS SPECIAL PURPOSE CORP.

By: _____
Name: Mostafa Ronaghi
Title: Chief Executive Officer

SENTI BIOSCIENCES, INC.

By: _____
Name: Timothy Lu
Title: Chief Executive Officer

[SIGNATURE PAGE TO SUPPORT AGREEMENT]

[[HOLDER]]

[Type in name of individual Holder]

[for an entity, use the following signature block instead]

[[HOLDER]]

[Type in name of Holder entity]

By: _____

Name:

Title:]

Address for Notice:

Email for Notice:

Facsimile for Notice:

[SIGNATURE PAGE TO SUPPORT AGREEMENT]

SCHEDULE 1

Holder

Number of Shares Held

Type
Common
Preferred

Address

[SCHEDULE 1 TO SUPPORT AGREEMENT]

SCHEDULE 2

Terminated Related Party Agreements

[SCHEDULE 2 TO SUPPORT AGREEMENT]

SCHEDULE 3

Lock-Up Reduction Conditions

[SCHEDULE 3 TO SUPPORT AGREEMENT]

SUBSCRIPTION AGREEMENT

Dynamics Special Purpose Corp.
2875 El Camino Real
Redwood City, California, 94061

This Subscription Agreement (this “**Subscription Agreement**”) is being entered into in connection with the proposed business combination (the “**Transaction**”) between Dynamics Special Purpose Corp., a Delaware corporation (“**Dynamics**”), and Senti Biosciences, Inc., a Delaware corporation (the “**Company**”), pursuant to a business combination agreement to be entered into immediately following the execution of this Subscription Agreement and as of the date hereof among Dynamics, the Company, Merger Sub and the other parties thereto (the “**Transaction Agreement**”) pursuant to which, among other things, Merger Sub will merge with and into the Company, with the Company as the surviving company in the Merger as a wholly-owned subsidiary of Dynamics. Capitalized terms used but not defined in this Subscription Agreement have the meaning given to them in the Transaction Agreement.

In connection with the Transaction, Dynamics is seeking commitments from interested investors to purchase shares of Dynamics Class A common stock, par value \$0.0001 per share (the “**Shares**”), in a private placement for a purchase price of \$10.00 per share (the “**Per Share Purchase Price**”). The aggregate purchase price to be paid by the undersigned (the “**Investor**”) for the Shares for which it is subscribing (as set forth on the signature page hereto) (the “**Subscribed Shares**”) is referred to herein as the “**Subscription Amount**.” On or about the date of this Subscription Agreement, Dynamics is entering into subscription agreements (the “**Other Subscription Agreements**”) and, together with this Subscription Agreement, the “**Subscription Agreements**”) with certain other investors (the “**Other Investors**”) and, together with the Investor, the “**Investors**”), severally and not jointly, pursuant to which the Investors, severally and not jointly, have agreed to purchase on the closing date of the Transaction, inclusive of the Subscribed Shares, an aggregate amount of up to 6,680,000 Shares at the Per Share Purchase Price.

In connection therewith, and in consideration of the foregoing and the mutual representations, warranties and covenants, and subject to the conditions, set forth herein, and intending to be legally bound hereby, each of the Investor and Dynamics acknowledges and agrees as follows:

1. *Subscription.* The Investor hereby subscribes for and agrees to purchase, and Dynamics hereby agrees to issue and sell to the Investor, the Subscribed Shares on the terms and subject to the conditions provided for herein. In the event of the termination of this Subscription Agreement in accordance with the terms hereof, the Investor’s payment hereunder will be returned promptly to the Investor as set forth in Section 10 and this Subscription Agreement shall have no further force or effect.

2. *Closing*. The closing of the purchase and sale of the Subscribed Shares contemplated hereby (the “**Closing**”) is contingent upon the substantially concurrent consummation of the Transaction. The Closing shall occur on the date of, and substantially concurrently with and conditioned upon the effectiveness of, the Transaction and substantially concurrently with the Merger (as defined in the Transaction Agreement). At least five (5) Business Days before the anticipated closing date of the transactions contemplated by the Transaction Agreement (the “**Closing Date**”), Dynamics shall deliver or cause to be delivered to the Investor a written notice (the “**Closing Notice**”) specifying (i) the anticipated Closing Date, (ii) that Dynamics reasonably expects all conditions to the closing of the Transaction to be satisfied or waived (in writing by the person who has the authority to make such waiver) on the anticipated Closing Date, and (iii) wire instructions for delivery of the Subscription Amount. The Investor shall deliver to Dynamics, two (2) Business Days prior to the Closing Date specified in the Closing Notice, the Subscription Amount by wire transfer of United States dollars in immediately available funds to the account(s) specified by Dynamics in the Closing Notice, such funds to be held by Dynamics in escrow until the Closing. On the Closing Date, Dynamics shall issue the Subscribed Shares to the Investor in book entry form in the name of the Investor (or its nominee or custodian in accordance with its delivery instructions) on Dynamics’ share register, free and clear of any liens or other restrictions (other than those arising under this Subscription Agreement or applicable securities laws); *provided, however*, that Dynamics’ obligation to issue the Subscribed Shares to the Investor is contingent upon Dynamics having received the Subscription Amount in full in accordance with this Section 2 of this Subscription Agreement. Without limiting the rights of Dynamics to issue a further Closing Notice or the obligations of the Investor to subscribe for the Subscribed Shares hereunder and to deliver the Subscription Amount pursuant to the terms hereof and of such further Closing Notice, if the consummation of the Transaction does not occur within three (3) Business Days after the anticipated Closing Date specified in the Closing Notice, unless otherwise agreed to in writing by Dynamics and the Investor, Dynamics shall promptly (but in no event later than four (4) Business Days after the anticipated Closing Date specified in the Closing Notice) return the funds so delivered by the Investor to Dynamics by wire transfer of United States dollars in immediately available funds to the account specified by the Investor, and any book entries shall be deemed cancelled. As promptly as practicable after the Closing, upon request of the Investor, Dynamics shall provide the Investor with updated book-entry statements, if required, from Dynamics’ transfer agent reflecting the change in name of Dynamics to occur in connection with the Closing. For the purposes of this Subscription Agreement, “**Business Day**” shall mean any day, other than a Saturday or Sunday, on which commercial banks in New York, New York are open for the general transaction of business; *provided*, that banks shall be deemed to be open for the general transaction of business in the event of a “shelter in place” order or similar closure of physical branch locations at the direction of any Governmental Entity if such banks’ electronic funds transfer system (including for wire transfers) are open for use by customers on such day.

3. *Closing Conditions*.

(a) The obligation of the parties hereto to consummate the purchase and sale of the Subscribed Shares pursuant to this Subscription Agreement is subject to the satisfaction or waiver in writing by each party of the following conditions:

(i) no applicable court or governmental authority shall have enacted, issued, promulgated, enforced or entered any judgment, order, law, rule or regulation (whether temporary, preliminary or permanent) which is then in effect and has the effect of making consummation of the transactions contemplated hereby illegal or otherwise restraining or prohibiting consummation of the transactions contemplated hereby;

(ii) Dynamics' initial listing application with Nasdaq in connection with the transactions contemplated by the Transaction Agreement shall have been approved and, immediately following the Effective Time, Dynamics shall be able to satisfy any applicable initial and continuing listing requirements of Nasdaq, and Dynamics shall not have received any notice of non-compliance therewith that has not been cured or would not be cured at or immediately following the Effective Time, and the Subscribed Shares shall have been approved for listing on Nasdaq, subject only to official notice of issuance thereof; and

(iii) all conditions precedent to the closing of the Transaction under the Transaction Agreement, including all necessary approvals of Dynamics' shareholders and regulatory approvals, if any, as set forth in Article 6 thereof, shall have been satisfied (as determined by the parties to the Transaction Agreement and other than those conditions under the Transaction Agreement which, by their nature, are to be satisfied at the closing of the Transaction, including to the extent that any such condition is dependent upon the consummation of the purchase and sale of the Subscribed Shares pursuant to this Subscription Agreement) or waived (in writing by the person who has the authority to make such waiver).

(b) The obligation of Dynamics to consummate the issuance and sale of the Subscribed Shares pursuant to this Subscription Agreement shall be subject to the satisfaction or waiver in writing by Dynamics of the following conditions: (i) all representations and warranties of the Investor contained in this Subscription Agreement are true and correct in all material respects (other than representations and warranties that are qualified as to materiality, which representations and warranties shall be true in all respects) at and as of the Closing Date (other than those representations and warranties expressly made as of an earlier date, which shall be true and correct in all material respects (other than representations and warranties that are qualified as to materiality, which representations and warranties shall be true in all respects) as of such date), and consummation of the Closing shall constitute a reaffirmation by the Investor of each of the representations, warranties, covenants and agreements of the Investor contained in this Subscription Agreement as of the Closing Date; and (ii) the Investor shall have performed, satisfied and complied in all material respects with all covenants, agreements and conditions required by this Subscription Agreement to be performed, satisfied or complied with by it at or prior to the Closing, except where the failure of such performance, satisfaction or compliance would not, or would not reasonably be expected to, prevent, materially delay or materially impair the ability of Dynamics to consummate the Closing.

(c) The obligation of the Investor to consummate the purchase of the Subscribed Shares pursuant to this Subscription Agreement shall be subject to the satisfaction or waiver in writing by the Investor of the following conditions: (i) all representations and warranties of Dynamics contained in this Subscription Agreement shall be true and correct in all material respects (other than representations and warranties that are qualified as to materiality or Material Adverse Effect (as defined herein), which representations and warranties shall be true in all respects) at and as of the Closing Date (other than those representations and warranties expressly made as of an earlier date, which shall be true and correct in all material respects (other than representations and warranties that are qualified as to materiality or Material Adverse Effect (as defined herein), which representations and warranties shall be true in all respects) as of such date), and consummation of the Closing shall constitute a reaffirmation by Dynamics of each of the representations and warranties of Dynamics contained in this Subscription Agreement which are expressed to be given as of the Closing Date; (ii) Dynamics shall have performed, satisfied and complied in all material respects with all covenants, agreements and conditions required by this Subscription Agreement to be performed, satisfied or complied with by it at or prior to the Closing; and (iii) no amendment, modification or waiver of the Transaction Agreement (as in effect on the date hereof) shall have occurred that would reasonably be expected to materially and adversely affect the economic benefits that the Investor would reasonably expect to receive under this Subscription Agreement without having received Investor's prior written consent.

4. *Further Assurances.* At the Closing, the parties hereto shall execute and deliver such additional documents and take such additional actions as the parties may reasonably deem to be practical and necessary in order to consummate the subscription contemplated by this Subscription Agreement. In furtherance of the foregoing, the Investor shall deliver to Dynamics any information that is reasonably requested in the Closing Notice in order for Dynamics to issue the Subscribed Shares, including, without limitation, the legal name of the Investor in whose name such Subscribed Shares are to be issued and a duly executed Internal Revenue Service Form W-9 or W-8, as applicable.

5. *Dynamics Representations and Warranties.* Dynamics represents and warrants to the Investor, as of the date hereof and as of the Closing Date (unless any representation or warranty is expressed to be given as at another date or dates, in which case, Dynamics makes that representation and gives that warranty as of that date or those dates), that:

(a) Dynamics has been duly incorporated, is validly existing and is in good standing under the laws of the State of Delaware, with corporate power and authority to own, lease and operate its properties and conduct its business as presently conducted and to enter into, deliver and perform its obligations under this Subscription Agreement.

(b) As of the Closing Date, the Subscribed Shares will be duly authorized and, when issued and delivered to the Investor against full payment therefor in accordance with the terms of this Subscription Agreement, the Subscribed Shares will be validly issued, fully paid and non-assessable, free and clear of all liens or other encumbrances (other than those arising under applicable securities laws) and will not have been issued in violation of or subject to any preemptive or similar rights created under Dynamics' certificate of incorporation or bylaws (each as amended to the Closing Date), under the General Corporation Law of the State of Delaware, or by any contract to which Dynamics is a party or by which it is bound.

(c) This Subscription Agreement has been duly authorized, executed and delivered by Dynamics and, assuming that this Subscription Agreement constitutes the valid and binding agreement of the Investor, this Subscription Agreement constitutes a legal, valid and binding obligation of Dynamics, enforceable against Dynamics in accordance with its terms, except as may be limited or otherwise affected by (i) bankruptcy, insolvency, fraudulent conveyance, reorganization, moratorium or other laws relating to or affecting the rights of creditors generally, and (ii) principles of equity, whether considered at law or equity.

(d) The execution and delivery of this Subscription Agreement by Dynamics, the issuance and sale of the Subscribed Shares, the compliance by Dynamics with all of the provisions of this Subscription Agreement and the consummation of the transactions contemplated herein will not (i) conflict with or result in a breach or violation of any of the terms or provisions of, or constitute a default under, or result in the creation or imposition of any lien, charge or encumbrance upon any of the property or assets of Dynamics or any of its subsidiaries pursuant to the terms of any indenture, mortgage, deed of trust, loan agreement, lease, license or other agreement or instrument to which Dynamics or any of its subsidiaries is a party or by which Dynamics or any of its subsidiaries is bound, or to which any of the property or assets of Dynamics is subject, that would reasonably be expected, individually or in the aggregate, to have a material adverse effect on the business, financial condition or results of operations of Dynamics and its subsidiaries, taken as a whole, or materially and adversely affect (A) the ability of Dynamics to consummate the Transaction, (B) the validity of the Subscribed Shares, or (C) the legal authority of Dynamics to comply in all material respects with the terms of this Subscription Agreement (each, a "**Material Adverse Effect**"), (ii) result in any violation of the provisions of the organizational documents of Dynamics, or (iii) result in any violation of any statute or any judgment, order, rule or regulation of any court or governmental agency or body, domestic or foreign, having jurisdiction over Dynamics or any of its properties that would reasonably be expected to have a Material Adverse Effect.

(e) Dynamics is not required to obtain any consent, waiver, authorization or order of, give any notice to, or make any filing or registration with, any court or other federal, state, local or other governmental authority, self-regulatory organization (including Nasdaq) or other person in connection with the execution, delivery and performance of this Subscription Agreement (including, without limitation, the issuance of the Subscribed Shares), other than (i) notice filings required by applicable state securities laws, (ii) the filing of the Registration Statement (as defined below) pursuant to Section 7 of this Subscription Agreement, (iii) those required by Nasdaq, including with respect to obtaining stockholder approval, (iv) those required to consummate the Transaction as provided under the Transaction Agreement, (v) the filing of notification under the Hart-Scott-Rodino Antitrust Improvements Act of 1976, if applicable, and (vi) those, the failure of which to obtain, would not have, and would not be reasonably expected to have, a Material Adverse Effect. Assuming the accuracy of the Investor's representations and warranties set forth in Section 6 of this Subscription Agreement, no registration under the Securities Act or any state securities (or 'blue sky') laws is required for the offer and sale of the Subscribed Shares by Dynamics to the Investor.

(f) As of their respective dates, and except as set forth in Section 5(f) of Schedule B to this Subscription Agreement, all reports (the "**SEC Reports**") required to be filed by Dynamics with the SEC complied in all material respects with the applicable requirements of the Securities Act and the Securities Exchange Act of 1934, as amended (the "**Exchange Act**"), and the rules and regulations of the SEC promulgated thereunder, and none of the SEC Reports, when filed, contained any untrue statement of a material fact or omitted to state a material fact required to be stated therein or necessary in order to make the statements therein, in light of the circumstances under which they were made, not misleading; *except*, in each case, as set forth in any subsequent SEC Report filed or furnished with the SEC on or prior to the date hereof. Except as set forth in Section 5(f) of Schedule B to this Subscription Agreement, the financial statements of Dynamics included in the SEC Reports complied in all material respects with applicable accounting requirements and the rules and regulations of the SEC with respect thereto as in effect at the time of filing and fairly present in all material respects the financial condition of Dynamics as of and for the dates thereof and the results of operations and cash flows for the periods then ended, subject, in the case of unaudited statements, to normal, year-end audit adjustments, and such financial statements have been prepared in conformity with GAAP applied on a consistent basis during the periods involved (except as may be disclosed therein or in the notes thereto, and except that the unaudited financial statements may not contain all footnotes required by GAAP); *except*, in each case, as set forth in any subsequent SEC Report filed or furnished with the SEC on or prior to the date hereof. A copy of each SEC Report is available to the Investor via the SEC's EDGAR system. Dynamics has timely filed each report, statement, schedule, prospectus, and registration statement that it was required to file with the SEC since its initial registration of the Shares with the SEC. There are no outstanding or unresolved comments in comment letters received by Dynamics from the staff of the Division of Corporation Finance of the SEC with respect to any of the SEC Reports.

(g) Except for such matters that have not had and would not reasonably be expected to have, individually or in the aggregate, a Material Adverse Effect, there is no (i) action, suit, claim, arbitration or other proceeding, in each case by or before any governmental authority or arbitrator, pending or, to the knowledge of Dynamics, threatened against Dynamics, or (ii) judgment, decree, injunction, ruling or order of any governmental entity or arbitrator outstanding against Dynamics.

(h) As of the date hereof, the authorized capital stock of Dynamics consists of (i) 100,000,000 Shares, (ii) 10,000,000 shares of Class B common stock par value \$0.0001 per share (“**Class B Shares**”), and (iii) 1,000,000 shares of preferred stock par value \$0.0001 per share (“**Preferred Shares**”). As of the date hereof, (A) 23,715,500 Shares are issued and outstanding, (B) 5,750,000 Class B Shares are issued and outstanding, and (C) no Preferred Shares are issued and outstanding. All issued and outstanding Shares and Class B Shares have been duly authorized and validly issued, are fully paid and are non-assessable. Except as set forth above and pursuant to the Other Subscription Agreements, the Transaction Agreement and the other agreements and arrangements referred to therein or in the SEC Reports, there are no outstanding options, warrants or other rights to subscribe for, purchase or acquire from Dynamics any Shares, Class B Shares, Preferred Shares or other equity interests in Dynamics, or securities convertible into or exchangeable or exercisable for such equity interests. There are no securities or instruments issued by or to which Dynamics is a party containing anti-dilution or similar provisions that will be triggered by the issuance of (i) the Subscribed Shares pursuant to this Subscription Agreement, or (ii) the Shares to be issued pursuant to any Other Subscription Agreement. Dynamics has no subsidiaries, other than Merger Sub, and does not own, directly or indirectly, interests or investments (whether equity or debt) in any person, whether incorporated or unincorporated. There are no shareholder agreements, voting trusts or other agreements or understandings to which Dynamics is a party or by which it is bound relating to the voting of any securities of Dynamics, other than (1) as set forth in the SEC Reports, and (2) as contemplated by the Transaction Agreement.

(i) The issued and outstanding Shares are registered pursuant to Section 12(b) of the Exchange Act and are listed for trading on Nasdaq under the symbol “DYNS” (it being understood that the trading symbol will be changed in connection with the Transaction). There is no suit, action, proceeding or investigation pending or, to the knowledge of Dynamics, threatened against Dynamics by Nasdaq or the SEC, respectively, to prohibit or terminate the listing of the Shares on Nasdaq or to deregister the Shares under the Exchange Act. Dynamics has taken no action that is designed to terminate the registration of the Shares under the Exchange Act.

(j) Dynamics is in compliance with all applicable laws, except where such noncompliance would not reasonably be expected to have, individually or in the aggregate, a Material Adverse Effect. Dynamics has not received any written communication from a governmental authority that alleges that Dynamics is not in compliance with or is in default or violation of any applicable law, except where such non-compliance, default or violation would not reasonably be expected to have a Material Adverse Effect.

(k) Neither Dynamics nor any person acting on its behalf has engaged or will engage in any form of general solicitation or general advertising in connection with any offer or sale of the Subscribed Shares. The Subscribed Shares are not being offered in a manner involving a public offering under, or in a distribution in violation of, the Securities Act or any state securities laws. Neither Dynamics nor any person acting on Dynamics' behalf has, directly or indirectly, at any time within the past six (6) months, made any offer or sale of any security or solicitation of any offer to buy any security under circumstances that would cause the offering of the Subscribed Shares pursuant to this Subscription Agreement to be integrated with prior offerings by Dynamics for purposes of the Securities Act or any applicable stockholder approval provisions. Neither Dynamics nor any person acting on Dynamics' behalf has offered or sold or will offer or sell any securities, or has taken or will take any other action, which would reasonably be expected to subject the offer, issuance or sale of the Subscribed Shares, as contemplated hereby, to the registration provisions of the Securities Act.

(l) Dynamics is not under any obligation to pay any broker's fee or commission in connection with the sale of the Subscribed Shares hereunder, other than to the Placement Agents (as defined herein).

(m) The Shares are eligible for clearing through The Depository Trust Company (the "DTC"), through its Deposit/Withdrawal At Custodian (DWAC) system, and Dynamics is eligible and participating in the Direct Registration System (DRS) of DTC with respect to the Shares. Dynamics' transfer agent is a participant in DTC's Fast Automated Securities Transfer Program. The Shares are not, and have not been at any time, subject to any DTC "chill," "freeze" or similar restriction with respect to any DTC services, including the clearing of Shares through DTC.

(n) Upon consummation of the Transaction, the issued and outstanding Shares will continue to be registered pursuant to Section 12(b) of the Exchange Act and will be listed for trading on Nasdaq.

(o) Dynamics is not, and immediately after receipt of payment for the Subscribed Shares and consummation of the Transaction, will not be, an "investment company" within the meaning of the Investment Company Act of 1940, as amended.

(p) (i) There has been no action taken by Dynamics or, to the knowledge of Dynamics, any officer, director, equityholder, manager, employee, agent or representative of Dynamics, in each case, acting on behalf of Dynamics, in violation of any Anti-Corruption Laws (as herein defined), (ii) Dynamics has not been convicted of violating any Anti-Corruption Laws or subjected to any investigation by a governmental authority for violation of any Anti-Corruption Laws, (iii) Dynamics has not conducted or initiated any internal investigation or made a voluntary, directed or involuntary disclosure to any governmental authority regarding any alleged act or omission arising under or relating to any noncompliance with any Anti-Corruption Laws, and (iv) Dynamics has not received any written notice or citation from a governmental authority for any actual or potential noncompliance with any Anti-Corruption Laws. As used herein, “**Anti-Corruption Laws**” means any applicable laws relating to corruption and bribery, including the U.S. Foreign Corrupt Practices Act of 1977 (as amended), the UK Bribery Act 2010, and any similar law that prohibits bribery or corruption.

(q) Other than the Other Subscription Agreements, the Transaction Agreement and any other agreement contemplated by the Transaction Agreement, Dynamics has not entered into any side letter or similar agreement with any Other Investor or other investor in connection with such Other Investor’s or other investor’s direct or indirect investment in Dynamics. No Other Subscription Agreement includes terms and conditions that are more favorable to the Other Investor thereunder than the Investor hereunder, other than terms particular to the regulatory requirements of such Other Investor or its affiliates or related funds that are mutual funds.

(r) Neither Dynamics nor the Company, nor any of their respective subsidiaries, affiliates, directors, officers, employees, or, to their knowledge, any of their agents or representatives acting on their behalf in connection with this Subscription Agreement, is an individual or entity (“Person”) that is, or is owned or controlled by one or more Persons that are: (i) the subject of any sanctions administered or enforced by the United States Government, including OFAC and the US Department of State (collectively, “Sanctions”); or (ii) located, organized or resident in a country or territory that is, or whose government is, the subject of comprehensive territorial Sanctions (including, without limitation, Crimea, Cuba, Iran, North Korea and Syria).

6. *Investor Representations and Warranties.* The Investor represents and warrants to Dynamics that:

(a) The Investor (i) is a “qualified institutional buyer” (as defined in Rule 144A under the Securities Act) or an institutional “accredited investor” (within the meaning of Rule 501(a) under the Securities Act), in each case, satisfying the applicable requirements set forth on Schedule A, (ii) is an “institutional account” (as defined in FINRA Rule 4512(c)), (iii) is acquiring the Subscribed Shares only for its own account and not for the account of others, or if the Investor is subscribing for the Subscribed Shares as a fiduciary or agent for

one or more investor accounts, the Investor has full investment discretion with respect to each such account, and the full power and authority to make the acknowledgements, representations and agreements herein on behalf of each owner of each such account, and (iv) is not acquiring the Subscribed Shares with a view to, or for offer or sale in connection with, any distribution thereof in violation of the Securities Act (and shall provide the requested information set forth on Schedule A). The Investor is not an entity formed for the specific purpose of acquiring the Subscribed Shares, unless the newly formed entity is an entity in which all of the investors are institutional accredited investors, and is an "institutional account" as defined in FINRA Rule 4512(c).

(b) To the extent applicable, the Investor has been duly formed or incorporated, and is validly existing in good standing (to the extent the concept of good standing is applicable in such jurisdiction) under the laws of its jurisdiction of incorporation or formation and has all power (corporate or otherwise) and authority to own, lease and operate its properties and conduct its business as presently conducted and to enter into, deliver and perform its obligations under this Subscription Agreement.

(c) The Investor acknowledges and agrees that the Subscribed Shares are being offered in a transaction not involving any public offering within the meaning of the Securities Act and that the Subscribed Shares have not been registered under the Securities Act. The Investor acknowledges and agrees that the Subscribed Shares may not be offered, resold, transferred, pledged or otherwise disposed of by the Investor absent an effective registration statement under the Securities Act, except (i) to Dynamics or a subsidiary thereof, (ii) to non-U.S. persons pursuant to offers and sales that occur outside the United States within the meaning of Regulation S under the Securities Act, or (iii) pursuant to another applicable exemption from the registration requirements of the Securities Act, and in each of clauses (i) and (iii), in accordance with any applicable securities laws of the states and other jurisdictions of the United States, and that any certificates representing the Subscribed Shares shall contain a restrictive legend to such effect (provided, that such legend shall be subject to removal in accordance with Section 7(e)). The Investor acknowledges and agrees that the Subscribed Shares will be subject to transfer restrictions and, as a result of these transfer restrictions, the Investor may not be able to readily offer, resell, transfer, pledge or otherwise dispose of the Subscribed Shares and may be required to bear the financial risk of an investment in the Subscribed Shares for an indefinite period of time. The Investor acknowledges and agrees that the Subscribed Shares will not be eligible for offer, resale, transfer, pledge or disposition pursuant to Rule 144 promulgated under the Securities Act until at least one year from the date that Dynamics files a Current Report on Form 8-K following the Closing Date that includes the "Form 10" information required under applicable SEC rules and regulations. The Investor acknowledges and agrees that it has been advised to consult legal counsel prior to making any offer, resale, transfer, pledge or disposition of any of the Subscribed Shares. Nothing contained herein shall be deemed a representation or warranty by such Investor to hold the Subscribed Shares for any period of time.

(d) The Investor acknowledges and agrees that the Investor is purchasing the Subscribed Shares from Dynamics. The Investor further acknowledges that there have been no representations, warranties, covenants or agreements made to the Investor by or on behalf of Dynamics, the Company, any of their respective affiliates or any control persons, officers, directors, employees, partners, agents or representatives of any of the foregoing, or any other person or entity, expressly or by implication, other than those representations, warranties, covenants and agreements of Dynamics expressly set forth in Section 5 of this Subscription Agreement.

(e) The Investor's acquisition and holding of the Subscribed Shares will not constitute or result in a non-exempt prohibited transaction under Section 406 of the Employee Retirement Income Security Act of 1974, as amended, Section 4975 of the Internal Revenue Code of 1986, as amended, or any applicable similar law.

(f) The Investor acknowledges and agrees that the Investor has received such information as the Investor deems necessary in order to make an investment decision with respect to the Subscribed Shares, including with respect to Dynamics, the Transaction and the business of the Company. Without limiting the generality of the foregoing, the Investor acknowledges that he, she or it has had the opportunity to review the SEC Reports. The Investor acknowledges and agrees that the Investor and the Investor's professional advisor(s), if any, have had the opportunity to ask such questions, receive such answers and obtain such information as the Investor and such Investor's professional advisor(s), if any, have deemed necessary to make an investment decision with respect to the Subscribed Shares.

(g) The Investor became aware of this offering of the Subscribed Shares solely by means of direct contact between the Investor and Dynamics, the Company or a representative of Dynamics or the Company, and the Subscribed Shares were offered to the Investor solely by direct contact between the Investor and Dynamics, the Company or a representative of Dynamics or the Company. The Investor did not become aware of this offering of the Subscribed Shares, nor were the Shares offered to the Investor, by any other means. The Investor acknowledges that it has relied solely upon its independent investigation and is not relying upon, and has not relied upon, any statement, representation or warranty made by any person, firm or corporation (including, without limitation, J.P. Morgan Securities LLC, Morgan Stanley & Co. LLC and BofA Securities, Inc. (each, a "**Placement Agent**" and, together, the "**Placement Agents**"), Dynamics, the Company, any of their respective affiliates or any control persons, officers, directors, employees, partners, agents or representatives of any of the foregoing) concerning Dynamics, the Company, the Transaction Agreement, this Subscription Agreement or the transactions contemplated hereby or thereby (including the Transaction), other than the representations and warranties of Dynamics contained in Section 5 of this Subscription Agreement, in making its investment or decision to invest in Dynamics.

(h) The Investor acknowledges that it is aware that there are substantial risks incident to the purchase and ownership of the Subscribed Shares, including those set forth in Dynamics' filings with the SEC. The Investor has such knowledge and experience in financial and business matters as to be capable of evaluating the merits and risks of an investment in the Subscribed Shares, and the Investor has sought such accounting, legal and tax advice as the Investor has considered necessary to make an informed investment decision. The Investor will not look to the Placement Agents for all or part of any such loss or losses the Investor may suffer and is able to sustain a complete loss on its investment in the Subscribed Shares.

(i) Alone, or together with any professional advisor(s), the Investor has considered the risks of an investment in the Subscribed Shares and determined that the Subscribed Shares are a suitable investment for the Investor and that the Investor is able at this time and in the foreseeable future to bear the economic risk of a total loss of the Investor's investment in Dynamics. The Investor acknowledges specifically that a possibility of total loss exists.

(j) The Investor acknowledges that certain information provided to it by Dynamics was based on projections, and that such projections were prepared based on assumptions and estimates that are inherently uncertain and are subject to a wide variety of significant business, economic and competitive risks and uncertainties that could cause actual results to differ materially from those contained in the projections. The Investor acknowledges that such information and projections were prepared without the participation of the Placement Agents and that the Placement Agents assume no responsibility for independent verification of, or the accuracy or completeness of, such information or projections.

(k) The Investor acknowledges that the Placement Agents: (i) have not provided the Investor with any information or advice with respect to the Subscribed Shares, (ii) have not made and do not make any representation, express or implied, as to Dynamics, the Company, the Company's credit quality, the Subscribed Shares or the Investor's purchase of the Subscribed Shares, (iii) have not acted as the Investor's financial advisor or fiduciary in connection with the issue and purchase of Subscribed Shares, (iv) may have acquired, or during the period during which the Investor holds the Subscribed Shares, may acquire, non-public information with respect to the Company or Dynamics, which the Investor agrees need not be provided to it, and (v) may have existing or future business relationships with Dynamics and the Company (including, but not limited to, lending, depository, risk management, advisory and banking relationships) and will pursue actions and take steps that they deem necessary or appropriate to protect their interests arising therefrom without regard to the consequences for a holder of Subscribed Shares, and that certain of these actions may have material and adverse consequences for a holder of Subscribed Shares.

(l) The Investor acknowledges that it has not relied on the Placement Agents in connection with its determination as to the legality of its acquisition of the Subscribed Shares or as to the other matters referred to herein, and the Investor has not relied on any investigation that the Placement Agents, any of their affiliates or any person acting on their behalf have conducted with respect to the Subscribed Shares, Dynamics or the Company. The Investor further acknowledges that it has not relied on any information contained in any research reports or other materials prepared by the Placement Agents or any of their affiliates.

(m) The Investor acknowledges and agrees that no federal or state agency has passed upon or endorsed the merits of the offering of the Subscribed Shares or made any findings or determination as to the fairness of this investment.

(n) The execution, delivery and performance by the Investor of this Subscription Agreement are within the powers of the Investor, have been duly authorized and will not constitute or result in a breach or default under or conflict with any order, ruling or regulation of any court or other tribunal or of any governmental commission or agency, or any agreement or other undertaking, or any statute, regulation or other law to which the Investor is a party or by which the Investor is bound, except where any such breach, default, or conflict would not reasonably be expected to have a material adverse effect on the Investor's ability to consummate the transactions contemplated hereby, including the purchase of the Subscribed Shares, and, if the Investor is not an individual, will not violate any provisions of the Investor's organizational documents, including, without limitation, its incorporation or formation papers, bylaws, indenture of trust or partnership or operating agreement, as may be applicable. The signature of the Investor on this Subscription Agreement is genuine, and the signatory, if the Investor is an individual, has the legal competence and capacity to execute the same or, if the Investor is not an individual, the signatory has been duly authorized to execute the same, and assuming that this Subscription Agreement constitutes the valid and binding agreement of Dynamics, this Subscription Agreement constitutes a legal, valid and binding obligation of the Investor, enforceable against the Investor in accordance with its terms except as may be limited or otherwise affected by (i) bankruptcy, insolvency, fraudulent conveyance, reorganization, moratorium or other laws relating to or affecting the rights of creditors generally, and (ii) principles of equity, whether considered at law or equity.

(o) The Investor is not (i) a person or entity named on the List of Specially Designated Nationals and Blocked Persons administered by the U.S. Treasury Department's Office of Foreign Assets Control ("**OFAC**") or in any Executive Order issued by the President of the United States and administered by OFAC ("**OFAC List**"), or a person or entity prohibited by any OFAC sanctions program, (ii) a Designated National as defined in the Cuban Assets Control Regulations, 31 C.F.R. Part 515, or (iii) a non-U.S. shell bank or, to its knowledge, providing banking services indirectly to a non-U.S. shell bank. The Investor agrees to provide law enforcement agencies, if requested thereby, records related to this Subscription Agreement as required by applicable law; *provided*, that the Investor is permitted to do so under applicable law. If the Investor is a financial institution subject to the Bank Secrecy Act (31 U.S.C. Section 5311 et seq.), as amended by the USA PATRIOT Act of 2001, and its implementing regulations (collectively, the "**BSA/PATRIOT Act**"), the Investor maintains policies and procedures reasonably designed to comply with applicable obligations under the BSA/PATRIOT Act. To the extent required, it maintains policies and procedures reasonably designed for the screening of its investors against the OFAC sanctions programs, including the OFAC List. To the extent required by applicable law, the Investor maintains policies and procedures reasonably designed to ensure that the funds held by the Investor and used to purchase the Subscribed Shares were legally derived.

(p) The Investor acknowledges and agrees that no disclosure or offering document has been prepared by the Placement Agents in connection with the offer and sale of the Subscribed Shares.

(q) When required to deliver payment to Dynamics pursuant to Section 2 of this Subscription Agreement, the Investor will have sufficient funds to pay the Subscription Amount and consummate the purchase and sale of the Subscribed Shares pursuant to this Subscription Agreement.

(r) No broker, finder or other financial consultant has acted on behalf of the Investor in connection with this Subscription Agreement or the transactions contemplated hereby in such a way as to create any liability on Dynamics.

(s) The Investor does not have, as of the date hereof, and during the 30 day period immediately prior to the date hereof, such Investor has not entered into, any "put equivalent position" as such term is defined in Rule 16a-1 under the Exchange Act or short sale positions with respect to the securities of Dynamics.

(t) The Investor acknowledges that it is aware that J.P. Morgan Securities LLC and Morgan Stanley & Co. LLC, in addition to their role as a Placement Agent hereunder, is acting, and has acted as, respectively, capital markets advisor and financial advisor to Dynamics, including, in the case of J.P. Morgan Securities LLC, as underwriter in the initial public offering of Dynamics Class A common stock.

(u) Notwithstanding anything to the contrary set forth herein, the Investor acknowledges and agrees that, subsequent to the date of this Subscription Agreement and prior to the Closing, Dynamics may enter into one or more additional subscription agreements with other investors with terms and conditions that are not more advantageous to the investor thereunder than the terms and conditions set forth in this Subscription Agreement (other than terms particular to the regulatory requirements of such other investor or its affiliates or related funds that are mutual funds), and entry into such subscription agreements may increase the aggregate amount of Shares being subscribed for in the private placement contemplated by this Subscription Agreement. For the avoidance of doubt, such additional subscription agreements shall reflect not less than the same Per Share Purchase Price and shall, once executed, constitute Other Subscription Agreements for purposes of this Agreement, *mutatis mutandis*.

7. Registration Rights

(a) Dynamics agrees that, within 20 calendar days after the consummation of the Transaction (the "**Filing Deadline**"), it will use commercially reasonable efforts to file with the SEC (at its sole cost and expense) a registration statement registering the resale of the Subscribed Shares (the "**Registration Statement**"), and shall use its commercially reasonable efforts to have the Registration Statement declared effective as soon as practicable after the filing thereof, but no later than the earlier of (1) the 60th calendar day after the consummation of the Transaction (or 90th calendar day if the SEC notifies (orally or in writing) Dynamics that it will "review" the Registration Statement), and (2) the fifth (5th) Business Day after the date Dynamics is notified in writing by the SEC that the Registration Statement will not be "reviewed" or will not be subject to further review (the "**Effectiveness Date**"). Dynamics shall provide a draft of the Registration Statement to the Investor for review at least four (4) Business Days in advance of the date of filing the Registration Statement with the SEC (the "**Filing Date**"), and the Investor shall provide any comments on the Registration Statement to Dynamics no later than the day which is two (2) Business Days preceding the Filing Date. Dynamics agrees to cause such Registration Statement, or another shelf registration statement that includes the Subscribed Shares to be sold pursuant to this Subscription Agreement, to remain effective, except for such times as Dynamics is permitted hereunder to suspend the use of the prospectus forming part of the Registration Statement, until the earliest of (i) the date on which the Investor ceases to hold any Subscribed Shares issued pursuant to this Subscription Agreement, or (ii) the first date on which the Investor can sell all of its Subscribed Shares issued pursuant to this Subscription Agreement (or shares received in exchange therefor) under Rule 144 of the Securities Act without restriction, including, without limitation, any volume or manner of sale limitations and without the requirement for Dynamics to be in compliance with the current public information requirement under Rule 144(c)(2) (or Rule 144(i)(2), if applicable). The Investor agrees to disclose its beneficial ownership as determined in accordance with Rule 13d-3 of the Exchange Act to Dynamics upon request to assist it in making the determination described above. In no event shall the Investor be identified as a statutory underwriter in the Registration Statement unless requested by the SEC; *provided*, that if the SEC requests that the Investor be identified as a statutory underwriter in the Registration Statement, the Investor will have an opportunity to withdraw its Subscribed Shares from the Registration Statement. Notwithstanding the foregoing, if the SEC prevents Dynamics from

including any or all of the Subscribed Shares proposed to be registered under the Registration Statement due to limitations on the use of Rule 415 of the Securities Act for the resale of the Subscribed Shares or otherwise, such Registration Statement shall register for resale such number of Subscribed Shares which is equal to the maximum number of Subscribed Shares as is permitted by the SEC. In such event, the number of Shares to be registered for each selling shareholder named in the Registration Statement shall be reduced pro rata among all such selling shareholders, and as promptly as practicable after being permitted to register additional Shares under Rule 415 under the Securities Act, Dynamics shall amend the Registration Statement or file a new Registration Statement to register such additional Shares and cause such amendment or Registration Statement to become effective as promptly as practicable. Dynamics' obligations to include the Subscribed Shares for resale in the Registration Statement are contingent upon the Investor furnishing in writing to Dynamics such information regarding the Investor, the securities of Dynamics held by the Investor and the intended method of disposition of such Subscribed Shares as shall be reasonably requested by Dynamics to effect the registration of such Subscribed Shares, and the Investor shall execute such documents in connection with such registration as Dynamics may reasonably request that are customary of a selling stockholder in similar situations, provided that, the Investor shall not, in connection with the foregoing, be required to execute any lock-up or similar agreement or otherwise be subject to any contractual restriction on the ability to transfer the Subscribed Shares. For purposes of clarification, any failure by Dynamics to file the Registration Statement by the Filing Deadline or to effect such Registration Statement by the Effectiveness Date shall not otherwise relieve Dynamics of its obligations to file or effect the Registration Statement set forth in this Section 7 of this Subscription Agreement. For as long as the Registration Statement shall remain effective pursuant to this Section 7(a) of this Subscription Agreement, Dynamics will use commercially reasonable efforts to (1) qualify the Subscribed Shares for listing on the Nasdaq, and (2) update or amend the Registration Statement as necessary to include the Subscribed Shares. For as long as the Investor holds the Subscribed Shares, Dynamics will use commercially reasonable efforts to (A) make and keep public information available, as those terms are understood and defined in Rule 144, (B) file in a timely manner all reports and other documents with the SEC required under the Exchange Act, as long as Dynamics remains subject to such requirements, and (C) provide all customary and reasonable cooperation necessary, in each case, to enable the Investor to resell the Subscribed Shares pursuant to the Registration Statement or Rule 144 of the Securities Act (when Rule 144 of the Securities Act becomes available to the Investor), as applicable.

(b) Notwithstanding anything to the contrary contained herein, Dynamics may delay or postpone the effectiveness of such Registration Statement, and from time to time require the Investor not to sell under the Registration Statement or suspend the use or effectiveness of any such Registration Statement, if the board of directors of Dynamics determines in good faith that it would require Dynamics to make an Adverse Disclosure (each such circumstance, a

“**Suspension Event**”); *provided*, that, (i) Dynamics shall not so delay filing or so suspend the use of the Registration Statement on more than two occasions or for a period of more than 45 consecutive days or more than a total of 60 calendar days, in each case in any 360-day period, and (ii) Dynamics shall use commercially reasonable efforts to make such Registration Statement available for the sale by the Investor of its Subscribed Shares as soon as practicable thereafter. For purpose of this Section 7(b), “**Adverse Disclosure**” means public disclosure of any material nonpublic information which, in the good faith reasonable determination of the board of directors of Dynamics, (i) would be required to be made in any Registration Statement filed with the SEC by Dynamics so that such Registration Statement, from and after its effective date, does not contain an untrue statement of a material fact or omit to state a material fact required to be stated therein or necessary to make the statements therein not misleading; (ii) would not be required to be made at such time but for the filing, effectiveness or continued use of such Registration Statement; and (iii) Dynamics has a bona fide business purpose for not disclosing publicly and would reasonably be likely to be detrimental to Dynamics and its subsidiaries. If so directed by Dynamics, the Investor will deliver to Dynamics or, in the Investor’s sole discretion destroy, all copies of the prospectus covering the Subscribed Shares in the Investor’s possession; *provided, however*, that this obligation to deliver or destroy all copies of the prospectus covering the Subscribed Shares shall not apply (i) to the extent the Investor is required to retain a copy of such prospectus (A) in order to comply with applicable legal or regulatory requirements, or (B) in accordance with a bona fide pre-existing document retention policy, or (ii) to copies stored electronically on archival servers as a result of automatic data back-up. Dynamics shall promptly notify the Investor in writing (a) with evidence of making of such suspension decision, and (b) the date on which such suspension will begin and date on which such suspension ends.

(c) In the case of the registration, qualification, exemption or compliance effected by Dynamics pursuant to this Subscription Agreement, Dynamics shall, upon reasonable request, inform Investor as to the status of such registration, qualification, exemption and compliance. At its expense Dynamics shall advise the Investor within two (2) Business Days: (i) when a Registration Statement or any post-effective amendment thereto has become effective, (ii) of the issuance by the SEC of any stop order suspending the effectiveness of any Registration Statement or the initiation of any proceedings for such purpose, (iii) of the receipt by Dynamics of any notification with respect to the suspension of the qualification of the Subscribed Shares included therein for sale in any jurisdiction, or the initiation or threatening of any proceeding for such purpose, and (iv) subject to the provisions in this Subscription Agreement, of the occurrence of any event that requires the making of any changes in any Registration Statement or prospectus so that, as of such date, the statements therein are not misleading and do not omit to state a material fact required to be stated therein or necessary to make the statements therein (in the case of a prospectus, in light of the circumstances under which they were made) not misleading. Upon receipt of any written notice from Dynamics (which notice shall

not contain any material non-public information regarding Dynamics) of the happening of any of the foregoing or of a Suspension Event during the period that the Registration Statement is effective or, if as a result of a Suspension Event, the Registration Statement or related prospectus contains any untrue statement of a material fact or omits to state any material fact required to be stated therein or necessary to make the statements therein, in light of the circumstances under which they were made (in the case of the prospectus) not misleading, the Investor agrees that (1) it will immediately discontinue offers and sales of the Subscribed Shares under the Registration Statement (excluding, for the avoidance of doubt, sales conducted pursuant to Rule 144) until the Investor receives copies of a supplemental or amended prospectus (which Dynamics agrees to promptly prepare) that corrects the misstatement(s) or omission(s) referred to above and receives notice that any post-effective amendment has become effective (unless otherwise notified by Dynamics that it may resume such offers and sales), and (2) it will maintain the confidentiality of any information included in such written notice delivered by Dynamics except (A) for disclosure to the Investor's employees, agents and professional advisers who need to know such information and are obligated to keep it confidential, (B) for disclosures to the extent required in order to comply with reporting obligations to its limited partners who have agreed to keep such information confidential, and (C) as required by law or subpoena. Dynamics shall use its commercially reasonable efforts to obtain the withdrawal of any order suspending the effectiveness of any Registration Statement as soon as reasonably practicable. Upon the occurrence of any event contemplated in clauses (i) through (iv) above, except for such times as Dynamics is permitted hereunder to suspend, and has suspended, the use of a prospectus forming part of a Registration Statement, Dynamics shall use its commercially reasonable efforts to as soon as reasonably practicable prepare a post-effective amendment to such Registration Statement or a supplement to the related prospectus, or file any other required document so that, as thereafter delivered to purchasers of the Subscribed Shares included therein, such prospectus will not include any untrue statement of a material fact or omit to state any material fact necessary to make the statements therein, in light of the circumstances under which they were made, not misleading.

(d) For purposes of this Section 7 of this Subscription Agreement, (i) "**Subscribed Shares**" shall mean, as of any date of determination, the Subscribed Shares acquired by the Investor pursuant to this Subscription Agreement and any other equity security issued or issuable with respect to such Subscribed Shares by way of stock split, dividend, distribution, recapitalization, merger, exchange, replacement or similar event, and (ii) "**Investor**" shall include any affiliate of the undersigned Investor to which the rights under this Section 7 of this Subscription Agreement have been duly assigned.

(e) The Investor may request that Dynamics remove any restrictive legend from the book-entry position evidencing the Subscribed Shares. The Investor's request may be delivered at such time as the Subscribed Shares (i) have been or are to be sold or transferred pursuant to an effective Registration Statement, or (ii) have been or are to be sold pursuant to Rule 144 under the Securities Act, such that the Subscribed Shares held by the Investor become freely tradable, upon compliance by the Investor with the requirements of this Section 7(e). Dynamics shall cause its transfer agent to remove any restrictive legends related to the book entry account holding such Subscribed Shares and make a new, unlegended entry for such book entry Subscribed Shares without restrictive legends within two (2) trading days of any such sale or disposition, provided that Dynamics and its transfer agent have timely received from the Investor customary representations and other documentation reasonably acceptable to Dynamics and its transfer agent in connection therewith. Additionally, if restrictive legends are no longer required for the Subscribed Shares under the Securities Act, Investor may request that the restrictive legends be removed from the Subscriber Shares.

(f) Indemnification.

(i) Dynamics agrees to indemnify and hold harmless, to the extent permitted by law, the Investor, its directors, and officers, employees and agents, and each person who controls the Investor (within the meaning of Section 15 of the Securities Act or Section 20 of the Exchange Act) and each affiliate of the Investor (within the meaning of Rule 405 under the Securities Act) from and against any and all losses, claims, damages, liabilities and reasonable and documented out-of-pocket costs and expenses (including, without limitation, any reasonable attorneys' fees and expenses incurred in connection with defending or investigating any such action or claim), as incurred, that arise out of, are based upon, or are caused by any untrue or alleged untrue statement of a material fact contained in the Registration Statement, prospectus included in the Registration Statement or preliminary prospectus or any amendment thereof or supplement thereto, or any omission or alleged omission of a material fact required to be stated therein or necessary to make the statements therein, not misleading, except insofar as and to the extent, but only to the extent, the same are caused by or contained in any information or affidavit regarding the Investor furnished in writing to Dynamics by or on behalf of the Investor expressly for use therein.

(ii) The Investor agrees, severally and not jointly with any person that is a party to the Other Subscription Agreements, to indemnify and hold harmless Dynamics, its directors and officers, agents and employees, and each person who controls Dynamics (within the meaning of Section 15 of the Securities Act and Section 20 of the Exchange Act) against any losses, claims, damages, liabilities and reasonable and documented out-of-pocket costs and expenses (including, without limitation, reasonable attorneys' fees), that arise out of, are based upon, or are caused by any untrue statement of a material fact contained in the Registration Statement, or any form of prospectus or preliminary prospectus or any amendment thereof or supplement thereto, or any omission of a material fact required to be stated therein (in the case of any

prospectus, or any form of prospectus or preliminary prospectus or supplement thereto, in light of the circumstances under which they were made) or necessary to make the statements therein not misleading, but only to the extent that such untrue statement or omission is contained in any information or affidavit so furnished in writing by the Investor expressly for use therein. In no event shall the liability of the Investor be greater in amount than the dollar amount of the net proceeds received by the Investor upon the sale of the Subscribed Shares giving rise to such indemnification obligation.

(iii) Any person entitled to indemnification herein shall (A) give prompt written notice to the indemnifying party of any claim with respect to which it seeks indemnification (provided that the failure to give prompt notice shall not impair any person's right to indemnification hereunder to the extent such failure has not materially prejudiced the indemnifying party) and, (B) unless in such indemnified party's reasonable judgment and upon the advice of counsel that a conflict of interest between such indemnified and indemnifying parties exists with respect to such claim, permit such indemnifying party to assume the defense of such claim with counsel reasonably satisfactory to the indemnified party. The indemnifying party shall not be subject to any liability for any settlement made by the indemnified party without its consent (but such consent shall not be unreasonably withheld, conditioned or delayed). An indemnifying party who is not entitled to or elects not to assume the defense of a claim shall not be obligated to pay the fees and expenses of one counsel for each of the parties indemnified by such indemnifying party with respect to such claim, unless in the reasonable judgment of legal counsel to any indemnified party a conflict of interest exists between such indemnified party and any other of such indemnified parties with respect to such claim, in which case the indemnifying party shall be obligated to pay for one additional counsel with respect to the other indemnified party to which such conflict exists. No indemnifying party shall, without the consent of the indemnified party, consent to the entry of any judgment or enter into any settlement which cannot be settled in all respects by the payment of money (and such money is so paid by the indemnifying party pursuant to the terms of such settlement) or which settlement includes a statement or admission of fault and culpability on the part of such indemnified party or which does not include as an unconditional term thereof the giving by the claimant or plaintiff to such indemnified party of a release from all liability in respect of such claim or litigation.

(iv) The indemnification provided for under this Section 7(f) shall remain in full force and effect regardless of any investigation made by or on behalf of the indemnified party or any officer, director, employee, agent, affiliate or controlling person of such indemnified party and shall survive the transfer of the Subscribed Shares purchased pursuant to this Subscription Agreement.

(v) If the indemnification provided under this Section 7(f) from the indemnifying party is unavailable or insufficient to hold harmless an indemnified party in respect of any losses, claims, damages, liabilities and expenses referred to herein, then the indemnifying party, in lieu of indemnifying the indemnified party, shall contribute to the amount paid or payable by the indemnified party as a result of such losses, claims, damages, liabilities and expenses in such proportion as is appropriate to reflect the relative fault of the indemnifying party and the indemnified party, as well as any other relevant equitable considerations. The relative fault of the indemnifying party and indemnified party shall be determined by reference to, among other things, whether any action in question, including any untrue or alleged untrue statement of a material fact or omission or alleged omission to state a material fact, was made by, or relates to information supplied by, such indemnifying party or indemnified party, and the indemnifying party's and indemnified party's relative intent, knowledge, access to information and opportunity to correct or prevent such action. The amount paid or payable by a party as a result of the losses or other liabilities referred to above shall be deemed to include, subject to the limitations set forth in this Section 7(f), any legal or other fees, charges or expenses reasonably incurred by such party in connection with any investigation or proceeding. No person guilty of fraudulent misrepresentation (within the meaning of Section 11(f) of the Securities Act) shall be entitled to contribution pursuant to this Section 7(f) (v) from any person who was not guilty of such fraudulent misrepresentation. In no event shall the liability of the Investor be greater in amount than the dollar amount of the net proceeds received by the Investor upon the sale of the Subscribed Shares giving rise to such contribution obligation. Notwithstanding anything to the contrary herein, in no event will any party be liable for consequential, special, exemplary or punitive damages in connection with this Subscription Agreement.

8. *No Short Sales.* The Investor agrees that, from the date of this Subscription Agreement until the Closing, or until the earlier termination of this Subscription Agreement in accordance with Section 10 of this Subscription Agreement, none of the Investor or any person or entity acting on behalf of the Investor pursuant to any understanding with the Investor will engage in any Short Sales (as defined below) with respect to securities of Dynamics. For the purposes hereof, "**Short Sales**" shall include, without limitation, all "short sales" as defined in Rule 200 promulgated under Regulation SHO under the Exchange Act, and all types of direct and indirect stock pledges (other than pledges in the ordinary course of business as part of prime brokerage arrangements), forward sale contracts, options, puts, calls, swaps and similar arrangements (including on a total return basis), including through non-U.S. broker dealers or foreign regulated brokers. This Section 8 shall not apply to any sale (including the valid exercise of any redemption right) of securities of Dynamics (i) held by the Investor, its controlled

affiliates or any person or entity acting on behalf of the Investor or any of its controlled affiliates prior to the execution of this Subscription Agreement, or (ii) purchased by the Investor, its controlled affiliates or any person or entity acting on behalf of the Investor or any of its controlled affiliates in open market transactions after the execution of this Subscription Agreement. Further, for the avoidance of doubt, this Section 8 shall not apply to ordinary course, non-speculative hedging transactions. Notwithstanding the foregoing, (a) nothing herein shall prohibit other entities under common management with the Investor that have no knowledge of this Subscription Agreement or of the Investor's subscription for Subscribed Shares pursuant to this Subscription Agreement (including the Investor's affiliates) from entering into any Short Sales, and (b) if the Investor is a multi-managed investment vehicle, whereby separate portfolio managers manage separate portions of the Investor's assets, and the portfolio managers have no knowledge of the investment decisions made by the portfolio managers managing other portions of the Investor's assets, then, in each case, the agreement set forth above shall only apply with respect to the portion of the assets managed by the portfolio manager that made the investment decision to purchase the Subscribed Shares to be issued pursuant to this Subscription Agreement.

9. *Most Favored Nation.* Substantially concurrently with the execution of this Subscription Agreement, Dynamics is entering into Other Subscription Agreements with Other Investors in respect of subscriptions for Shares. Except as set forth on Section 9 of Schedule B hereto, if any Other Investor is afforded more favorable terms than the Investor is being afforded under the terms of this Subscription Agreement (including, without limitation, in respect of the Per Share Purchase Price), other than terms particular to the regulatory requirements of such Other Investor or its affiliates or related funds that are mutual funds, then Dynamics shall immediately inform the Investor of the more favorable terms and the Investor shall have the right to elect to receive such more favorable terms, in which case, if the Investor so elects, the parties hereto shall promptly amend this Subscription Agreement to reflect the more favorable terms. For the avoidance of doubt, the rights and obligations of any Investor or Other Investor shall be exclusive of any rights such Investor or Other Investor may have under any Non-Redemption Agreement.

10. *Termination.* This Subscription Agreement shall terminate and be void and of no further force and effect, and all rights and obligations of the parties hereunder shall terminate without any further liability on the part of any party in respect thereof, upon the earlier to occur of (a) such date and time as the Transaction Agreement is terminated in accordance with its terms, (b) upon the mutual written agreement of each of the parties hereto to terminate this Subscription Agreement, or (c) the Termination Date (as defined in the Transaction Agreement as of the date hereof) if the Closing has not occurred by the Termination Date (provided that the right to terminate this Subscription Agreement pursuant to this clause (c) shall not be available to the Investor if the Investor's breach of any of its covenants or obligations under this Subscription Agreement, or if an affiliate of the Investor is one of the Other Investors under an Other Subscription Agreement, such Other Investor's breach of any of its covenants or obligations under the Other Subscription Agreement, either individually or in the aggregate, shall have proximately caused the failure of the Closing or the Transaction to occur on or before the Termination

Date (the termination events described in the immediately preceding clauses (a) through (c) being, collectively, the “**Termination Events**”); *provided*, that nothing herein will relieve any party from liability for any willful and material breach hereof prior to the time of termination, and each party will be entitled to any remedies at law or in equity to recover losses, liabilities or damages arising from any such willful and material breach. Dynamics shall notify the Investor of the termination of the Transaction Agreement promptly after the termination of such agreement. Upon the occurrence of any Termination Event, this Subscription Agreement shall be void and of no further effect and any monies paid by the Investor to Dynamics in connection herewith shall promptly (and in any event within one (1) Business Day) following the Termination Event be returned to the Investor. No later than 9:00 a.m., New York City time, on the first (1st) Business Day following a Termination Event, Dynamics shall file with the SEC a Current Report on Form 8-K disclosing the termination of the Transaction Agreement and any other material, nonpublic information that Dynamics provides or makes available to the Investor or any of the Investor’s affiliates, attorneys, agents or representatives at any time prior to the filing of such Form 8-K with respect to the Company, the Transaction and the transactions contemplated by this Subscription Agreement, the Other Subscription Agreements and the Transaction Agreement that constitutes material, nonpublic information.

11. *Trust Account Waiver.* The Investor hereby acknowledges that Dynamics has established a trust account (the “**Trust Account**”) containing the proceeds of its initial public offering (the “**IPO**”) and from certain private placements occurring simultaneously with the IPO (including interest accrued from time to time thereon) for the benefit of Dynamics’ public stockholders and certain other parties (including the underwriters of the IPO). For and in consideration of Dynamics entering into this Subscription Agreement, and for other good and valuable consideration, the receipt and sufficiency of which are hereby acknowledged, the Investor, for an on behalf of itself and its affiliates and other related entities, hereby agrees that it does not now and shall not at any time hereafter have any right, title, interest or claim of any kind in or to any assets held in the Trust Account, and shall not make or bring any action, suit, claim or other proceeding against the Trust Account that arises as a result of, in connection with or relates in any way to this Subscription Agreement, the transactions contemplated hereby or the Subscribed Shares, and regardless of whether such action, suit, claim or other proceeding arises based on contract, tort, equity or any other theory of legal liability (any and all such actions, suits, claims or other proceedings are collectively referred to hereafter as the “**Released Claims**”). The Investor hereby irrevocably and unconditionally waives any Released Claims that it may have against the Trust Account now or in the future and will not seek recourse against the Trust Account as a result of, or arising out of, this Subscription Agreement or any other matter related to the transactions set forth herein; *provided, however*, that nothing in this Section 11 of this Subscription Agreement shall (x) be deemed to limit any of the Investor’s right, title, interest or claim to the Trust Account by virtue of Investor’s record or beneficial ownership of securities of Dynamics acquired by any means other than pursuant to this Subscription Agreement, (y) serve to limit or prohibit the Investor’s right to pursue a claim against Dynamics for legal relief against assets held outside the Trust Account, for specific performance or other equitable relief, or (z) serve to limit or prohibit any claims that the Investor may have in the future against Dynamics’ assets or funds that are not held in the Trust Account.

12. *Miscellaneous.*

(a) Neither this Subscription Agreement nor any rights that may accrue to the Investor hereunder (other than the Subscribed Shares acquired hereunder, if any) may be transferred or assigned, other than an assignment to any fund or account managed by the same investment manager as the Investor or an affiliate thereof.

(b) Dynamics may request from the Investor such additional information as Dynamics may deem necessary to register the resale of the Subscribed Shares and evaluate the eligibility of the Investor to acquire the Subscribed Shares, and the Investor shall promptly provide such information as may reasonably be requested; *provided*, that Dynamics agrees to keep any such information provided by the Investor confidential, except (i) as required by the federal securities laws, rules or regulations, and (ii) to the extent such disclosure is required by other laws, rules or regulations, at the request of the staff of the SEC or another regulatory agency or under the regulations of Nasdaq. The Investor acknowledges that Dynamics may file a copy of this Subscription Agreement with the SEC as an exhibit to a periodic report or a registration statement of Dynamics.

(c) The Investor acknowledges (i) that Dynamics and others will rely on the acknowledgments, understandings, agreements, representations and warranties contained in this Subscription Agreement, and (ii) the Placement Agents will rely on, and are expressly third-party beneficiaries of, the acknowledgments, understandings, agreements, representations and warranties set forth in Section 6, this Section 12(c), Section 12(d), Section 12(f) and Section 13.

(d) Dynamics, the Company, the Investor and the Placement Agents are each entitled to rely upon this Subscription Agreement and each is irrevocably authorized to produce this Subscription Agreement or a copy hereof to any interested party in any administrative or legal proceeding or official inquiry with respect to the matters covered hereby; *provided, however*, that the foregoing clause of this Section 12(d) of this Subscription Agreement shall not give Dynamics or the Company any rights other than those expressly set forth herein and, without limiting the generality of the foregoing and for the avoidance of doubt, in no event shall the Company be entitled to rely on any of the representations and warranties of Dynamics or the Investor set forth in this Subscription Agreement.

(e) All of the representations and warranties made by each party hereto in this Subscription Agreement shall survive the Closing until the expiration of any applicable statute of limitations. Prior to the Closing, the Investor and Dynamics agree to promptly notify the other if any of their representations and warranties set forth herein are no longer accurate in all material respects (other than representations and warranties that are qualified as to materiality or Material Adverse Effect (as defined herein), in which case, the Investor or Dynamics, as applicable, agrees to promptly notify the other if such representations and warranties are not true in all respects).

(f) This Subscription Agreement may not be modified, waived or terminated (other than pursuant to the terms of Section 10 of this Subscription Agreement) except by an instrument in writing, signed by each of the parties hereto. No failure or delay of either party in exercising any right or remedy hereunder shall operate as a waiver thereof, nor shall any single or partial exercise of any such right or remedy, or any abandonment or discontinuance of steps to enforce such right or remedy, or any course of conduct, preclude any other or further exercise thereof or the exercise of any other right or remedy. The rights and remedies of the parties hereunder are cumulative and are not exclusive of any rights or remedies that they would otherwise have hereunder. Notwithstanding anything to the contrary herein, Section 6, Section 12(c), Section 12(d), this Section 12(f) and Section 13 may not be modified, waived or terminated in a manner adverse to the Placement Agents without the written consent of the Placement Agents.

(g) This Subscription Agreement (including Schedule A hereto) constitutes the entire agreement, and supersedes all other prior agreements, understandings, undertakings, arrangements, representations and warranties, both written and oral, among the parties, with respect to the subject matter hereof. Except with respect to the persons specifically referenced herein, this Subscription Agreement shall not confer any rights or remedies upon any person other than the parties hereto, and their respective heirs, executors, administrators, successors, legal representatives and permitted assigns, and the parties hereto acknowledge that such persons so referenced are third party beneficiaries of this Subscription Agreement for the purposes of, and to the extent of, the rights granted to them, if any, pursuant to the applicable provisions.

(h) Except as otherwise provided herein, this Subscription Agreement shall be binding upon, and inure to the benefit of the parties hereto and their heirs, executors, administrators, successors, legal representatives and permitted assigns, and the agreements, representations, warranties, covenants and acknowledgments contained herein shall be deemed to be made by, and be binding upon, such heirs, executors, administrators, successors, legal representatives and permitted assigns.

(i) If any provision of this Subscription Agreement shall be adjudicated by a court of competent jurisdiction to be invalid, illegal or unenforceable, the validity, legality or enforceability of the remaining provisions of this Subscription Agreement shall not in any way be affected or impaired thereby and shall continue in full force and effect.

(j) This Subscription Agreement may be executed in one or more counterparts (including by facsimile or electronic mail or in .pdf) and by different parties in separate counterparts, with the same effect as if all parties hereto had signed the same document. All counterparts so executed and delivered shall be construed together and shall constitute one and the same agreement.

(k) The parties hereto acknowledge and agree that irreparable damage would occur in the event that any of the provisions of this Subscription Agreement were not performed in accordance with their specific terms or were otherwise breached. It is accordingly agreed that the parties may be entitled to an injunction or injunctions to prevent breaches of this Subscription Agreement, without posting a bond or undertaking and without proof of damages, to enforce specifically the terms and provisions of this Subscription Agreement, this being in addition to any other remedy to which such party is entitled at law, in equity, in contract, in tort or otherwise. The parties acknowledge and agree that this Section 12(k) of this Subscription Agreement is an integral part of the transactions contemplated hereby and without these rights, the parties hereto would not have entered into this Subscription Agreement.

(l) This Subscription Agreement shall be governed by and construed in accordance with the laws of the State of New York (regardless of the laws that might otherwise govern under applicable principles of conflicts of laws thereof) as to all matters (including any action, suit, litigation, arbitration, mediation, claim, charge, complaint, inquiry, proceeding, hearing, audit, investigation or review by or before any governmental entity related hereto), including matters of validity, construction, effect, performance and remedies.

(m) THE PARTIES HERETO IRREVOCABLY SUBMIT TO THE EXCLUSIVE JURISDICTION OF THE UNITED STATES DISTRICT COURT FOR THE SOUTHERN DISTRICT OF NEW YORK AND THE SUPREME COURT OF THE STATE OF NEW YORK SOLELY IN RESPECT OF THE INTERPRETATION AND ENFORCEMENT OF THE PROVISIONS OF THIS SUBSCRIPTION AGREEMENT AND THE DOCUMENTS REFERRED TO IN THIS SUBSCRIPTION AGREEMENT AND IN RESPECT OF THE TRANSACTIONS CONTEMPLATED HEREBY AND THEREBY, AND HEREBY WAIVE, AND AGREE NOT TO ASSERT, AS A DEFENSE IN ANY RELATED ACTION, SUIT OR PROCEEDING, THAT SUCH ACTION, SUIT OR PROCEEDING MAY NOT BE BROUGHT OR IS NOT MAINTAINABLE IN SAID COURTS OR THAT VENUE THEREOF MAY NOT BE APPROPRIATE OR THAT THIS SUBSCRIPTION AGREEMENT OR ANY SUCH DOCUMENT MAY NOT BE ENFORCED IN OR BY SUCH COURTS,

AND THE PARTIES HERETO IRREVOCABLY AGREE THAT ALL CLAIMS WITH RESPECT TO SUCH ACTION, SUIT OR PROCEEDING SHALL BE HEARD AND DETERMINED BY SUCH A NEW YORK STATE OR FEDERAL COURT. THE PARTIES HEREBY CONSENT TO AND GRANT ANY SUCH COURT JURISDICTION OVER THE PERSON OF SUCH PARTIES AND OVER THE SUBJECT MATTER OF SUCH DISPUTE AND AGREE THAT MAILING OF PROCESS OR OTHER PAPERS IN CONNECTION WITH SUCH ACTION, SUIT OR PROCEEDING IN ANY SUCH MANNER AS MAY BE PERMITTED BY LAW OR USING THE DETAILS SET FORTH IN SECTION 19 OF THIS SUBSCRIPTION AGREEMENT SHALL BE VALID AND SUFFICIENT SERVICE THEREOF. EACH PARTY ACKNOWLEDGES AND AGREES THAT ANY CONTROVERSY WHICH MAY ARISE UNDER THIS SUBSCRIPTION AGREEMENT OR THE TRANSACTIONS CONTEMPLATED HEREBY IS LIKELY TO INVOLVE COMPLICATED AND DIFFICULT ISSUES, AND THEREFORE EACH SUCH PARTY HEREBY IRREVOCABLY AND UNCONDITIONALLY WAIVES ANY RIGHT SUCH PARTY MAY HAVE TO A TRIAL BY JURY IN RESPECT OF ANY LITIGATION DIRECTLY OR INDIRECTLY ARISING OUT OF OR RELATING TO THIS SUBSCRIPTION AGREEMENT OR THE TRANSACTIONS CONTEMPLATED BY THIS SUBSCRIPTION AGREEMENT. EACH PARTY CERTIFIES AND ACKNOWLEDGES THAT (I) NO REPRESENTATIVE, AGENT OR ATTORNEY OF ANY OTHER PARTY HAS REPRESENTED, EXPRESSLY OR OTHERWISE, THAT SUCH OTHER PARTY WOULD NOT, IN THE EVENT OF LITIGATION, SEEK TO ENFORCE THE FOREGOING WAIVER; (II) SUCH PARTY UNDERSTANDS AND HAS CONSIDERED THE IMPLICATIONS OF THE FOREGOING WAIVER; (III) SUCH PARTY MAKES THE FOREGOING WAIVER VOLUNTARILY, AND (IV) SUCH PARTY HAS BEEN INDUCED TO ENTER INTO THIS SUBSCRIPTION AGREEMENT BY, AMONG OTHER THINGS, THE MUTUAL WAIVER AND CERTIFICATIONS IN THIS SECTION 12(M) OF THIS SUBSCRIPTION AGREEMENT.

13. *Non-Reliance and Exculpation.* The Investor acknowledges that it is not relying upon, and has not relied upon, any statement, representation or warranty made by any person, firm or corporation (including, without limitation, the Placement Agents, any of their affiliates or any control persons, officers, directors, employees, partners, agents or representatives of any of the foregoing), other than the statements, representations and warranties of Dynamics expressly contained in Section 5 of this Subscription Agreement, in making its investment or decision to invest in Dynamics. The Investor acknowledges and, to the maximum extent permitted by law, agrees that none of (i) any Other Investor pursuant to this Subscription Agreement or any Other Subscription Agreement (including the Other Investors' respective affiliates or any control persons, officers, directors, employees, partners, agents or representatives of any of the foregoing), (ii) the Placement Agents, their affiliates or any control persons, officers, directors, employees, partners, agents or representatives of any of the foregoing, or (iii) any party to the Transaction Agreement other than Dynamics (solely pursuant to the terms and conditions set forth

herein) or any Non-Party Affiliate, shall have any liability to the Investor pursuant to, arising out of or relating to this Subscription Agreement, the negotiation hereof or its subject matter, or the transactions contemplated hereby, including, without limitation, with respect to any action heretofore or hereafter taken or omitted to be taken by any of them in connection with the sale and purchase of the Subscribed Shares or with respect to any claim (whether in tort, contract or otherwise) for breach of this Subscription Agreement or in respect of any written or oral representations made or alleged to be made in connection herewith or as expressly provided herein, or for any actual or alleged inaccuracies, misstatements or omissions with respect to any information or materials of any kind furnished by Dynamics, the Company, the Placement Agents or any Non-Party Affiliate concerning Dynamics, the Company, the Placement Agents, any of their respective controlled affiliates, this Subscription Agreement or the transactions contemplated hereby. For purposes of this Section 13 of this Subscription Agreement, “**Non-Party Affiliate**” means former, current or future officers, directors, employees, partners, members, managers, direct or indirect equity holders or affiliates of Dynamics, the Company, the Placement Agents or any of Dynamics’, the Company’s or the Placement Agents’ controlled affiliates or any family member of the foregoing.

14. *Disclosure.* Dynamics shall, by 9:00 a.m., New York City time, on the first (1st) Business Day immediately following the date of this Subscription Agreement, issue one or more press releases and file with the SEC a Current Report on Form 8-K (collectively, the “**Disclosure Document**”) disclosing all material terms of the transactions contemplated hereby and by the Other Subscription Agreements, the Transaction and any other material, non-public information that Dynamics has provided to the Investor at any time prior to the filing of the Disclosure Document (unless Dynamics determines, in compliance with applicable laws and regulations, that any of such information is no longer material) and including as exhibits to the Disclosure Document, the form of this Subscription Agreement and the Other Subscription Agreements (in each case, without redaction). Upon the issuance of the Disclosure Document, to the actual knowledge of Dynamics, the Investor shall not be in possession of any material, non-public information received from Dynamics or any of its officers, directors, employees or agents, and the Investor shall no longer be subject to any confidentiality or similar obligations under any current agreement, whether written or oral, with Dynamics or any of its affiliates, relating to the transactions contemplated by this Subscription Agreement. No later than 9:00 a.m., New York City time, on the fourth (4th) Business Day following the Closing Date, Dynamics shall file with the SEC a Current Report on Form 8-K (the “**Super 8-K**”) disclosing the requisite Form 10 information (within the meaning of Rule 144), the consummation of the transactions contemplated by this Subscription Agreement, the Other Subscription Agreements and the Transaction Agreement (including the Transaction) and any other material, nonpublic information that Dynamics has provided or made available to the Investor or any of the Investor’s affiliates, attorneys, agents or representatives at any time prior to the filing of the Super 8-K with respect to the Company, the Transaction and the transactions contemplated by this Subscription Agreement, the Other Subscription Agreements and the Transaction Agreement that constitutes material, nonpublic information. Notwithstanding anything in this Subscription Agreement to the contrary, Dynamics shall not, without the prior written consent (including by email) of the Investor, publicly

disclose the name of the Investor or any of its affiliates or advisers, or include the name of the Investor or any of its affiliates or advisers in (i) any press release or marketing materials, or (ii) any filing with the SEC or any regulatory agency or trading market, except (1) as required by federal securities laws or other laws, in the reasonable judgment of outside counsel to Dynamics or the Sponsor, (2) at the request of the staff of the SEC or another regulatory agency, or pursuant to other routine proceedings of regulatory authorities, or (3) under the regulations of any national securities exchange on which Dynamics' securities are listed for trading (including Nasdaq), and, in each case for clauses (1) to (3), Dynamics shall be permitted to make such disclosures without the prior written consent of the Investor, provided that Dynamics, to the extent permitted by law, gives the Investor prior written notice of such disclosure under this clause (ii) and reasonably consults with the Investor regarding such disclosure; *except*, in the case of clause (ii), to the extent such announcements or other communications contain only information previously disclosed in a public statement, press release or other communication previously approved in accordance with this Section 14 of this Subscription Agreement, in which case Dynamics may publicly disclose such information without obtaining any further consent from the Investor.

15. *Several Obligations.* As applicable, for ease of administration, this single Subscription Agreement may be executed so as to enable the Investor identified on the signature page to enter into a Subscription Agreement, severally, but not jointly. The parties agree that (i) the Subscription Agreement shall be treated as if it were a separate agreement with respect to the Investor listed on the signature page and the Other Investors, as if each of the Investors had executed a separate Subscription Agreement naming only itself as subscriber, and (ii) the Investor listed on the signature page shall not have any liability under the Subscription Agreement for the obligations of any Other Investor so listed. In addition, the obligations of the Investor(s) under this Subscription Agreement are several and not joint with the obligations of any Other Investor or any other investor under the Other Subscription Agreements, and the Investor shall not be responsible in any way for the performance of the obligations of any Other Investor under this Subscription Agreement or any Other Investor or other investor under the Other Subscription Agreements. Nothing contained herein or in any Other Subscription Agreement, and no action taken by the Investor or any Other Investor or other investor pursuant hereto or thereto, shall be deemed to constitute the Investor and any Other Investors or other investors as a partnership, an association, a joint venture or any other kind of entity, or create a presumption that the Investor and any Other Investors or other investors are in any way acting in concert or as a group with respect to such obligations or the transactions contemplated by this Subscription Agreement and the Other Subscription Agreements. The Investor shall be entitled to independently protect and enforce its rights, including the rights arising out of this Subscription Agreement, and it shall not be necessary for any Other Investor to be joined as an additional party in any proceeding for such purpose.

16. *Amendments.* This Subscription Agreement may not be amended, modified or waived except by an instrument in writing, signed by each of the parties hereto.

17. *Information.* The Investor will promptly provide any information reasonably requested by Dynamics for any regulatory application or filing made or approval sought in connection with the Transaction (including filings with the SEC).

18. *Expenses.* Each party shall pay all of its own expenses in connection with the negotiation, preparation and execution of this Subscription Agreement and the consummation of the transactions contemplated herein.

19. *Notices.* All notices, requests, claims, demands and other communications hereunder shall be in writing and shall be given (and shall be deemed to have been duly given) by delivery in person, by facsimile (having obtained electronic delivery confirmation thereof), e-mail (having obtained electronic delivery confirmation thereof) or by registered or certified mail (postage prepaid, return receipt requested) (upon receipt thereof) to the other parties as follows:

(a) if to the Investor, using the contact details set forth on the signature page hereto; and

(b) if to Dynamics, to:

2875 El Camino Real
Redwood City, California, 94061
United States of America
Attention: Omid Farokhzad, Mostafa Ronaghi, Mark Afrasiabi
Email: of@dspc.bio, mr@dspc.bio, ma@dspc.bio

with a copy (which shall not constitute notice) to:

Davis Polk & Wardwell LLP
1600 El Camino Real
Menlo Park, CA 94025
United States of America
Attention: Alan Denenberg, Soren Kreider
Email: alan.denenberg@davispolk.com, w.soren.kreider@davispolk.com

or to such other address as the party to whom notice is given may have previously furnished to the other party in writing.

[SIGNATURE PAGES FOLLOW]

IN WITNESS WHEREOF, the Investor has executed or caused this Subscription Agreement to be executed by its duly authorized representative as of the date set forth below.

Name of Investor:

State/Country of Formation or Domicile:

By: _____
Name: _____
Title: _____

Name in which Subscribed Shares are to be registered (if different from the Investor): _____

Investor's EIN:

Business Address-Street:

Mailing Address-Street (if different):

City, State, Zip:

City, State Zip:

Attn: _____

Attn: _____

Telephone No.:

Telephone No.:

Facsimile No.:

Facsimile No.:

Email:

Email:

Number of Shares subscribed for:

Aggregate Subscription Amount: \$

Price Per Share: \$10.00

You must pay the Subscription Amount by wire transfer of United States dollars in immediately available funds to the account(s) specified by Dynamics in the Closing Notice.

IN WITNESS WHEREOF, Dynamics has accepted this Subscription Agreement as of the date set forth below.

DYNAMICS SPECIAL PURPOSE CORP.

By: _____
Name:
Title:

Date: _____ 2021

SCHEDULE A

ELIGIBILITY REPRESENTATIONS OF THE INVESTOR

A. QUALIFIED INSTITUTIONAL BUYER STATUS

(Please check the applicable subparagraphs):

- We are a “qualified institutional buyer” (as defined in Rule 144A under the Securities Act).

OR

B. INSTITUTIONAL ACCREDITED INVESTOR STATUS

(Please check the applicable subparagraphs):

1. We are an “accredited investor” (within the meaning of Rule 501(a) under the Securities Act or an entity in which all of the equity holders are accredited investors within the meaning of Rule 501(a) under the Securities Act), and have marked and initialed the appropriate box below indicating the provision under which we qualify as an “accredited investor.”
2. We are not a natural person.

Rule 501(a), in relevant part, states that an “accredited investor” shall mean any person who comes within any of the below listed categories, or who the issuer reasonably believes comes within any of the below listed categories, at the time of the sale of the securities to that person. The Investor has indicated, by marking and initialing the appropriate box below, the provision(s) below which apply to the Investor and under which the Investor accordingly qualifies as an “accredited investor.”

Any bank, registered broker or dealer, registered investment adviser, insurance company, registered investment company, business development company, or small business investment company;

Any plan established and maintained by a state, its political subdivisions, or any agency or instrumentality of a state or its political subdivisions for the benefit of its employees, if such plan has total assets in excess of \$5,000,000;

Any employee benefit plan, within the meaning of the Employee Retirement Income Security Act of 1974, if a bank, insurance company or registered investment adviser makes the investment decisions, or if the plan has total assets in excess of \$5,000,000;

- Any organization described in Section 501(c)(3) of the Internal Revenue Code, corporation, similar business trust, partnership or limited liability company, not formed for the specific purpose of acquiring the securities offered, with total assets in excess of \$5,000,000;
- Any trust with assets in excess of \$5,000,000, not formed to acquire the securities offered, whose purchase is directed by a sophisticated person; or
- Any entity in which all of the equity owners are “accredited investors” meeting one or more of the above tests.

AND

C. INSTITUTIONAL ACCOUNT STATUS

(Please check the applicable subparagraphs):

- We are an “institutional account” (as defined in FINRA Rule 4512(c)).

This page should be completed by the Investor and constitutes a part of the Subscription Agreement.

SCHEDULE B

Section 5(f)

With respect to the Quarterly Report on Form 10-Q for the fiscal quarter ended September 30, 2021 (the “**3Q Form 10-Q**”), which was filed on November 10, 2021, following the filing thereof, DYNS learned from its auditors and advisors that, based on discussions between the SEC and other special purpose acquisition companies and their auditors, certain revisions to the classification of redeemable Class A shares from permanent equity to temporary equity reflected in the 3Q Form 10-Q constitute, in the SEC staff’s opinion, a “material weakness” in DYNS’s internal control over financial reporting relating to accounting for complex financial instruments. In light of this material weakness, DYNS performed additional analysis and determined that the (i) audited balance sheet as of May 28, 2021 filed as Exhibit 99.1 to DYNS’s Current Report on Form 8-K filed with the SEC on June 4, 2021 (the “**Form 8-K**”), (ii) unaudited interim financial statements included in DYNS’s Quarterly Report on Form 10-Q for the quarterly period ended June 30, 2021, filed with the SEC on August 6, 2021 (the “**Q2 Form 10-Q**”), and (iii) unaudited interim financial statements included in the 3Q Form 10-Q (collectively, the “**Affected Periods**”) should no longer be relied upon due to changes required to the classification of temporary equity and permanent equity described in the 3Q Form 10-Q. On December 10, 2021, DYNS filed amendments to its 3Q Form 10-Q, 2Q Form 10-Q, and Form 8-K for the Affected Periods, reflecting the restatement of the Class A common stock subject to redemption and change to its presentation of earnings per share for the Affected Periods.

Section 9

The Company may enter into manufacturing and development joint ventures or collaborations with potential third parties, and may offer the opportunity to invest in the PIPE Financing on the same terms and conditions as other Investors to such potential third parties.

NON-REDEMPTION AGREEMENT

THIS NON-REDEMPTION AGREEMENT (this "**Agreement**"), dated as of December 19, 2021, is made by and among Dynamics Sponsor LLC, a Delaware limited liability company (the "**Sponsor**"), Dynamics Special Purpose Corp., a Delaware corporation ("**DYNS**") and the undersigned investor (the "**Investor**"). Capitalized terms used but not defined herein shall have the respective meanings ascribed to such terms in the Business Combination Agreement (as defined below).

RECITALS

WHEREAS, DYNS, Senti Biosciences, Inc., a Delaware corporation (the "**Target**") and Explore Merger Sub, Inc., a Delaware Corporation ("**Merger Sub**") entered into that certain Business Combination Agreement, dated as of the date hereof, as may be amended from time to time (the "**Business Combination Agreement**"), pursuant to which Merger Sub will merge with and into the Target, with the Target being the surviving corporation and a wholly-owned subsidiary of DYNS at Closing (the "**Merger**").

WHEREAS, as of the date hereof, the Sponsor is the holder of 5,750,000 shares of DYNS's Class B common stock which, immediately prior to the Effective Time, shall convert into an equal amount of DYNS Class A common stock (the "**Sponsor Shares**").

WHEREAS, as of the date hereof, the Investor is the beneficial owner of the number of shares of DYNS's Class A common stock set forth on the signature page hereto (together with any other shares, capital stock or any other equity interests, as applicable, of DYNS that the Investor holds of record or beneficially as of the date hereof, the "**Investor Shares**").

WHEREAS, in consideration of the Investor's commitment to, among other things, not redeem the Investor Shares, and subject to the conditions set forth herein, the Sponsor agrees to forfeit [\bullet] Sponsor Shares (the "**Forfeited Sponsor Shares**") for no additional consideration other than the commitments and undertakings of the Investor made to DYNS herein, and DYNS agrees to (x) cancel the Forfeited Sponsor Shares for no additional consideration other than the commitments and undertakings of the Investor made to DYNS herein, and (y) issue to the Investor [\bullet] shares of fully paid, non-assessable DYNS Class A common stock (the "**New Investor Shares**"), in each case, on or promptly following the consummation of the Merger at Closing.

WHEREAS, the Investor acknowledges and agrees that DYNS would not have entered into and agreed to consummate the transactions contemplated by the Business Combination Agreement without the Investor entering into this Agreement and agreeing to be bound by the agreements, covenants and obligations contained in this Agreement.

AGREEMENT

NOW, THEREFORE, in consideration of the foregoing and the mutual promises and agreements contained herein, and for other good and valuable consideration, the receipt and sufficiency of which are hereby acknowledged, and intending to be legally bound hereby, the parties hereto hereby agree as follows:

ARTICLE 1
AGREEMENTS OF THE INVESTOR

Section 1.01. The Investor hereby agrees, for the benefit of DYNS, not to redeem, or to submit a request to DYNS's transfer agent to redeem or otherwise exercise any right to redeem, any Investor Shares and to reverse and revoke any prior redemption elections made with respect to the Investor Shares.

Section 1.02. The Investor hereby agrees, for the benefit of DYNS, that neither it, nor any person or entity acting on its behalf or pursuant to any understanding with it, will (a) engage in any hedging transactions or Short Sales (as defined below) with respect to securities of DYNS which are designed to or which would (either alone or in connection with one or more events or developments (including the satisfaction or waiver of any conditions precedent)) lead to or result in a sale or disposition of the Investor Shares, even if such Investor Shares would be disposed of by a person other than the Investor, (b) offer for sale, sell (including Short Sales), transfer (including by operation of law), place a lien on, pledge, convert, assign or otherwise dispose of (including by gift, merger, tendering into any tender offer or exchange offer or otherwise) or encumber (collectively, a "**Transfer**"), or enter into any contract, option, derivative, hedging or other agreement, arrangement, undertaking or understanding (including any profit-sharing arrangement) with respect to, or consent to, a direct or indirect Transfer of, any or all of the Investor Shares, (c) deposit any of the Investor Shares into a voting trust or enter into a voting agreement or arrangement or grant any proxies or powers of attorney with respect to any or all of the Investor Shares, or (d) take any action that would have the effect of preventing or materially delaying the performance of its obligations hereunder. Notwithstanding the provisions of this Section 1.02, nothing in this Agreement shall restrict the Investor from selling or otherwise transferring any shares of DYNS Class A common stock in connection with programmatic, non-discretionary sales required due to client redemptions (and not, for the avoidance of doubt, due to active portfolio management activity) in mutual funds managed or offered by the Investor; *provided*, that if the Investor's holdings are reduced below 80% of day one value Investor Shares as a result of such redemptions, the Investor shall promptly notify the Target and DYNS. DYNS acknowledges that such mutual fund redemption activity may result in the number of Investor Shares which are subject to the covenants in this Agreement (and in particular, the covenants in Section 1.01 and Section 1.02) increasing or decreasing from time to time. For purposes of this Section 1.02, "**Short Sales**" shall include, without limitation, (i) all "short sales" as defined in Rule 200 promulgated under Regulation SHO under the Exchange Act, (ii) all types of direct and indirect stock pledges (other than pledges in the ordinary course of business as part of prime brokerage or other similar financing arrangements), forward sale contracts, options, puts, calls, swaps and similar arrangements (including on a total return basis), and (iii) sales and other transactions through non-U.S. broker dealers or foreign regulated brokers.

Section 1.03. Solely with respect to the New Investor Shares, the Investor agrees (a) to be bound by the transfer restrictions in DYNS's certificate of incorporation and bylaws, and (b) to become party to the Investor Rights Agreement as a "Non-Redemption Investor" (as defined therein).

ARTICLE 2
AGREEMENTS OF THE SPONSOR AND DYNS

Section 2.01. In consideration of the Investor's performance of its obligations described herein and upon satisfaction (or, if applicable, waiver) of the conditions set forth in Section 2.03 of this Agreement, in each case effective as of and conditioned on the consummation of the Merger, (i) the Sponsor agrees to forfeit the Forfeited Sponsor Shares, for no additional consideration other than the commitments and undertakings of the Investor made to DYNS herein, with effect on and from the consummation of the Merger, and (ii) DYNS agrees to (x) cancel the Forfeited Sponsor Shares, for no additional consideration other than the commitments and undertakings of the Investor made to DYNS herein, and cancel such Forfeited Sponsor Shares on the books and records of DYNS, and (y) issue the New Investor Shares to the Investor, in each case, promptly following the consummation of the Merger (but no later than three (3) Business Days following such date). The Investor may, no later than three (3) Business Days prior to Closing, designate in writing to DYNS any managed accounts or fund entities for which the Investor exercises investment discretion to receive the issuance of the New Investor Shares.

Section 2.02. DYNS hereby agrees that if, between the date hereof and the Closing Date, it grants any other person, in connection with such person's agreement not to redeem its or their DYNS Class A common stock, rights with respect to an issuance of DYNS Class A common stock or DYNS Class B common stock (including in connection with a corresponding transfer or forfeiture of Sponsor Shares), which rights are more favorable to such other person than the rights set forth in this Agreement in respect of the Investor, then DYNS shall grant the Investor the same rights granted to such other person.

Section 2.03. The obligations of the Sponsor and DYNS pursuant to Section 2.01 of this Agreement shall be subject to the satisfaction, or valid waiver by the Sponsor and DYNS, of the following conditions:

(a) the Investor shall have fully complied with, performed and satisfied its obligations set out in Section 1.01 and Section 1.02, and shall have performed, satisfied and complied in all material respects with all other covenants, agreements and conditions required by this Agreement to be performed, satisfied or complied with by it at or prior to the Closing;

(b) the Closing shall have occurred; and

(c) all representations and warranties of the Investor contained in this Agreement shall be true and correct in all material respects (other than representations and warranties that are qualified as to materiality, which representations and warranties shall be true and correct in all respects) at and as of the Closing Date (except for representations and warranties made as of a specific date, which shall be true and correct in all material respects (other than representations and warranties that are qualified as to materiality, which representations and warranties shall be true and correct in all respects) as of such date).

ARTICLE 3
REPRESENTATIONS AND WARRANTIES

Section 3.01. *Representations and Warranties of the Sponsor.* The Sponsor represents and warrants as of the date hereof to the Investor as follows:

(a) The Sponsor is duly organized, validly existing and in good standing under the laws of the State of Delaware, and the execution, delivery and performance of this Agreement and the consummation of the transactions contemplated hereby are within the Sponsor's limited liability company powers and have been duly authorized by all necessary limited liability company actions on the part of the Sponsor. This Agreement has been duly executed and delivered by the Sponsor and, assuming due authorization, execution and delivery by the Investor, this Agreement constitutes a legally valid and binding obligation of the Sponsor, enforceable against the Sponsor in accordance with the terms hereof (except as enforceability may be limited by bankruptcy Laws, other similar Laws affecting creditors' rights and general principles of equity affecting the availability of specific performance and other equitable remedies).

(b) The Sponsor is the record owner of all of the Forfeited Sponsor Shares.

(c) The execution and delivery of this Agreement by the Sponsor does not, and the performance by the Sponsor of its obligations hereunder will not, (i) conflict with or result in a violation of the organizational documents of the Sponsor or (ii) require any consent or approval that has not been given or other action that has not been taken by any person, in each case to the extent such consent, approval or other action would prevent, enjoin or materially delay the performance by the Sponsor of its obligations under this Agreement. The Sponsor has full right and power to enter into this Agreement.

(d) The Sponsor is not entering into the transactions contemplated by this Agreement to create actual or apparent trading activity in the DYNS Class A common stock (or any security convertible into or exchangeable for DYNS Class A common stock) or to raise or depress or otherwise manipulate the price of the DYNS Class A common stock (or any security convertible into or exchangeable for the DYNS Class A common stock) or otherwise in violation of the Exchange Act. The Sponsor has not entered into or altered, and agrees that the Sponsor will not enter into or alter, any corresponding or hedging transaction or position with respect to the DYNS Class A common stock.

Section 3.02. *Representations and Warranties of DYNs*. DYNs represents and warrants as of the date hereof to the Investor as follows:

(a) DYNs is duly incorporated, validly existing and in good standing under the laws of the State of Delaware, and the execution, delivery and performance of this Agreement and the consummation of the transactions contemplated hereby are within DYNs's corporate powers and have been duly authorized by all necessary corporate actions on the part of DYNs. This Agreement has been duly executed and delivered by DYNs and, assuming due authorization, execution and delivery by the Investor, this Agreement constitutes a legally valid and binding obligation of DYNs, enforceable against DYNs in accordance with the terms hereof (except as enforceability may be limited by bankruptcy Laws, other similar Laws affecting creditors' rights and general principles of equity affecting the availability of specific performance and other equitable remedies).

(b) The execution and delivery of this Agreement by DYNs does not, and the performance by DYNs of its obligations hereunder, including the issuance of the New Investor Shares, will not, (i) conflict with or result in a violation of the organizational documents of DYNs or (ii) require any consent or approval that has not been given or other action that has not been taken by any person, in each case to the extent such consent, approval or other action would prevent, enjoin or materially delay the performance by DYNs of its obligations under this Agreement. DYNs has full right and power to enter into this Agreement.

(c) The New Investor Shares will, as of their date of issue, (i) be duly authorized by DYNs and be validly issued, fully paid and non-assessable, (ii) not have been issued in violation of or subject to any preemptive or similar rights created under DYNs's certificate of incorporation or bylaws, under Law or otherwise, and (iii) not be subject to any Liens or any other limitations or restrictions on transferability, other than pursuant to (A) this Agreement, (B) DYNs's certificate of incorporation or bylaws, (C) the Business Combination Agreement, (D) the Investor Rights Agreement, and (E) any applicable securities laws.

(d) As of the date of this Agreement, the authorized capital stock of DYNs consists of (i) 100,000,000 shares of Class A common stock par value \$0.0001 per share ("**Class A Shares**"), (ii) 10,000,000 shares of Class B common stock par value \$0.0001 per share ("**Class B Shares**"), and (iii) 1,000,000 shares of preferred stock par value \$0.0001 per share ("**Preferred Shares**"). As of the date of this Agreement, (A) 23,715,500 Class A Shares are issued and outstanding, (B) 5,750,000 Class B Shares are issued and outstanding, and (C) no Preferred Shares are issued and outstanding. All issued and outstanding Class A Shares and Class B Shares have been duly authorized and validly issued, are fully paid and are non-assessable. Except as set forth above and pursuant to the Subscription Agreements, the non-redemption agreements entered into as of the date of this Agreement with certain other holders of Class A Shares, the Business Combination Agreement and the other agreements and arrangements referred to therein, and any report filed by DYNs with the SEC (the "**SEC Reports**"), as of the date hereof, there are no outstanding options, warrants or other rights to subscribe for, purchase or acquire from DYNs any Class A Shares, Class B Shares, Preferred Shares or other equity interests in DYNs, or securities convertible into or exchangeable or exercisable for such equity interests. There are no securities or instruments issued by or to which DYNs is a

party containing anti-dilution or similar provisions that will be triggered by the issuance of the New Investor Shares pursuant to this Agreement. As of the date hereof, DYNS has no subsidiaries, other than Merger Sub, and does not own, directly or indirectly, interests or investments (whether equity or debt) in any person, whether incorporated or unincorporated. There are no shareholder agreements, voting trusts or other agreements or understandings to which DYNS is a party or by which it is bound relating to the voting of any securities of DYNS, other than (1) as set forth in the SEC Reports, and (2) as contemplated by the Business Combination Agreement.

Section 3.03. *Representations and Warranties of The Investor.* The Investor represents and warrants as of the date hereof to the Sponsor and DYNS as follows:

(a) The Investor is duly organized, validly existing and in good standing under the laws of the jurisdiction of its formation or incorporation, and the execution, delivery and performance of this Agreement and the consummation of the transactions contemplated hereby are within the Investor's powers and have been duly authorized by all necessary actions on the part of the Investor. This Agreement has been duly executed and delivered by the Investor and, assuming due authorization, execution and delivery by the Sponsor and DYNS, this Agreement constitutes a legally valid and binding obligation of the Investor, enforceable against the Investor in accordance with the terms hereof (except as enforceability may be limited by bankruptcy Laws, other similar Laws affecting creditors' rights and general principles of equity affecting the availability of specific performance and other equitable remedies).

(b) The execution and delivery of this Agreement by the Investor does not, and the performance by the Investor of its obligations hereunder will not, (i) conflict with or result in a violation of the organizational documents of the Investor or (ii) require any consent or approval that has not been given or other action that has not been taken by any person, in each case to the extent such consent, approval or other action would prevent, enjoin or materially delay the performance by the Investor of its obligations under this Agreement.

(c) The Investor is an "accredited investor" as such term is defined in Rule 501(a)(3) of Regulation D under the Securities Act.

(d) The Investor understands that any New Investor Shares that may be issued to the Investor pursuant to this Agreement are being offered in a transaction not involving any public offering within the meaning of the Securities Act and that the New Investor Shares have not been registered under the Securities Act. The Investor understands that the New Investor Shares may not be offered, resold, transferred, pledged or otherwise disposed of by the Investor absent an effective registration statement under the Securities Act, except pursuant to an applicable exemption from the registration requirements of the Securities Act, and in accordance with any applicable securities laws of the applicable states and other jurisdictions of the United States, and that any certificates or book entry records representing the New Investor Shares shall contain a restrictive legend to such effect. The Investor acknowledges and agrees that the New Investor Shares will be subject to these securities law transfer restrictions and, as a result of these transfer

restrictions, the Investor may not be able to readily resell the New Investor Shares and may be required to bear the financial risk of an investment in the New Investor Shares for an indefinite period of time. The Investor understands that it has been advised to consult legal counsel prior to making any offer, resale, pledge or transfer of any of the New Investor Shares.

(e) In making its decision to invest in the New Investor Shares, the Investor has relied solely upon independent investigation made by the Investor and the Sponsor's and DYNS's representations, warranties and covenants contained herein. The Investor has not relied on any statements or other information provided by anyone other than the Sponsor or DYNS concerning DYNS, the Target, the Merger, the New Investor Shares or the offer of the New Investor Shares. The Investor acknowledges and agrees that the Investor has received such information as the Investor deems necessary in order to make an investment decision with respect to the New Investor Shares, including with respect to the Target, DYNS and the Merger, and made its own assessment and is satisfied concerning the relevant tax and other economic considerations relevant to the Investor's investment in the New Investor Shares. The Investor represents and agrees that the Investor and the Investor's professional advisor(s), if any, have had the full opportunity to ask such questions, receive such answers and obtain such information as the Investor and its professional advisor(s), if any, have deemed necessary to make an investment decision with respect to the New Investor Shares. Without limiting the generality of the foregoing, the Investor acknowledges that it has had an opportunity to review the SEC Reports.

(f) Investor became aware of the offering of the New Investor Shares solely by means of direct contact between the Investor, DYNS and the Sponsor or their representatives or affiliates. The Investor did not become aware of the offering of the New Investor Shares, nor were the New Investor Shares offered to the Investor, by any other means. The Investor acknowledges that New Investor Shares (i) were not offered by any form of general solicitation or general advertising and (ii) are not being offered in a manner involving a public offering under the Securities Act or any state securities laws.

(g) Investor acknowledges that it is aware that there are substantial risks incident to the ownership of the New Investor Shares. The Investor has such knowledge and experience in financial and business matters as to be capable of evaluating the merits and risks of an investment in the New Investor Shares, and the Investor has had an opportunity to seek, and has sought, such accounting, legal, business and tax advice as the Investor has considered necessary to make an informed investment decision. The Investor is not relying on any statements or representations of the Sponsor, DYNS or any of their agents for legal, tax or investment advice with respect to this Agreement or the transactions contemplated by the Agreement.

(h) The Investor has fully considered the risks of an investment in the New Investor Shares and determined that the New Investor Shares are a suitable investment for the Investor and that the Investor is able at this time and in the foreseeable future to bear the economic risk of a total loss of the Investor's investment in the New Investor Shares. The Investor acknowledges specifically that a possibility of total loss exists.

(i) The Investor understands and agrees that no federal or state agency has passed upon or endorsed the merits of the offering of the New Investor Shares or made any findings or determination as to the fairness of this investment.

(j) No broker or finder has acted on behalf of the Investor in such a way as to create any liability on the Sponsor or DYNs in connection with this Agreement.

(k) The Investor is not entering into the transactions contemplated by this Agreement to create actual or apparent trading activity in the DYNs Class A common stock (or any security convertible into or exchangeable for DYNs Class A common stock) or to raise or depress or otherwise manipulate the price of the DYNs Class A common stock (or any security convertible into or exchangeable for the DYNs Class A common stock) or otherwise in violation of the Exchange Act. The Investor has not entered into or altered, and agrees that the Investor will not enter into or alter, any corresponding or hedging transaction or position with respect to the DYNs Class A common stock.

ARTICLE 4 MISCELLANEOUS

Section 4.01. *Termination.* This Agreement and all of its provisions shall terminate and be of no further force or effect upon the earliest to occur of (a) the termination of the Business Combination Agreement in accordance with its terms, (b) the mutual written consent of the parties hereto, (c) the Termination Date (as defined in the Business Combination Agreement as of the date hereof), if the Closing has not occurred by such date, and (d) the Closing. Upon such termination of this Agreement, all obligations of the parties under this Agreement will terminate, without any liability or other obligation on the part of any party hereto to any person in respect hereof or the transactions contemplated hereby; *provided that*, notwithstanding the foregoing or anything to the contrary in this Agreement, the termination of this Agreement pursuant to Section 4.01(a) shall not affect any liability on the part of any party for an intentional breach of this Agreement. This Article 4 shall survive the termination of this Agreement.

Section 4.02. *Trust Account Waiver.* The Investor acknowledges that DYNs has established a trust account (the “**Trust Account**”) containing the proceeds of its initial public offering (“**IPO**”) and certain proceeds of the private placement (including interest accrued from time to time thereon) for the benefit of its public stockholders and certain other parties (including the underwriters of the IPO). For good and valuable consideration, the receipt and sufficiency of which are hereby acknowledged, the Investor hereby agrees (on its own behalf and on behalf of its related parties) that it does not now and shall not at any time hereafter have any right, title, interest or claim of any kind in or to any assets held in the Trust Account, and it shall not make any claim against the Trust Account, regardless of whether such claim arises as a result of, in connection with or relating in any way to this Agreement or any other matter, and regardless of whether such claim arises based on contract, tort, equity or any other theory of legal liability (any and all such claims are collectively referred to hereafter as the “**Released Claims**”); *provided that* the Released Claims shall not include any rights or claims of the Investor or any of its related parties as a shareholder of DYNs to the extent related to or arising from any shares of

capital stock of DYNS other than the Investor Shares. The Investor hereby irrevocably waives (on its own behalf and on behalf of its related parties) any Released Claims that it may have against the Trust Account now or in the future as a result of, or arising out of, this Agreement and will not seek recourse against the Trust Account with respect to the Released Claims.

Section 4.03. *Public Disclosure.* DYNS shall, by 9:00 a.m., New York City time, on the first (1st) Business Day immediately following the date of this Agreement, file with the SEC a Current Report on Form 8-K (the “**Disclosure Document**”) disclosing all material terms of the transactions contemplated hereby and by the Merger and any other material, nonpublic information that DYNS or the Sponsor has provided to the Investor at any time prior to the filing of the Disclosure Document. Notwithstanding anything in this Agreement to the contrary, the Investor agrees that DYNS shall have the right to publicly disclose the name of the Investor, the Investor’s beneficial ownership of the New Investor Shares and the nature of the Investor’s commitments, arrangements and understandings under and relating to this Agreement in any Form 8-K filed by DYNS with the SEC in connection with the execution and delivery of this Agreement, and any registration statement filed or amended on or after the date of this Agreement, to the extent such disclosure is required by law; *provided* that, prior to making any such required public disclosure, DYNS shall use commercially reasonable efforts to (a) provide the Investor with three (3) Business Days to review the portion of the public disclosure that refers directly to the Investor’s commitment pursuant to this Agreement, and (b) incorporate any reasonable comments received from the Investor or its representatives within such three (3) Business Day period as to such public disclosures referring directly to the Investor’s commitment pursuant to this Agreement (it being understood, however, that with respect to the initial public disclosure as to the existence of this Agreement, such three (3) Business Day period may be reduced by DYNS to a one (1) Business Day period). Notwithstanding anything in this Agreement to the contrary, neither DYNS nor Sponsor shall publicly disclose or include the name of the Investor, its investment adviser or any of their respective affiliates in any press release or other marketing materials without the prior written consent of the Investor. The Investor shall promptly provide any information reasonably requested by DYNS for any regulatory application or filing made or approval sought in connection with the Merger (including filings with the SEC).

Section 4.04. *Governing Law.* This Agreement, the rights and duties of the parties hereto, and any disputes (whether in contract, tort or statute) arising out of, under or in connection with this Agreement will be governed by and construed and enforced in accordance with the Laws of the State of Delaware, without giving effect to its principles or rules of conflict of laws to the extent such principles or rules would require or permit the application of the laws of another jurisdiction. The parties irrevocably and unconditionally submit to the exclusive jurisdiction of the United States District Court for the District of Delaware or, if such court does not have jurisdiction, the Delaware state courts located in Wilmington, Delaware, in any action arising out of or relating to this Agreement. The parties irrevocably agree that all such claims shall be heard and determined in such a Delaware federal or state court, and that such jurisdiction of such courts with respect thereto will be exclusive. Each party hereby waives, and agrees not to assert, as a defense in any action, suit or proceeding arising out of or relating to this

Agreement that it is not subject to such jurisdiction, or that such action, suit or proceeding may not be brought or is not maintainable in such courts or that the venue thereof may not be appropriate or that this Agreement may not be enforced in or by such courts. The parties hereby consent to and grant any such court jurisdiction over the person of such parties and over the subject matter of any such dispute and agree that mailing of process or other papers in connection with any such action, suit or proceeding in the manner provided in Section 4.11 or in such other manner as may be permitted by law, will be valid and sufficient service thereof.

Section 4.05. *Waiver of Jury Trial.* To the extent not prohibited by applicable law that cannot be waived, each of the parties hereto irrevocably waives any right it may have to trial by jury in respect of any litigation based on, arising out of, under or in connection with this Agreement or any course of conduct, course of dealing, verbal or written statement or action of any party hereto or thereto, in each case, whether now existing or hereafter arising, and whether in contract, tort, statute, equity or otherwise. Each party hereby further agrees and consents that any such litigation shall be decided by court trial without a jury and that the parties to this Agreement may file a copy of this Agreement with any court as written evidence of the consent of the parties to the waiver of their right to trial by jury.

Section 4.06. *Form W-9 or W-8.* The Investor shall, on or prior to the Closing, execute and deliver to DYNS a completed IRS Form W-9 or Form W-8, as applicable.

Section 4.07. *Assignment.* This Agreement and all of the provisions hereof will be binding upon and inure to the benefit of the parties hereto and their respective heirs, successors and permitted assigns. Neither this Agreement nor any of the rights, interests or obligations hereunder will be assigned (including by operation of law) without the prior written consent of the non-assigning parties hereto.

Section 4.08. *Specific Performance.* The parties agree that irreparable damage may occur in the event that any of the provisions of this Agreement are not performed in accordance with their specific terms or are otherwise breached. It is accordingly agreed that monetary damages may not be an adequate remedy for such breach and the non-breaching party shall be entitled to seek injunctive relief, in addition to any other remedy that such party may have in law or in equity, and to enforce specifically the terms and provisions of this Agreement in the chancery court or any other state or federal court within the State of Delaware.

Section 4.09. *Amendment.* This Agreement may not be amended, changed, supplemented, waived or otherwise modified, except upon the execution and delivery of a written agreement executed by the parties hereto.

Section 4.10. *Severability.* If any provision of this Agreement is held invalid or unenforceable by any court of competent jurisdiction, the other provisions of this Agreement will remain in full force and effect. Any provision of this Agreement held invalid or unenforceable only in part or degree will remain in full force and effect to the extent not held invalid or unenforceable.

Section 4.11. *Notices*. All notices, consents, waivers and other communications under this Agreement must be in writing and will be deemed to have been duly given (a) if personally delivered, on the date of delivery; (b) if delivered by express courier service of national standing for next day delivery (with charges prepaid), on the Business Day following the date of delivery to such courier service; (c) if delivered by telecopy (with confirmation of delivery), on the date of transmission if on a Business Day before 5:00 p.m. local time of the recipient party (otherwise on the next succeeding Business Day); (d) if delivered by electronic mail, on the date of transmission if on a Business Day before 5:00 p.m. local time of the business address of the recipient party (otherwise on the next succeeding Business Day); and (e) if deposited in the United States mail, first-class postage prepaid, on the date of delivery, in each case to the appropriate addresses set forth below (or to such other addresses as a party may designate by notice to the other parties in accordance with this Section 4.11):

If to the Sponsor or DYNS:

2875 El Camino Real
Redwood City, California, 94061
United States of America Attention: Omid Farokhzad, Mostafa Ronaghi, Mark Afrasiabi
Email: of@dspc.bio, mr@dspc.bio, ma@dspc.bio

in each case, with a copy (which shall not constitute notice) to:

Davis Polk & Wardwell LLP 1600 El Camino Real
Menlo Park, CA 94025
United States Attention: Alan Denenberg, Soren Kreider
Email: alan.denenberg@davispolk.com, w.soren.kreider@davispolk.com

If to the Investor: At the address set forth on the Investor's signature page.

Section 4.12. *Counterparts*. This Agreement may be executed in two or more counterparts (any of which may be delivered by electronic transmission), each of which shall constitute an original, and all of which taken together shall constitute one and the same instrument, and shall include images of manually executed signatures transmitted by electronic format (including, without limitation, "pdf", "tif" or "jpg") and other electronic signatures (including, without limitation, DocuSign and AdobeSign). The use of electronic signatures and electronic records (including, without limitation, any contract or other record created, generated, sent, communicated, received, or stored by electronic means) shall be of the same legal effect, validity and enforceability as a manually executed signature or use of a paper-based record-keeping system to the fullest extent permitted by applicable law.

Section 4.13. *Entire Agreement*. This Agreement and the agreements referenced herein constitute the entire agreement and understanding of the parties hereto in respect of the subject matter hereof and supersede all prior understandings, agreements or representations by or among the parties hereto to the extent that they relate in any way to the subject matter hereof.

[*Signature Page Follows*]

IN WITNESS WHEREOF, the parties hereto have each caused this Non-Redemption Agreement to be duly executed on their behalf as of the date first written above.

SPONSOR

DYNAMICS SPONSOR LLC

By: _____
Name:
Title:

DYNS

DYNAMICS SPECIAL PURPOSE CORP.

By: _____
Name:
Title:

[Signature Page to Non-Redemption Agreement]

INVESTOR

[•]

By: _____

Name:

Title:

Shares of DYNS Class A common stock: [•]

Investor address:

[Address]

Attention: [•]

Email: [•]

in each case, with a copy (which shall not constitute notice)
to:

[Name]

[Address]

Attention: [•]

Email: [•]

[Signature Page to Non-Redemption Agreement]



Senti Bio and Dynamics Special Purpose Corp. Announce Business Combination Agreement to Create Publicly Listed Company Pioneering Gene Circuit-Engineered Cell and Gene Therapies

- Business combination with Dynamics Special Purpose Corp. (Nasdaq: DYNs) is expected to provide more than \$296 million in gross proceeds, over \$153 million of which is fully committed in a common stock Private Investment in Public Equity ("PIPE") financing and from non-redemption agreements -
 - Over \$86 million in non-redemption agreements committed from existing Dynamics investors including funds managed by ARK Investment Management LLC, funds and accounts managed by Counterpoint Global (Morgan Stanley Investment Management), Invus, and T. Rowe Price funds -
 - Over \$66 million in a PIPE financing committed from institutional investors including 8VC, Amgen Ventures, funds and accounts managed by Counterpoint Global (Morgan Stanley Investment Management), Invus, LifeForce Capital, NEA, Parker Institute for Cancer Immunotherapy, and T. Rowe Price funds -
- Senti Bio uses its proprietary Gene Circuit technology platform to program sense-compute-respond capabilities into cell and gene therapies, with the potential to enhance efficacy, specificity and durability against a broad range of diseases that current therapies are presently unable to address -
 - IND filings for lead product candidates SENTI-202 and SENTI-301 anticipated in 2023 -
 - Merger expected to be completed during 2Q 2022; combined company expected to be listed on the Nasdaq Capital Market -
 - Joint investor recorded presentation to discuss the proposed transaction available today, December 20, at 9:00 a.m.ET -

SOUTH SAN FRANCISCO, Calif., December 20, 2021 — Senti Biosciences, Inc. ("Senti Bio"), a leading Gene Circuit company, and Dynamics Special Purpose Corp. (Nasdaq: DYNs) ("Dynamics"), a special purpose acquisition company (SPAC) led by Omid Farokhzad, MD, Executive Chair of the Board of Directors, and Mostafa Ronaghi, PhD, Chief Executive Officer, today announced they have entered into a definitive business combination agreement to create a public company focused on Gene Circuit-engineered cell and gene therapies. Upon closing of the transaction, the combined company will be named Senti Biosciences, Inc. ("the Company") and will be led by Tim Lu, MD, PhD, Chief Executive Officer and Co-Founder of Senti Bio. The Company plans to list its common stock on the Nasdaq Capital Market. Dr. Farokhzad, who is currently serving as CEO and Chair of Seer, and David Epstein, Dynamics board member and former CEO of Novartis Pharmaceuticals, will be joining the Senti Bio Board of Directors upon closing of the transaction.

Senti Bio uses its Gene Circuit platform to program cell and gene therapies with potentially enhanced capabilities. Gene Circuits, which are created via synthetic biology and encoded as novel and proprietary combinations of DNA sequences, enable cells to sense inputs, compute decisions with biological logic, and respond to disease environments.

“Humans have always sought medicines that can treat illnesses with more precision, efficacy, and safety. However, existing drugs are still unable to match the complexity of many diseases, such as cancer and beyond. With recent advances in synthetic biology, computation, and massive biological data generation, I believe that we have a unique opportunity to engineer intelligent cell and gene therapies that directly tackle the heterogeneity and dynamic nature of disease, which have the potential to fundamentally transform our therapeutic arsenal,” said Dr. Lu. “We’re tremendously grateful for the strong support from our new and current world-class investors and from the experienced entrepreneurs, executives, and scientists at Dynamics. This fuel will amplify our team’s vision and efforts to drive Gene Circuit-engineered cell and gene therapies to patients.”

“Dynamics is looking forward to partnering with Senti to power the next generation of disruptive cell and gene therapies,” said Dr. Farokhzad. “The foundational technology of Senti—engineering Gene Circuits with programmable computer-like logic in cells—has game-changing implications for treating a variety of cancers, as well as potential applications beyond oncology. We believe that Senti’s pipeline of product candidates offers the potential to greatly enhance cancer therapy for both solid and liquid tumors, while reducing well-known limitations of current therapies. The Dynamics team, board, and advisors are thrilled to work with the Senti team as they define the future of potentially life-changing therapeutics for patients.”

Senti Bio Pipeline and Collaborations

Senti Bio’s internal therapeutic pipeline is focused on allogeneic chimeric antigen receptor natural killer (CAR-NK) cell therapies for cancer. The Company’s lead development candidates include SENTI-202 for acute myeloid leukemia (AML) and SENTI-301 for hepatocellular carcinoma (HCC); Senti Bio anticipates filing Investigational New Drug (IND) applications in 2023 for both candidates.

- SENTI-202 is designed to prevent the killing of healthy cells by leveraging a NOT logic gate, while concurrently targeting two tumor-associated antigens for enhanced AML killing by leveraging an OR logic gate, thus overcoming the limitations of other cell therapy approaches to treating AML
- SENTI-301 is designed to target an HCC-specific antigen while leveraging multi-armed, controlled cytokine release for enhanced anti-cancer activity, thus overcoming the limitations of other cell therapy approaches to treating HCC

Senti Bio has established collaborations with biopharmaceutical companies that demonstrate the broad potential of Gene Circuits in other therapeutic areas and treatment modalities.

- Spark Therapeutics, a member of the Roche Group (SIX: RO, ROG; OTCQX: RHHBY), and Senti Bio are developing next-generation gene therapies with Gene Circuits that have the potential to improve precise targeting of the central nervous system, eye, and/or liver
- BlueRock Therapeutics, a wholly-owned and independently operated subsidiary of Bayer AG, and Senti Bio are developing Gene Circuit-engineered cell therapies for a potentially broad array of therapeutic areas within the field of regenerative medicine

Planned Milestones and Uses of Proceeds

Proceeds from the PIPE and merger transaction are expected to provide Senti Bio with capital to further develop its Gene Circuit technologies and therapeutic pipeline, including:

- Filing an IND, anticipated in 2023, for SENTI-202, a logic-gated allogeneic CAR-NK cell therapy being designed to target and eliminate AML cells while sparing the healthy bone marrow;
- Filing an IND, anticipated in 2023, for SENTI-301, a multi-armed allogeneic CAR-NK cell therapy being developed for the treatment of HCC;

- Continuing to expand the breadth of Senti Bio's Gene Circuit technologies across multiple diseases and modalities to uniquely enable therapeutics previously not possible, including advancing its gene circuit platform with additional programs, such as SENTI-401, a logic-gated allogeneic CAR-NK cell therapy that is being designed to more precisely target and eliminate colorectal cancer, or CRC, cells while sparing healthy cells elsewhere in the body; and
- Building out and operating clinical-scale cGMP manufacturing capabilities for allogeneic CAR-NK cell therapies.

Summary of Transaction

The transaction values the combined company at a pro forma equity value of \$601 million, assuming a \$10.00 per share price and no shareholder redemptions. As a result of the transaction, the combined company is expected to have more than \$296 million in gross proceeds from a combination of approximately \$230.0 million in cash held in Dynamics' trust account (assuming no Dynamics shareholders exercise their redemption rights at closing) and more than \$66 million, at \$10.00 per share, from a fully committed PIPE.

Existing Dynamics shareholders, including funds managed by ARK Investment Management LLC, funds and accounts managed by Counterpoint Global (Morgan Stanley Investment Management), Invus, funds and accounts advised by T. Rowe Price Associates, Inc., have, in the aggregate, committed not to redeem over \$86 million of Dynamics' publicly traded shares in exchange for receiving approximately 965,000 newly issued shares of common stock, attributable to an equal number of shares currently owned by Dynamics Sponsor LLC, the sponsor of Dynamics, that will be contemporaneously surrendered to the combined company.

The PIPE includes participation from healthcare and technology investors, including 8VC, Amgen Ventures, funds and accounts managed by Counterpoint Global (Morgan Stanley Investment Management), Invus, LifeForce Capital, NEA, Parker Institute for Cancer Immunotherapy, funds and accounts advised by T. Rowe Price Associates, Inc., and others.

All existing Senti Bio equity holders will roll the entirety of their equity holdings into the combined company and are expected to hold approximately 40% of the issued and outstanding equity of the combined company immediately following the closing (assuming no Dynamics shareholders exercise their redemption rights at closing). Certain existing Senti Bio equity holders and Dynamics Sponsor LLC will be subject to a twelve month lock-up, subject to certain customary exceptions. Certain existing Senti Bio equity holders will be subject to an eighteen month lock-up, subject to certain additional exceptions that may reduce it to twelve months.

The transaction, which has been approved by each of Dynamics' Board of Directors and Senti Bio's Board of Directors, is expected to be completed in the second quarter of 2022, subject to approval by Dynamics' and Senti Bio's shareholders and satisfaction, or the waiver of, customary closing conditions identified in the business combination agreement.

J.P. Morgan is acting as lead capital markets advisor to Dynamics and co-placement agent for the PIPE. Morgan Stanley & Co. LLC is acting as financial advisor to Dynamics and co-placement agent to Dynamics for the PIPE. BofA Securities is acting as exclusive financial advisor to Senti Bio and as co-placement agent for the PIPE.

Davis Polk & Wardwell LLP is serving as legal advisor to Dynamics. Goodwin Procter LLP is serving as legal advisor to Senti Bio, and Latham & Watkins LLP is serving as legal advisor to J.P. Morgan, Morgan Stanley & Co. LLC and BofA Securities in their role as placement agents.



A prerecorded presentation and associated materials will be available on Deal Roadshow after 9:00 AM ET on December 20, 2021

Deal Roadshow Investor Login Details:

URL: <https://dealroadshow.com>

Entry Code: SENTIBIO

Direct Link: <https://dealroadshow.com/e/SENTIBIO>

About Senti Bio

Senti Bio's mission is to create a new generation of smarter medicines that outmaneuver complex diseases using novel and unprecedented approaches. To accomplish this, we are building a synthetic biology platform that may enable us to program next-generation cell and gene therapies with what we refer to as Gene Circuits. These Gene Circuits, which are created from novel and proprietary combinations of DNA sequences, are designed to reprogram cells with biological logic to sense inputs, compute decisions, and respond to their cellular environments. We aim to design Gene Circuits to improve the intelligence of cell and gene therapies in order to enhance their therapeutic effectiveness, precision, and durability against a broad range of diseases that conventional medicines do not readily address. Our synthetic biology platform utilizes allogeneic chimeric antigen receptor natural killer (CAR-NK) cells, outfitted with these Gene Circuit technologies, to target particularly challenging liquid and solid oncology indications, including acute myeloid leukemia, hepatocellular carcinoma, and colorectal cancer. We have also demonstrated the breadth of our Gene Circuits in other modalities and diseases outside of oncology, and have executed partnerships with Spark and BlueRock to advance these capabilities.

Senti Bio is led by Tim Lu, MD, PhD, Co-Founder and Chief Executive Officer, and former tenured faculty member at MIT. Dr. Lu co-founded Senti with former MIT classmate Philip Lee, who received his PhD from the University of California at Berkeley and University of California San Francisco's joint graduate program in bioengineering. Dr. Lee was Co-Founder and CEO of CellASIC, a leading cell technologies company that was acquired by Merck KGaA, where he served as New Business Initiatives Lead and Head of Cell Culture Systems. Senti's other co-founders include Prof. James Collins, Termeer Professor of Medical Engineering & Science at MIT and a member of all three United States National Academies, and Prof. Wilson Wong, tenured faculty member at Boston University. Dr. Lu, Prof. Collins, and Prof. Wong, along with Senti's synthetic biology team and advisors, have pioneered the field of mammalian synthetic biology, having published many of the seminal papers over the last twenty years. Senti Bio's team comprises industry-leading experts, engineers, and advisors, who have deep expertise across synthetic biology, cell and gene therapy, and drug development. For more information, please visit the Senti Bio website at <https://www.sentibio.com>.

About Dynamics Special Purpose Corp.

Dynamics was formed in May 2021 for the purpose of effecting a merger, capital stock exchange, asset acquisition, stock purchase, reorganization, or similar business combination. It focused its search in healthcare and the life sciences, including development platforms that enable applications in prevention, diagnosis, treatment, or advanced biomaterials—and, within that context, life-sciences tools, enabling software, synthetic biology, and novel drug discovery.

The management team includes Omid Farokhzad, MD, Executive Chair of the Board of Directors and CEO and Chair of Seer (NASDAQ: SEER); Mostafa Ronaghi, PhD, Chief Executive Officer and former Chief Technology Officer of Illumina (NASDAQ: ILMN); Mark Afrasiabi, JD, Chief Financial Officer and former partner at Silver Rock Financial LP; and Rowan Chapman, PhD, Chief Business Officer and former regional head of Johnson & Johnson Innovation and global head of healthcare investing at GE Ventures. Dynamics' independent directors include Jay Flatley, interim CEO and Chair of Zymergen (NASDAQ: ZY) and former CEO of Illumina; David Epstein, former CEO of Novartis Pharmaceuticals; and Deep Nishar, Senior Managing Director of the Softbank Vision Fund. Dynamics' Chief Scientific Advisor, Robert Langer, ScD, is the David H. Koch Institute Professor at MIT and a co-founder of over 30 companies, including Moderna (NASDAQ: MRNA).

Forward-Looking Statements

This document contains certain forward-looking statements within the meaning of the "safe harbor" provisions of the United States Private Securities Litigation Reform Act of 1995 with respect to the proposed transaction between Dynamics Special Purpose Corp. ("Dynamics") and Senti Bio ("Senti Bio"). These forward-looking statements generally are identified by the words "believe," "could," "predict," "continue," "ongoing," "project," "expect," "anticipate," "estimate," "intend," "strategy," "future," "opportunity," "plan," "may," "should," "will," "would," "will be," "will continue," "will likely result," "forecast," "seek," "target" and similar expressions that predict or indicate future events or trends or that are not statements of historical matters. Forward-looking statements are predictions, projections and other statements about future events that are based on current expectations of Senti Bio's and Dynamics' management and assumptions, whether or not identified in this document, and, as a result, are subject to risks and uncertainties. Forward-looking statements include, but are not limited to, statements regarding estimates and forecasts of financial and performance metrics, projections of market opportunity and market share, expectations and timing related to commercial product launches, potential benefits of the proposed business combination and the potential success of Senti Bio's go-to-market strategy, the initial market capitalization of the combined company, the benefits of the business combination, as well as statements about the potential attributes and benefits of Senti Bio's product candidates and the progress and timing of Senti Bio's product development activities, IND filings and clinical trials and expectations related to the terms and timing of the proposed business combination. These forward-looking statements are provided for illustrative purposes only and are not intended to serve as, and must not be relied on by any investor as, a guarantee, an assurance, a prediction or a definitive statement of fact or probability. Actual events and circumstances are difficult or impossible to predict and will differ from assumptions. Many actual events and circumstances are beyond the control of Senti Bio and Dynamics. Many factors could cause actual future events to differ materially from the forward-looking statements in this document, including but not limited to: (i) the risk that the transaction may not be completed in a timely manner or at all, which may adversely affect the price of Dynamics' securities, (ii) changes in domestic and foreign business, market, financial, political and legal conditions, (iii) the failure to satisfy the conditions to the consummation of the transaction, including the adoption of the business combination agreement by the stockholders of Dynamics, the satisfaction of the minimum closing cash condition following redemptions by Dynamics' public stockholders and the receipt of certain governmental and regulatory approvals, (iv) the inability to complete the PIPE investment in connection with the transaction, (v) the occurrence of any event, change or other circumstance that could give rise to the termination of the business combination agreement, (vi) the effect of the announcement or pendency of the transaction on Senti Bio's business relationships, operating results and business generally, (vii) risks that the proposed transaction disrupts current plans and operations of Senti Bio and potential difficulties in Senti Bio employee retention as a result of the transaction, (viii) the outcome of any legal proceedings that may be instituted against Senti Bio or Dynamics related to the business combination agreement or the transaction, or any governmental or regulatory proceedings, investigations or inquiries, (ix) the risk that the combined company's securities will not be approved for listing and the ability to maintain the listing of Dynamics' securities on a national securities exchange, (x) volatility in the price of Dynamics' securities, which may arise due to a variety of factors, including changes in the competitive and highly regulated industries in which Dynamics plans to operate and Senti Bio currently operates, variations in operating performance across

competitors, changes in laws and regulations affecting Dynamics' or Senti Bio's business and changes in the proposed capital structure of the combined company, (xi) the ability to implement business plans, forecasts and other expectations after the completion of the proposed transaction, to realize the anticipated benefits of the proposed transaction, and to identify and realize additional opportunities, (xii) the risk of downturns and a changing regulatory landscape in Senti Bio's highly competitive industry, (xiii) the lack of third party valuation in determining whether or not to pursue the proposed transaction, (xiv) risks relating to the uncertainty of any projected financial information with respect to Senti Bio, (xv) risks related to uncertainty in the timing or results of Senti Bio's preclinical studies and any future clinical trials, product acceptance and/or receipt of regulatory approvals for Senti Bio's product candidates, (xvi) the ability of the combined company to compete effectively and its ability to manage growth, (xvii) risks related to delays and other impacts from the COVID 19 pandemic, (xviii) the amount of redemption requests made by Dynamics' public shareholders, (xix) the ability of Dynamics or the combined company to issue equity or equity-linked securities in connection with the proposed transaction or in the future, and (xx) the success of any future research, development and commercialization efforts by the combined company. The foregoing list of factors is not exhaustive. You should carefully consider the foregoing factors and the other risks and uncertainties described in the "Risk Factors" section of Dynamics' registration statement on Form S-1, as amended (File No. 333-255930), the registration statement on Form S-4 to be filed with the Securities and Exchange Commission ("SEC") in connection with the proposed transaction, and other documents filed by Dynamics from time to time with the SEC, including its amended audited balance sheet (originally as of May 28, 2021, and included as Exhibit 99.1 to the Company's Current Report on Form 8-K filed with the SEC on June 4, 2021) (dated December 10, 2021) and amended Quarterly Reports on Form 10-Q for the quarters ended June 30, 2021 (dated December 10, 2021) and September 30, 2021 (dated December 10, 2021). These filings identify and address other important risks and uncertainties that could cause actual events and results to differ materially from those contained in the forward-looking statements in this document. There may be additional risks that neither Dynamics nor Senti Bio presently knows, or that Dynamics and Senti Bio currently believe are immaterial that could also cause actual results to differ from those contained in the forward-looking statements in this document. Forward-looking statements speak only as of the date they are made. Dynamics and Senti anticipate that subsequent events and developments will cause Dynamics' and Senti Bio's assessments to change. Readers are cautioned not to put undue reliance on forward-looking statements, and except as required by law, Dynamics and Senti Bio disclaim any obligation to and do not intend to update or revise these forward-looking statements, whether as a result of new information, future events, or otherwise. Neither Dynamics nor Senti Bio gives any assurance that either Dynamics or Senti Bio or the combined company will achieve any of its expectations.

Any financial projections in this document are forward-looking statements that are based on assumptions that are inherently subject to significant uncertainties and contingencies, many of which are beyond Dynamics' and Senti Bio's control. While all projections are necessarily speculative, Dynamics and Senti Bio believe that the preparation of prospective financial information involves increasingly higher levels of uncertainty the further out the projection extends from the date of preparation. The assumptions and estimates underlying the projected results are inherently uncertain and are subject to a wide variety of significant business, economic and competitive risks and uncertainties that could cause actual results to differ materially from those contained in the projections (refer to the preceding paragraph in relation to forward-looking statements). The inclusion of projections in this document should not be regarded as an indication, representation or warranty that Dynamics and Senti Bio, or their representatives, considered or consider the projections to be a reliable prediction of future events.

Additional Information About the Proposed Business Combination and Where To Find It

The proposed business combination will be submitted to shareholders of Dynamics for their consideration. Dynamics intends to file a registration statement on Form S-4 (the "Registration Statement") with the SEC which will include preliminary and definitive proxy statements to be distributed to Dynamics' shareholders in connection with Dynamics' solicitation for proxies for the vote by Dynamics' shareholders in connection with the proposed business combination and other matters as described in the Registration Statement, as well as the prospectus relating to the offer of the securities to be issued to Senti Bio's shareholders in connection with the completion of the proposed business combination. After the Registration Statement has been filed and declared effective, Dynamics will mail a definitive proxy statement and other relevant documents to its shareholders as of the record date established for voting on the proposed business combination. **Dynamics' shareholders and other interested persons are advised to read, once available, the preliminary proxy statement / prospectus and any amendments thereto and, once available, the definitive proxy statement / prospectus, in connection with Dynamics' solicitation of proxies for its special meeting of shareholders to be held to approve, among other things, the proposed business combination, because these documents will contain important information about Dynamics, Senti and the proposed business combination.** Shareholders may also obtain a copy of the preliminary or definitive proxy statement, once available, as well as other documents filed with the SEC regarding the proposed business combination and other documents filed with the SEC by Dynamics, without charge, at the SEC's website located at www.sec.gov or by directing a request to 2875 El Camino Real, Redwood City, CA, 94061.

INVESTMENT IN ANY SECURITIES DESCRIBED HEREIN HAS NOT BEEN APPROVED OR DISAPPROVED BY THE SEC OR ANY OTHER REGULATORY AUTHORITY NOR HAS ANY AUTHORITY PASSED UPON OR ENDORSED THE MERITS OF THE OFFERING OR THE ACCURACY OR ADEQUACY OF THE INFORMATION CONTAINED HEREIN. ANY REPRESENTATION TO THE CONTRARY IS A CRIMINAL OFFENSE.

Participants in the Solicitation

Dynamics, Senti Bio and certain of their respective directors, executive officers and other members of management, employees and consultants may, under SEC rules, be deemed to be participants in the solicitations of proxies from Dynamics' shareholders in connection with the proposed business combination. Information regarding the persons who may, under SEC rules, be deemed participants in the solicitation of Dynamics' shareholders in connection with the proposed business combination will be set forth in Dynamics' proxy statement / prospectus when it is filed with the SEC. You can find more information about Dynamics' directors and executive officers in Dynamics' final prospectus dated May 25, 2021 and filed with the SEC on May 27, 2021. Additional information regarding the participants in the proxy solicitation and a description of their direct and indirect interests will be included in the proxy statement / prospectus when it becomes available. Shareholders, potential investors and other interested persons should read the proxy statement / prospectus carefully when it becomes available before making any voting or investment decisions. You may obtain free copies of these documents from the sources indicated above.

No Offer or Solicitation

This press release does not constitute an offer to sell or the solicitation of an offer to buy any securities, or a solicitation of any vote or approval, nor shall there be any sale of securities in any jurisdiction in which such offer, solicitation or sale would be unlawful prior to registration or qualification under the securities laws of any such jurisdiction. This press release relates to a potential offering of securities that will not be registered under the Securities Act of 1933, as amended (the "Securities Act"), and will be offered as a private placement pursuant to an exemption from registration under the Securities Act. This press release shall not constitute a "solicitation" as defined in Section 14 of the Securities Exchange Act of 1934, as amended. Neither Dynamics, Senti nor any of their respective directors, executive officers or other members of management, employees or consultants is making an offering of any securities in any state where the offer is not permitted.

###

Contact Senti Bio:

Deb Knobelman, PhD, CFO
Email: corporate@sentibio.com

Find more information at sentibio.com
Follow us on LinkedIn: Senti Biosciences
Follow us on Twitter: [@SentiBio](https://twitter.com/SentiBio)

Contact Dynamics Special Purpose Corp.:

Investor Relations
Email: irbd@dspc.bio

Find more information at dspc.bio

Kelli Perkins (Media)
Email: kelli@redhousecomms.com



Outsmarting Complex Diseases with Intelligent Medicines

Corporate Overview

December 2021





Disclaimer

This presentation ("Presentation") is for informational purposes only to assist interested parties in making their own evaluation with respect to the proposed business combination (the "Business Combination") between Dynamics Special Purpose Corp. ("Dynamics") and Senti Biosciences, Inc. ("Senti") and a potential investment in connection therewith (the "Purpose"). By accepting this Presentation, the recipient acknowledges and agrees that all of the information contained herein is confidential, that the recipient will distribute, disclose, and use such information only for such Purpose and that the recipient shall not distribute, disclose or use such information in any way detrimental to Senti or Dynamics. The information contained herein does not purport to be all-inclusive and none of Dynamics, Senti, J.P. Morgan Securities LLC ("JPM"), Morgan Stanley & Co. LLC ("MS"), or BofA Securities, Inc. ("BoFA") nor any of their respective affiliates nor any of its or their controlling persons, officers, directors, employees or representatives makes any representation or warranty, express or implied, as to the accuracy, completeness or reliability of the information contained in this Presentation. You should consult your own counsel and tax and financial advisors as to legal and related matters concerning the matters described herein, and, by accepting this Presentation, you confirm that you are not relying upon the information contained herein to make any decision.

ANY SECURITIES TO BE OFFERED IN ANY TRANSACTION CONTEMPLATED HEREIN HAVE NOT BEEN REGISTERED UNDER THE SECURITIES ACT OF 1933, AS AMENDED (THE "SECURITIES ACT"), OR ANY APPLICABLE STATE OR FOREIGN SECURITIES LAW. ANY SECURITIES TO BE OFFERED IN ANY TRANSACTION CONTEMPLATED HEREIN HAVE NOT BEEN APPROVED OR DISAPPROVED BY THE SECURITIES EXCHANGE COMMISSION (THE "SEC"), ANY STATE SECURITIES COMMISSION OR OTHER UNITED STATES OR FOREIGN REGULATORY AUTHORITY, AND WILL BE OFFERED AND SOLD SOLELY IN RELIANCE ON THE EXEMPTION FROM THE REGISTRATION REQUIREMENTS PROVIDED BY THE SECURITIES ACT AND RULES AND REGULATIONS PROMULGATED THEREUNDER (INCLUDING REGULATION D OR REGULATION S UNDER THE SECURITIES ACT). THIS PRESENTATION DOES NOT CONSTITUTE, OR FORM A PART OF, AN OFFER TO SELL OR THE SOLICITATION OF AN OFFER TO BUY IN ANY STATE OR OTHER JURISDICTION TO ANY PERSON TO WHOM IT IS UNLAWFUL TO MAKE SUCH OFFER OR SOLICITATION IN SUCH STATE OR JURISDICTION.

Certain statements in this Presentation may be considered forward-looking statements. Forward-looking statements generally relate to future events or Dynamics's or Senti's future financial or operating performance. For example, statements concerning the following include forward-looking statements: Senti's ability to identify, develop and commercialize product candidates; the initiation, cost, timing, progress and results of research and development activities, preclinical or clinical trials with respect to Senti's drug candidates; future revenue, expenses, capital requirements and needs for additional financing; and the potential effects of the Business Combination on Dynamics and Senti and related capital raising activities. In some cases, you can identify forward-looking statements by terminology such as "may", "should", "expect", "intend", "will", "estimate", "anticipate", "believe", "predict", "potential" or "continue", or the negatives of these terms or variations of them or similar terminology. Such forward-looking statements are subject to risks, uncertainties, and other factors which could cause actual results to differ materially from those expressed or implied by such forward-looking statements. These forward-looking statements are based upon estimates and assumptions that, while considered reasonable by Dynamics and its management, and Senti and its management, as the case may be, are inherently uncertain. New risks and uncertainties may emerge from time to time, and it is not possible to predict all risks and uncertainties. Factors that may cause actual results to differ materially from current expectations include, but are not limited to, various factors beyond management's control including general economic conditions and other risks, uncertainties and factors set forth in the section entitled "Risk Factors" and "Cautionary Note Regarding Forward-Looking Statements" in Dynamics's final prospectus relating to its initial public offering, dated May 25, 2021, and other filings with the SEC, as well as factors associated with companies, such as Senti, that are engaged in preclinical studies and other research and development activities in the biopharma industry, including uncertainty in the timing or results of preclinical studies and clinical trials, product acceptance and/or receipt of regulatory approvals for product candidates, including any delays and other impacts from the COVID-19 pandemic. Nothing in this Presentation should be regarded as a representation by any person that the forward-looking statements set forth herein will be achieved or that any of the contemplated results of such forward-looking statements will be achieved. You should not place any reliance on forward-looking statements in this Presentation, which speak only as of the date they are made and are qualified in their entirety by reference to the cautionary statements herein. Neither Dynamics nor Senti undertakes any duty to update these forward-looking statements.

Certain information contained in this Presentation relates to or is based on studies, publications, surveys and Senti's own internal estimates and research. In addition, all of the market data included in this Presentation involve a number of assumptions and limitations, and there can be no guarantee as to the accuracy or reliability of such assumptions. Finally, while Senti believes its internal research is reliable, such research has not been verified by any independent source. This Presentation and any information communicated at any meetings related to your evaluation of the Business Combination are strictly confidential and should not be discussed outside your organization.

Dynamics has retained JPM, MS and BoFA as placement agents (together with their affiliates, partners, directors, agents, employees, representatives, and controlling persons, the "Placement Agents") with respect to capital raising activities in connection with the Business Combination. The Placement Agents are acting solely as placement agents (and, for the avoidance of doubt, not as underwriters, initial purchasers, dealers or any other principal capacity) for Dynamics in connection with a potential transaction. The Placement Agents have not independently verified any of the information contained herein or any other information that has been or will be provided to you. Nothing contained herein or in any other oral or written information provided to you is, nor shall be relied upon as, a promise or representation of any kind by the Placement Agents, Dynamics or Senti, whether as to the past or the future. Without limitation of the foregoing, none of the Placement Agents, Dynamics or Senti shall be liable to you or any prospective investor or any other person for any information contained herein or that otherwise has been or will be provided to you, or any action heretofore or hereafter taken or omitted to be taken, in connection with this potential transaction. This presentation is being distributed solely for the consideration of sophisticated prospective purchasers who are institutional accredited investors with sufficient knowledge and experience in investment, financial and business matters and the capability to conduct their own due diligence investigation and evaluation in connection with the Purpose. This presentation does not purport to summarize all of the conditions, risks and other attributes of an investment in Dynamics or Senti. Information contained herein will be superseded by, and is qualified in its entirety by reference to, any other information that is made available to you in connection with the Purpose, including your investigation of Dynamics and Senti.

Additional Information. In connection with the proposed Business Combination, Dynamics intends to file with the SEC a registration statement on Form S-4 containing a preliminary proxy statement/prospectus of Dynamics, and after the registration statement is declared effective, Dynamics will mail a definitive proxy statement/prospectus relating to the proposed Business Combination to its shareholders. This Presentation does not contain all the information that should be considered concerning the proposed Business Combination and is not intended to form the basis of any investment decision or any other decision in respect of the Business Combination. Dynamics's shareholders and other interested persons are advised to read, when available, the preliminary proxy statement/prospectus and the amendments thereto and the definitive proxy statement/prospectus and other documents filed in connection with the proposed Business Combination, as these materials will contain important information about Senti, Dynamics and the Business Combination. When available, the definitive proxy statement/prospectus and other relevant materials for the proposed Business Combination will be mailed to shareholders of Dynamics as of a record date to be established for voting on the proposed Business Combination. Dynamics shareholders will also be able to obtain copies of the preliminary proxy statement/prospectus, the definitive proxy statement/prospectus and other documents filed with the SEC, without charge, once available, at the SEC's website at www.sec.gov, or by directing a request to www.dipc.bio.

Participants in the Solicitation. Dynamics and its directors and executive officers may be deemed participants in the solicitation of proxies from Dynamics's shareholders with respect to the proposed Business Combination. A list of the names of those directors and executive officers and a description of their interests in Dynamics is contained in Dynamics's final prospectus relating to its initial public offering, dated May 25, 2021, which was filed with the SEC and is available free of charge at the SEC's web site at www.sec.gov, or by directing a request to www.dipc.bio. Additional information regarding the interests of such participants will be contained in the proxy statement/prospectus for the proposed Business Combination when available.



SENTI BIO

Senti Bio designs gene circuits for next-gen cell and gene therapies

Proprietary gene circuit technology platform enables the development of “smart” next-gen cell and gene therapies with enhanced efficacy, safety and control

Multiple therapeutic modalities (e.g. NK cells, T cells, iPSCs, gene therapy, mRNA, etc.) offering vast opportunities

Potential to address patients with high unmet needs in oncology, immunology, genetic diseases, neurology, cardiology, ophthalmology, and more

Differentiated Allogeneic CAR-NK Oncology Pipeline and Collaborations with Spark (Roche) and BlueRock (Bayer)

Allogeneic CAR-NK Anticipated IND filings in 2023 for product candidates SENTI-202 (AML) and SENTI-301 (HCC)

Note: Acute Myeloid Leukemia (AML), Hepatocellular Carcinoma (HCC)



Senti is Founded and Led by Pioneers in Synthetic Biology and Cell Technologies

FOUNDING TEAM



Tim Lu, M.D., Ph.D.
CEO



Philip Lee, Ph.D.
CTO



Jim Collins, Ph.D.
SCIENTIFIC ADVISOR



Wilson Wong, Ph.D.
SCIENTIFIC ADVISOR

SENTI FOUNDERS' AFFILIATIONS



WORLD-CLASS COMPANY FOUNDERS



REPRESENTATIVE PUBLICATIONS





Today's Cell and Gene Therapies Cannot Resolve Fundamental Disease Challenges

CURRENT CELL AND GENE THERAPIES ARE SIMPLISTIC...

...AND CANNOT OVERCOME FUNDAMENTAL DISEASE CHALLENGES



Unable to precisely distinguish diseased versus healthy cells



TARGET HETEROGENEITY

Unable to overcome multiple disease mechanisms



DISEASE EVASION

Unable to be regulated after delivery into patients



NARROW THERAPEUTIC WINDOW

Unable to adapt to disease conditions



DYNAMIC DISEASE CONDITIONS



Senti's Gene Circuits Use Biological Computation to Solve Biological Problems

Evolution has selected for natural genetic circuits

Genetic Parts

Transcription factor

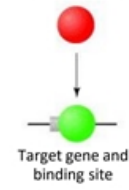

Gene Circuits

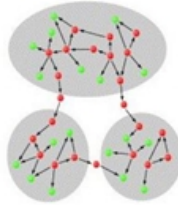

Gene Networks



Adopted from Babu et. al. Curr Opin in Structural Bio, 14(3), 2004

SENTI BIO
Learning from evolution, Senti creates intelligent gene circuits

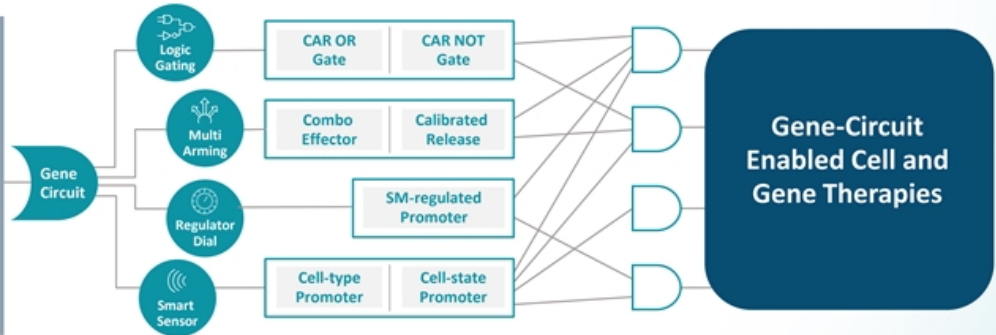



Powerful and Scalable Engine Optimizes Gene Circuits to Enable Creation of Intelligent Medicines

SENTI'S DESIGN-BUILD-TEST-LEARN ENGINE

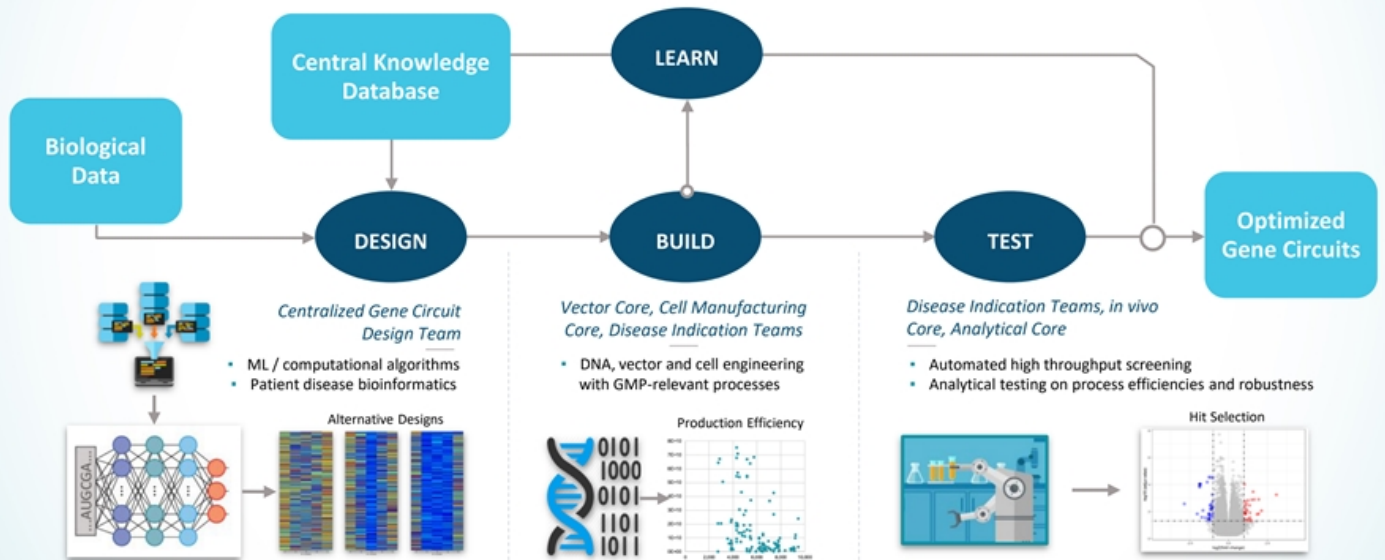



Senti's Gene Circuit Platform is Designed to Overcome Fundamental Disease Challenges

FUNDAMENTAL DISEASE CHALLENGES...

...ARE TACKLED THROUGH INTELLIGENT GENETIC PROGRAMMING



TARGET HETEROGENEITY



LOGIC GATING

Integrates multiple targets to pinpoint diseased cells and spare healthy ones



DISEASE EVASION



MULTI-ARMING

Targets multiple disease pathways within a single all-in-one drug



NARROW THERAPEUTIC WINDOW



REGULATOR DIAL

Dynamically regulates therapies *in vivo* using FDA-approved oral drugs



DYNAMIC DISEASE CONDITIONS



SMART SENSOR

Precisely detects and responds to disease environments



Gene Circuits Could Potentially Power Multiple Cell and Gene Therapy Modalities for Broad Therapeutic Potential

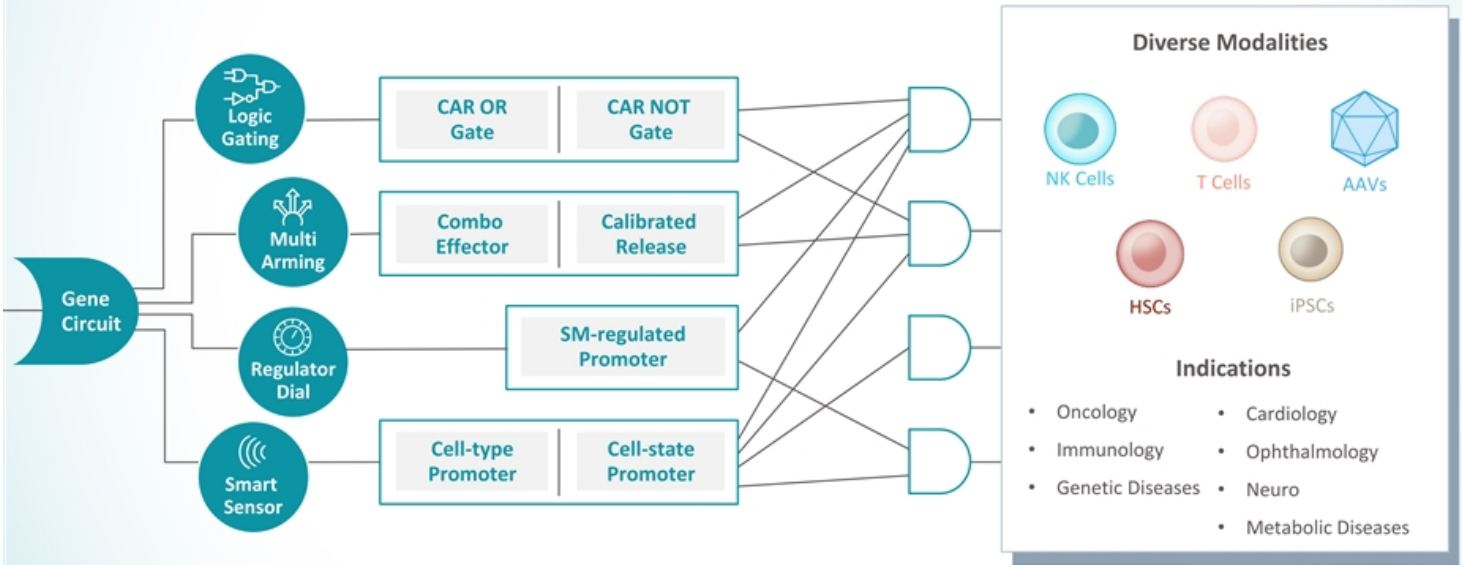



Logic Gating Enables Highly Specific Therapies by Recognizing Multiple Antigens

Toolbox of Gene Circuits



TUMOR-ASSOCIATED ANTIGENS (TAA) ENGAGEMENT TRIGGERS CANCER CELL KILLING

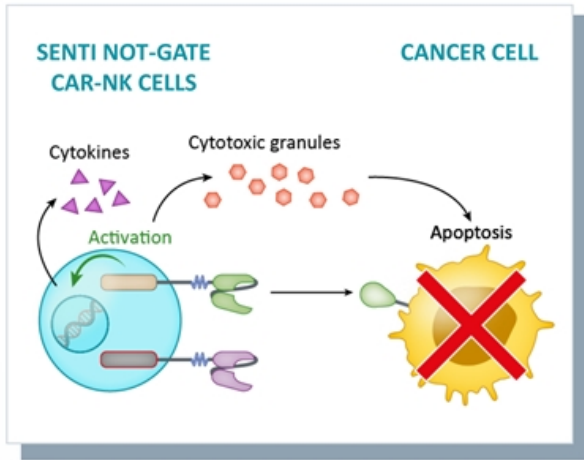

Activating CAR (aCAR) Tumor-Associated Antigens

SAFETY ANTIGEN ENGAGEMENT ENABLES PROTECTION OF HEALTHY CELLS

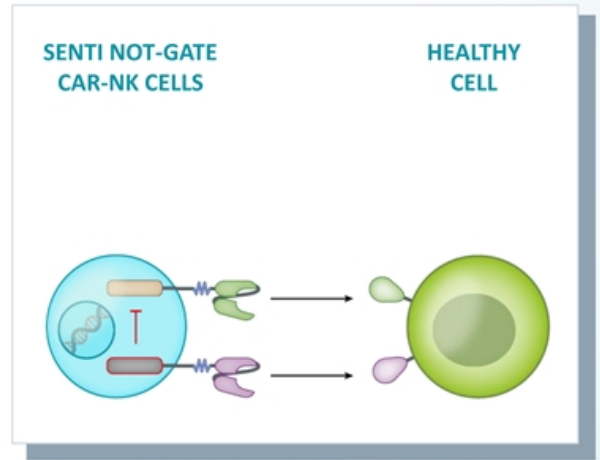

Inhibitory CAR (iCAR) Safety Antigen



NOT Logic Gate Functions In Vivo to Specifically Kill Cancer Cells and Spare Healthy Cells

Toolbox of Gene Circuits

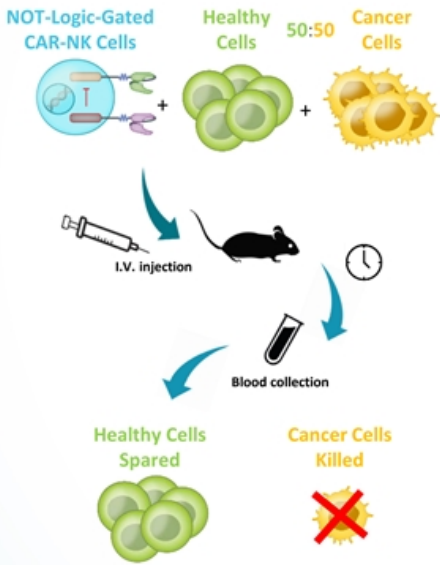
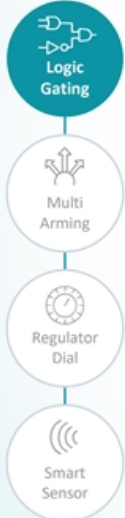

NOT-GATED CAR-NK CELLS REDUCE KILLING OF HEALTHY CELLS

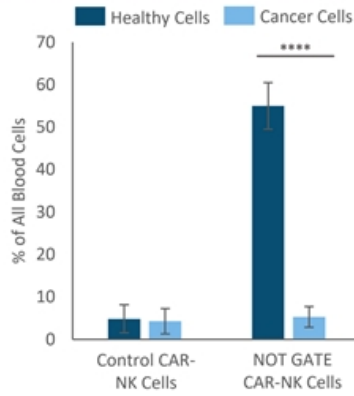

RESULTING IN ENRICHMENT OF HEALTHY CELLS

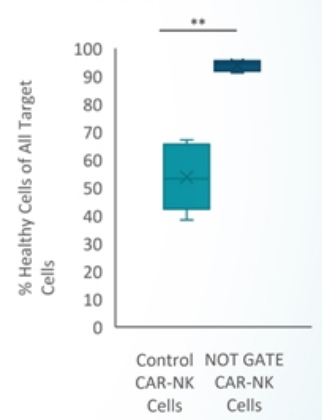

Source: Internal data



Multi-Arming Circuits Enable All-in-One Combination Cell and Gene Therapies

Toolbox of Gene Circuits

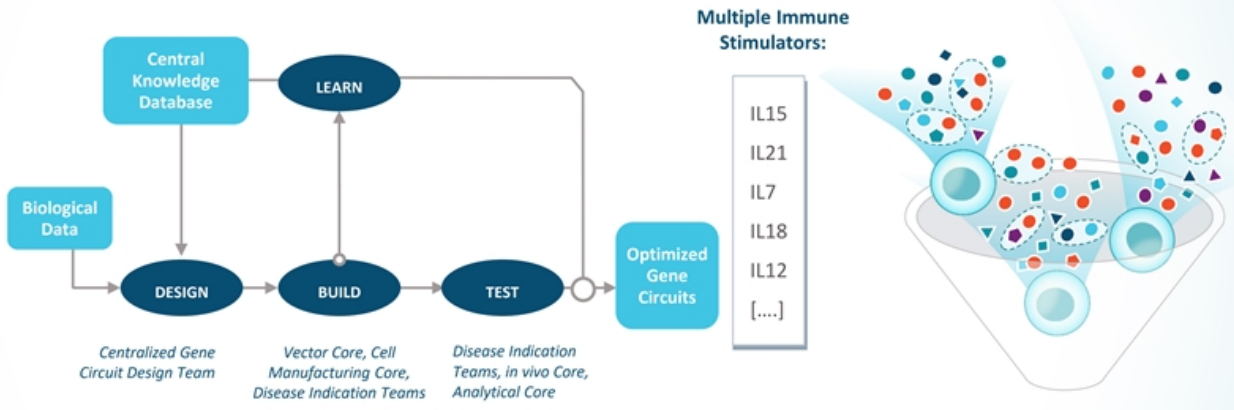

Use of Senti's Design-Build-Test-Learn Engine optimizes each payload's expression level and which combinations are expressed from Multi-Arming gene circuits to enhance therapeutic activity



Multi-Armed CAR-NK Cells Exhibit Significantly Improved Killing of Cancer Cells

Toolbox of Gene Circuits



IN VITRO TUMOR CELL KILLING (INCUCYTE)

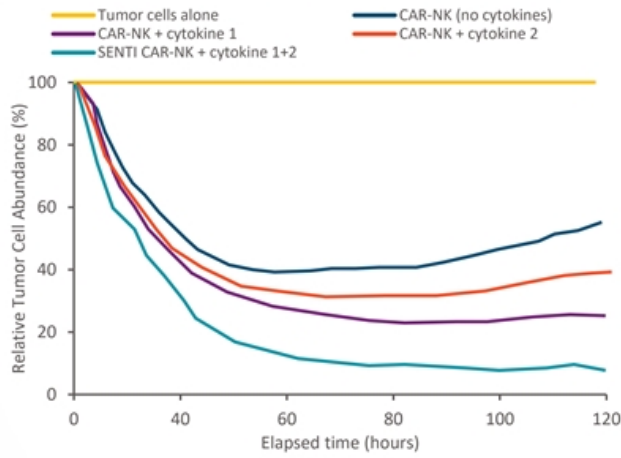

TUMOR CELL KILLING (day 5 post co-culture, 2:1 ratio)

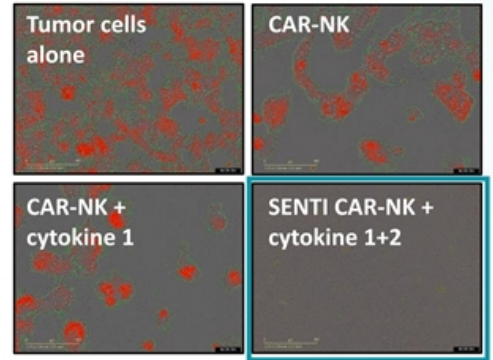

Red fluorescence = tumor cells

Arming of CAR-NK cells using a combination of cytokines results in potent and durable killing

Source: Internal data



Regulator Dial Circuit Potentially Enables Control of Cell Therapies Using FDA-Approved Drugs

Toolbox of Gene Circuits

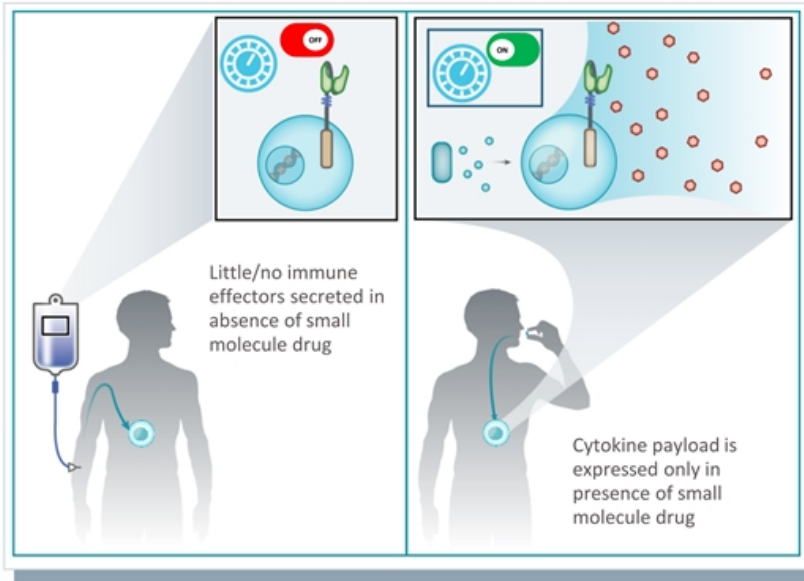

MULTIPLE DRUG SWITCHES:

- HCV protease inhibitors
- IMiDs
- Tamoxifen



Regulator Dial Enables ~90-fold ON/OFF Control of IL-12 Secretion *In Vivo*

Toolbox of Gene Circuits



STUDY DESIGN

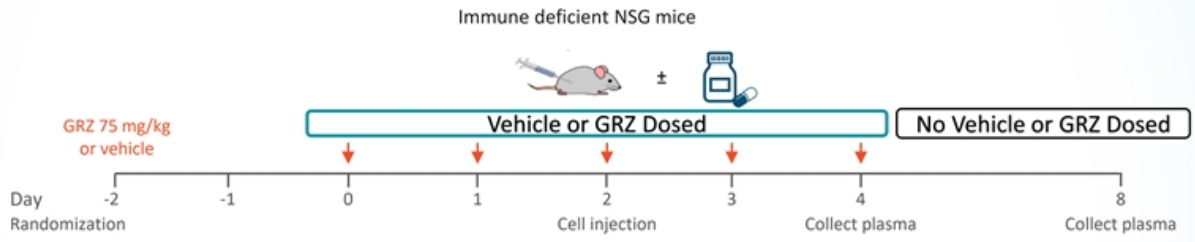

IL-12 DETECTED IN MOUSE PLASMA

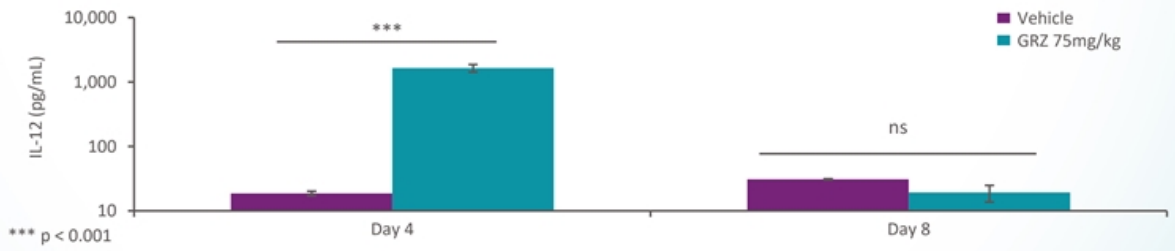

Source: Internal data



Smart Sensors Enable Precise and Dynamic Recognition of Diseased Cells

Toolbox of Gene Circuits

- Logic Gating
- Multi Arming
- Regulator Dial
- Smart Sensor

CURRENT GENE THERAPIES LACK SPECIFICITY FOR SPECIFIC DISEASED CELL TYPES

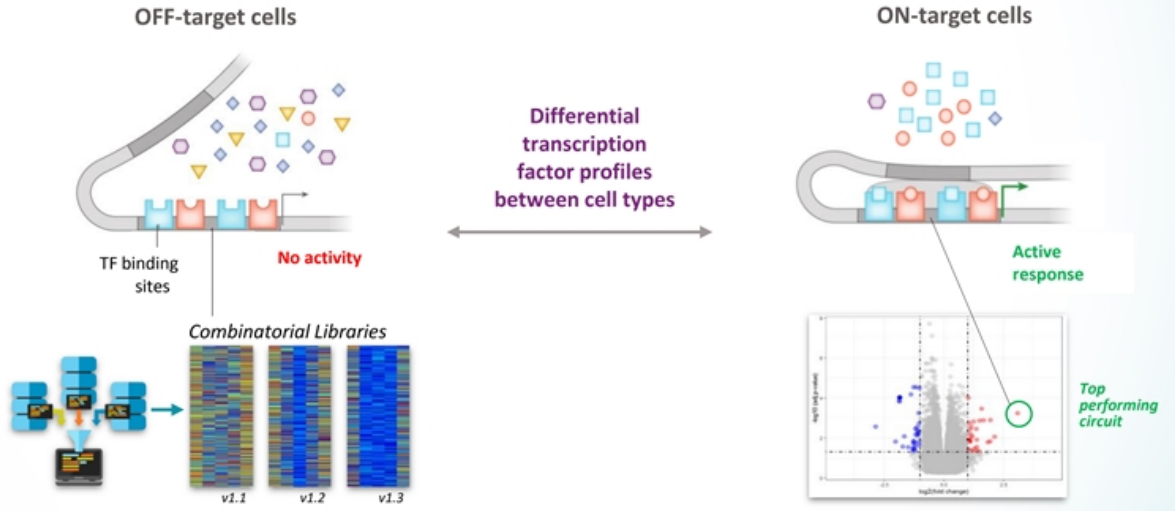



Smart Sensor Promoters Enable up to 1,000-fold Selectivity for Diseased Cells

Toolbox of Gene Circuits

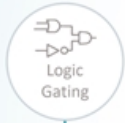

SIGNALS SUCH AS TRANSCRIPTION FACTOR(S)

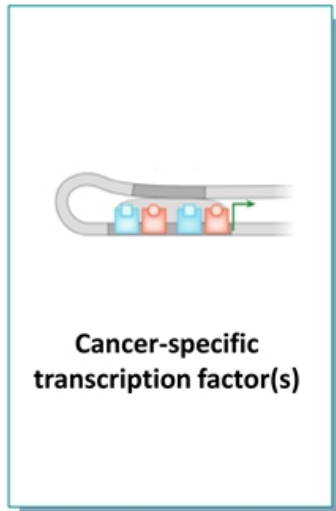



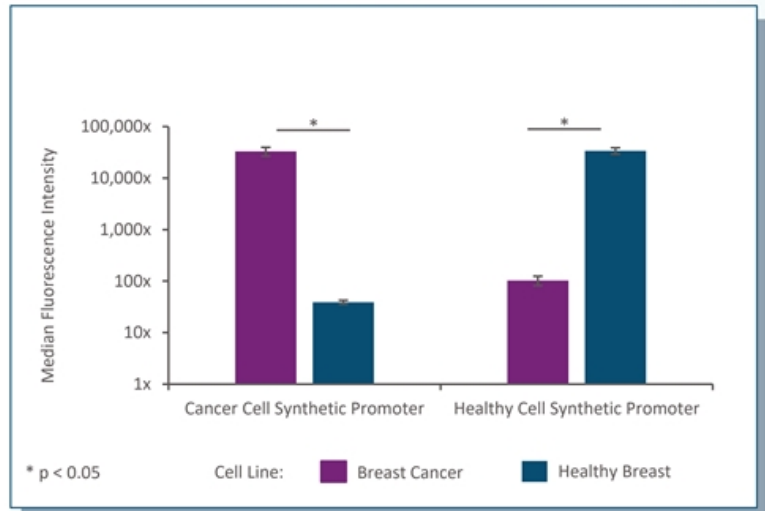







GENE THERAPY WITH TRANSGENE EXPRESSION UP TO ~1,000X CELL TYPE SELECTIVITY



Source: Wu et al. Nature Communications 10, Article number 2880 (2019)



Gene Circuit Enabled Pipeline With Additional Collaboration Opportunities

Modality	Gene Circuit	Name	Indication	Discovery	Preclinical	Phase 1	Phase 2	Phase 3	Rights
 Allogeneic NK Cells for Oncology	 Logic Gating	SENTI-202	Acute Myeloid Leukemia	[Progress bar: Discovery to Preclinical]					
		SENTI-401	Colorectal Cancer	[Progress bar: Discovery to Phase 1]					
		SENTI-411	Solid Tumors	[Progress bar: Discovery to Phase 1]					
		SENTI-421	Solid/Liquid Tumors	[Progress bar: Discovery to Phase 1]					
	 Multi-Arming	SENTI-301	Hepatocellular Carcinoma	[Progress bar: Discovery to Phase 2]					
		SENTI-311	Solid Tumors	[Progress bar: Discovery to Phase 1]					
 Gene Therapies for Tissue-Directed Targets	 Smart Sensor	GC-1001 /-1002	Ocular	[Progress bar: Discovery to Phase 1]					
		GC-1003 /-1004	Central Nervous System	[Progress bar: Discovery to Phase 1]					
		GC-1005	Liver	[Progress bar: Discovery to Phase 1]					
 Cell Therapies for Regenerative Medicine	 Regulator Dial	GC-1101	Regenerative Medicine	[Progress bar: Discovery to Phase 1]					
		GC-1102	Regenerative Medicine	[Progress bar: Discovery to Phase 1]					
	 Smart Sensor	GC-1103	Regenerative Medicine	[Progress bar: Discovery to Phase 1]					

Note: Spark is a wholly owned subsidiary of Roche; BlueRock is a wholly owned subsidiary of Bayer. For further details regarding the Spark and BlueRock collaborations, please see page 33 and 34.



Natural Killer (NK) Cells are an Ideal Modality for Gene-Circuit Enhanced Cancer Cell Therapy



Innate Killing

- ✓ Natural ability to kill tumor cells and spare healthy ones based on multi-receptor engagement
- ✓ Anti-tumor activity and persistence validated



Immune Activation

- ✓ Proinflammatory cytokine and chemokine secretion
- ✓ Elicit endogenous response for durable anti-tumor immunity



Favorable Safety

- ✓ Low/no incidence of GvHD vs. CAR-T
- ✓ Low risk of CRS and neurotoxicity



Broad Access

- ✓ Does not require patient derived cells
- ✓ Potential for outpatient administration
- ✓ Amenable to large scale allogeneic manufacturing



Clinical Validation

- ✓ MD Anderson CD19 CAR-NK study in advanced B cell malignancies: 7/11 (64%) CRs and no reported CRS, GvHD or neurotoxicity
- ✓ Fate Therapeutics study with FT516 in B-cell lymphoma: 6/11 (55%) CRs and no CRS, GvHD or neurotoxicity

Note: MD Anderson study data was presented at ASH 2020 and Fate Therapeutics study was presented on August 19, 2021



Senti's Proprietary Calibrated Release IL-15 (crIL-15) Enhances NK Cell Persistence and Tumor Killing

crIL-15 ENABLES BOTH AUTOCRINE AND PARACRINE SIGNALING

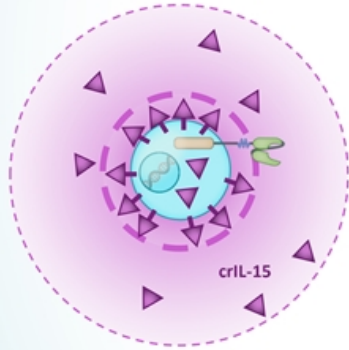

crIL-15 IMPROVES NK PERSISTENCE AND SERIAL KILLING

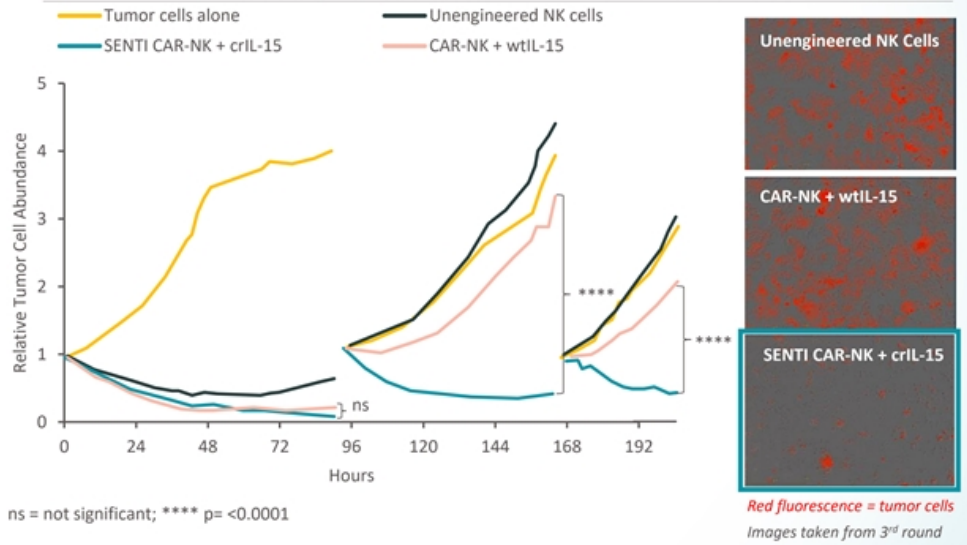

Source: Internal data



SENTI-202: Designed to Address Unmet Needs in the Treatment of Acute Myeloid Leukemia (AML)

Toolbox of Gene Circuits



SENTI'S LOGIC GATES SOLVE KEY DISEASE CHALLENGES IN AML

CHALLENGES	SENTI GENE CIRCUIT SOLUTIONS
<p>Target heterogeneity Relapse due to incomplete targeting of leukemic stem cells (LSCs)</p>	<p>OR Logic Gate Targets multiple AML tumor associated antigens</p>
<p>Target heterogeneity Off-tumor toxicity and limited efficacy due to lack of AML-specific targets</p>	<p>NOT Logic Gate Enables broad targeting of AML while preserving healthy blood stem cells</p>

UNMET NEED IN AML

5-Year Survival¹



DUE TO DISEASE RELAPSE DRIVEN BY LEUKEMIC STEM CELLS (LSCs)

SENTI'S LOGIC-GATED CAR-NK PROGRAM OFFERS POTENTIAL TO DEVELOP A CURE FOR AML PATIENTS IN THE ABSENCE OF A BONE MARROW TRANSPLANT

¹SEER Cancer Stat Facts: Acute Myeloid Leukemia



SENTI-202: Potential to Develop a Cure With No Bone Marrow Transplant Needed

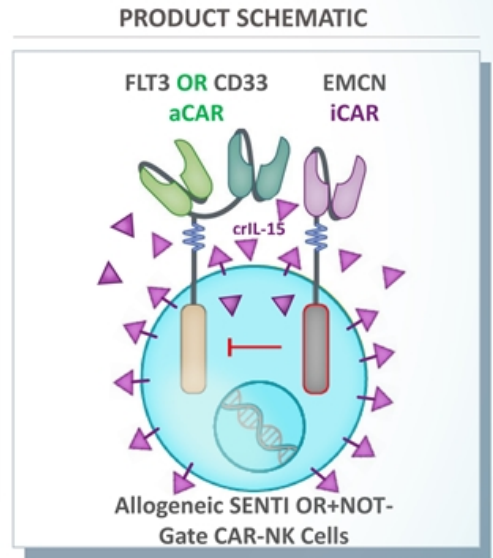
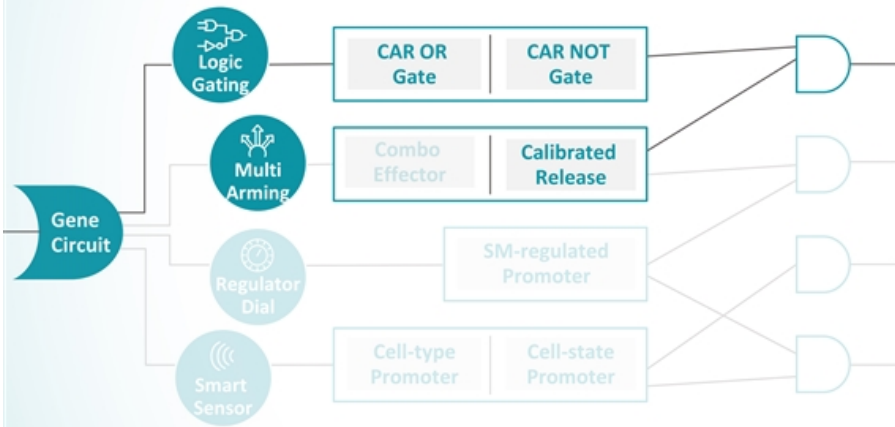



SENTI-202 OR/NOT Logic Gating: Deep Clearance of AML Blasts and AML LSCs While Sparing Healthy Hematopoietic Stem Cells (HSCs)

FLT3 OR CD33 ENGAGEMENT TRIGGERS KILLING OF HETEROGENEOUS AML CANCER CELLS

EMCN ENGAGEMENT ENABLES PROTECTION OF HEALTHY HSCs

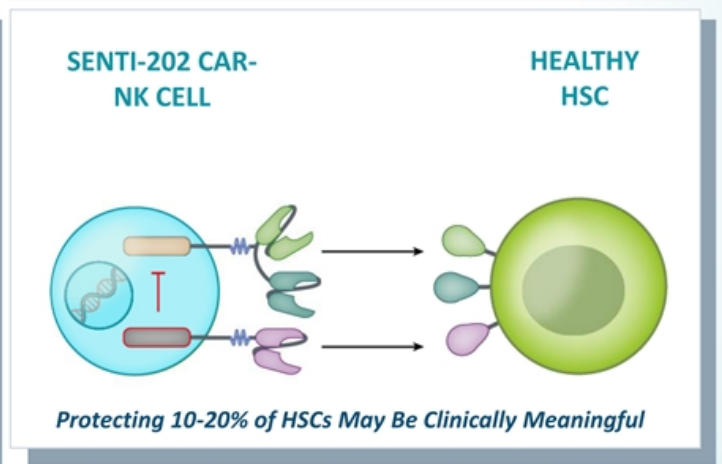
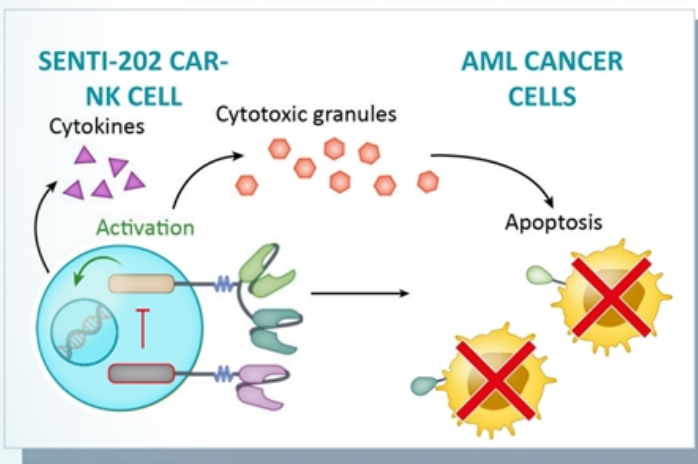

Activating CAR (aCAR) — Tumor-Associated Antigens — Inhibitory CAR (iCAR) — Safety Antigen — Antigen: CD33 — FLT3 — EMCN



FLT3 OR CD33 CAR-NK Cells Significantly Suppressed Tumor Growth, Reduced Tumor Burden and Improved Survival

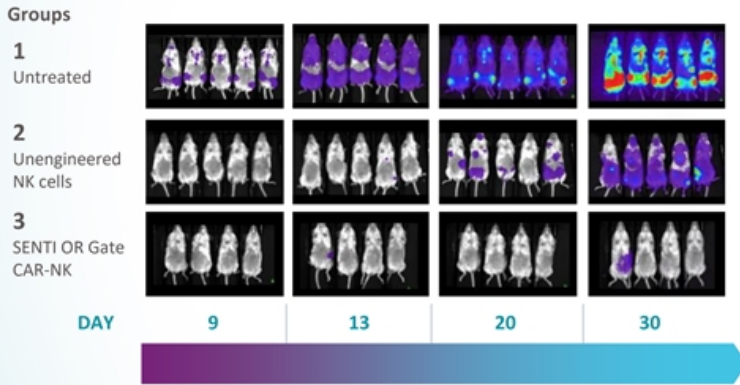
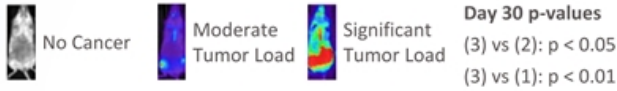

SENTI FLT3 OR CD33 CAR-NK cells achieved statistically significantly greater anti-tumor activity compared to untreated control mice ($p < 0.01$) and mice treated with unengineered NK cells ($p < 0.05$)

Source: Internal data

MV4-11-BASED AML XENOTRANSPLANTATION MODEL

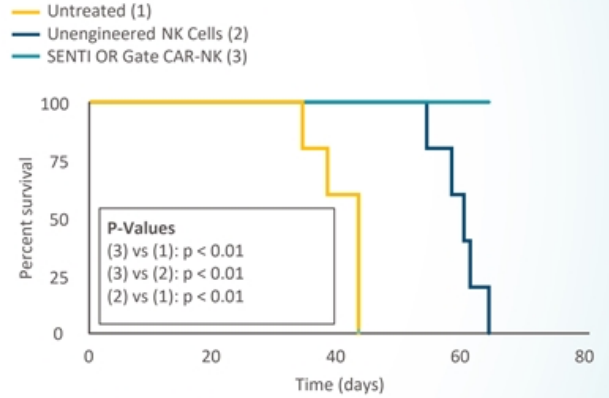

FLT3 OR CD33 CAR-NK cells significantly suppressed tumor growth and increased survival



EMCN iCAR Constructs Demonstrate Functional NOT GATE Protection of Model Healthy Cells

KEY TAKEAWAYS

CAR-NK cells without an EMCN-specific NOT GATE kill both FLT3+ and FLT3+EMCN+ cells.

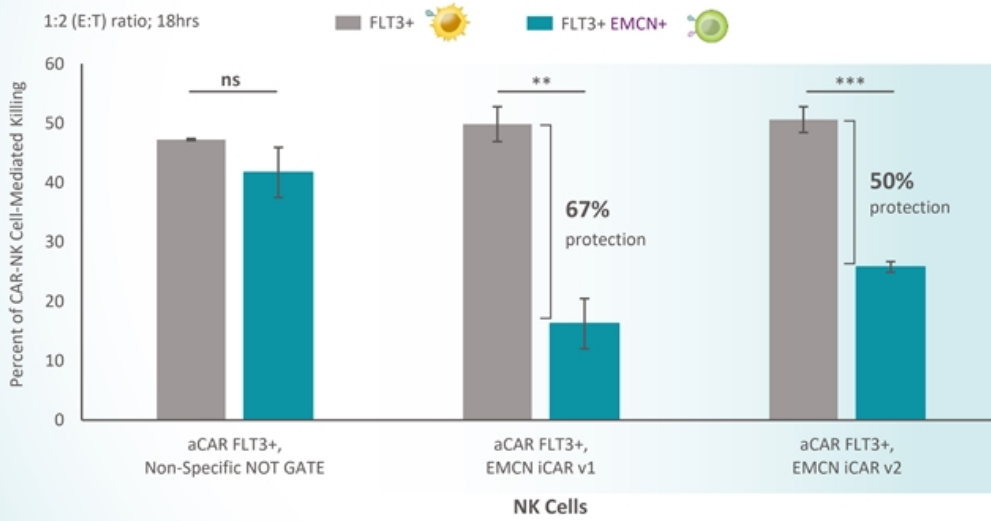

CAR-NK cells containing an EMCN-specific NOT Gate protect up to 67% of EMCN-expressing target cells while preserving effective CAR-NK-cell-mediated killing of FLT3+ cancer cells.

We believe that protecting 10-20% of Healthy HSCs is clinically meaningful.

Source: Internal data
 Note: ns = not significant; ** p < 0.01, *** p < 0.001



SENTI-202 Product Candidate Protects Primary Donor HSCs While Maintaining On-Target Killing of Cancer Cells

EMCN NOT-GATE CAR-NK CELLS EFFECTIVELY KILL AML CANCER CELLS

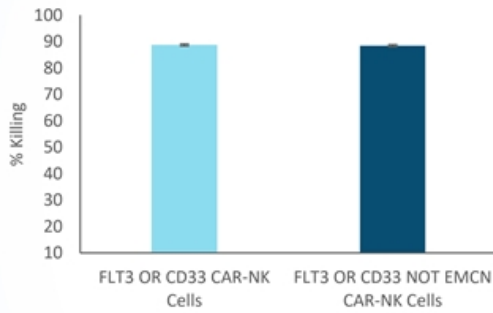

EMCN NOT-GATE CAR-NK CELLS PROTECT HEALTHY HSCs/MPPs

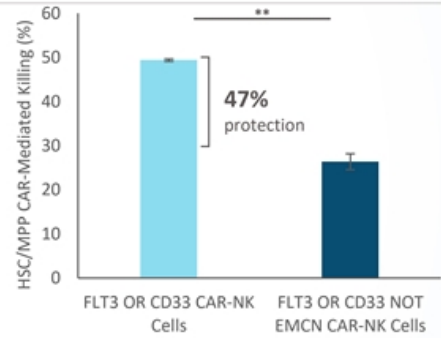

Experimental Approach:



We believe that **protecting 10-20%** of Healthy HSCs is clinically meaningful.

Source: Internal data



SENTI-301: Addressing Unmet Needs in the Treatment of Hepatocellular Carcinoma (HCC)

Toolbox of Gene Circuits



SENTI'S MULTI-ARMING AND REGULATOR DIAL GENE CIRCUITS SOLVE KEY DISEASE CHALLENGES IN HCC

CHALLENGES

Disease evasion

Suppressive tumor microenvironment (TME) limits efficacy

Narrow therapeutic window

Immuno-stimulators to overcome TME need to be controlled

SENTI GENE CIRCUIT SOLUTIONS

Multi Arming

Targets multiple pathways with potent immuno-stimulators to overcome TME

Regulator Dial

Enables exogenous switching of potent immuno-stimulators

UNMET NEED IN HCC

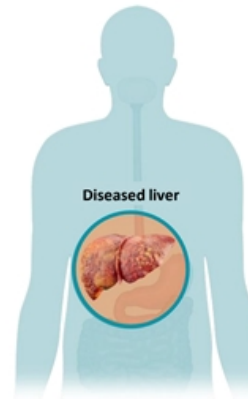

Sixth most commonly diagnosed cancer globally

Death rate increasing in the U.S. from 2000-2016

SENTI'S CAR-NK CELLS WITH MULTI-ARMING AND REGULATORY DIAL GENE CIRCUITS HAVE THE POTENTIAL TO OVERCOME SOLID TUMOR BARRIERS FOR HCC PATIENTS



SENTI-301 Aims to Safely Overcome the Immunosuppressive Tumor Micro-Environment for Patients with R/R HCC

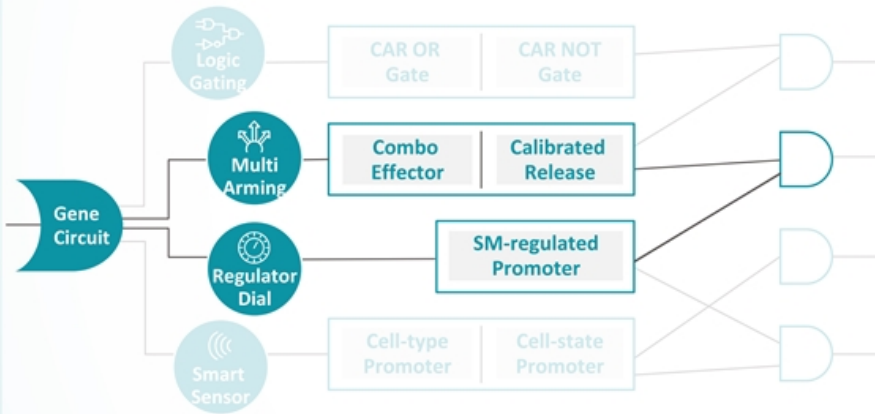

PRODUCT SCHEMATIC

GPC3 CAR-NK + Regulated, Multi Arming

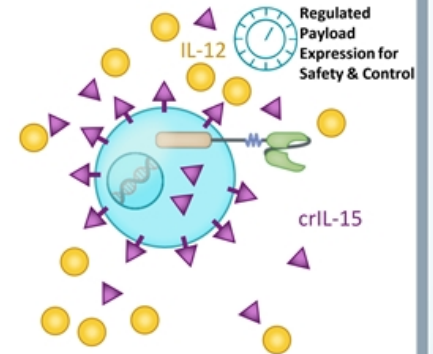

Allogeneic SENTI Regulated, Multi-Armed CAR-NK Cells



SENTI-301 Multi-Arming Approach is Designed to Attack Cancer in Multiple Complementary Ways

DIRECT KILLING

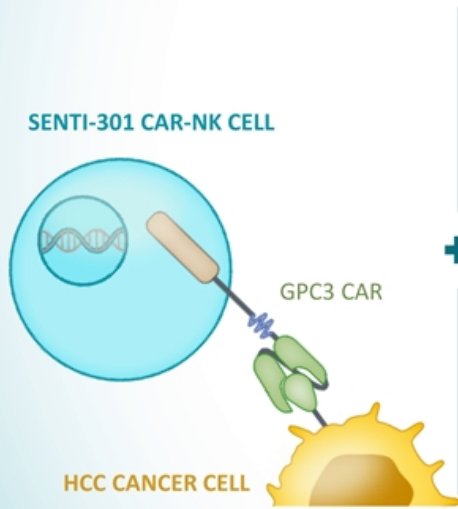

IMPROVE CAR-NK PERSISTENCE AND EFFECTOR FUNCTIONS WITH OPTIMIZED crIL-15 SIGNALING

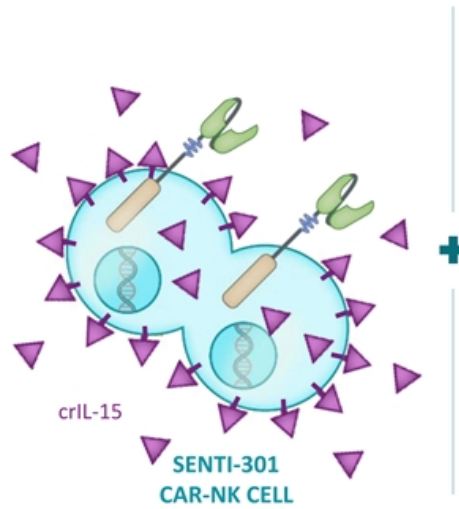

IMMUNE CELL RECRUITMENT AND TUMOR KILLING

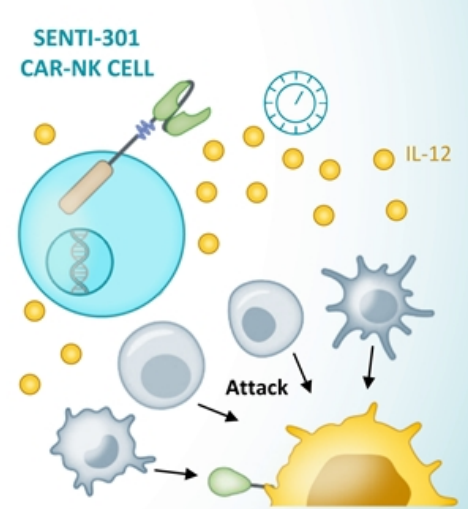



SENTI-301 Cancer Killing Demonstrates Multi-Arming and Regulator Dial Approaches Confirmed with Preclinical Studies

IMPROVE CAR-NK PERSISTENCE AND EFFECTOR FUNCTIONS WITH OPTIMIZED crIL-15 SIGNALING

IMMUNE CELL RECRUITMENT AND TUMOR KILLING

DIRECT KILLING

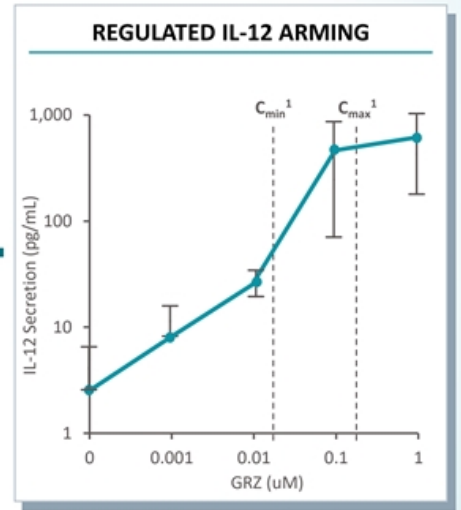
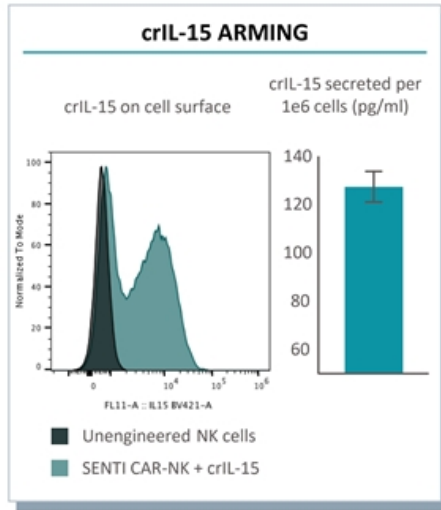
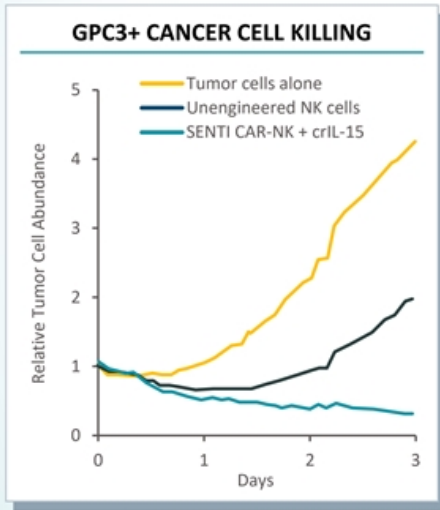

Source: Internal data
¹ Serum Cmin and Cmax of GRZ in human



Senti's Allogeneic Manufacturing Designed to Enable Widespread Distribution

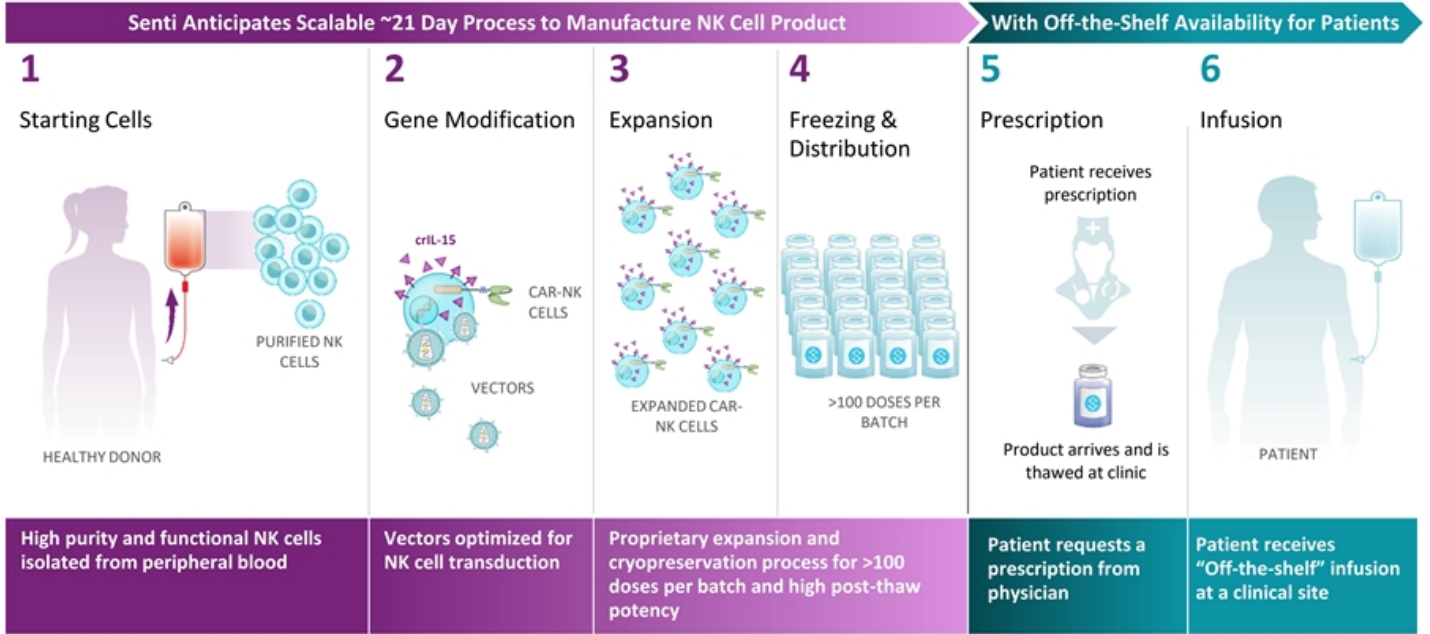



Strategy to Build, Control, and Scale In-House GMP Allogeneic Cell Manufacturing

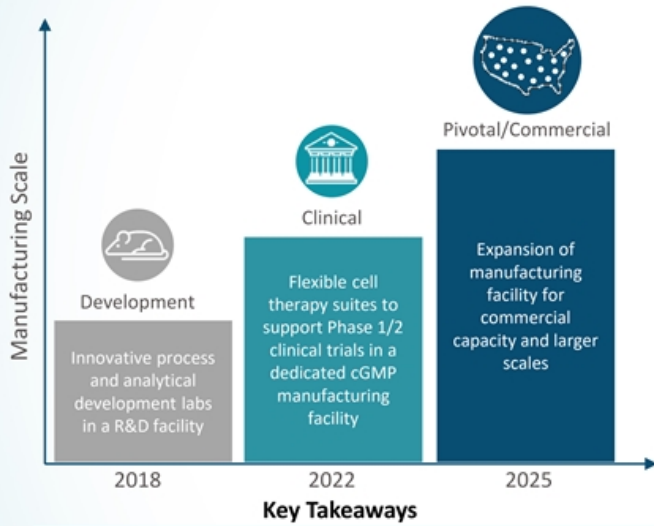

- Senti plans to operate in-house facilities and develop proprietary processes for manufacturing and testing of CAR-NK cell therapies
- Industry-leading contract manufacturing and testing partners leveraged for standardized components

Clinical / Pivotal / Commercial



GMP manufacturing, product testing, and storage (~92,000 sf) - Alameda, CA

Development



Multi-modal preclinical research labs (~40,000 sf) - South San Francisco, CA



Senti May Seek to Leverage its GMP Facility to Expand Synthetic Biology Enabled Biomanufacturing Through a Partnership

ILLUSTRATIVE BIOMANUFACTURING DEAL STRUCTURE

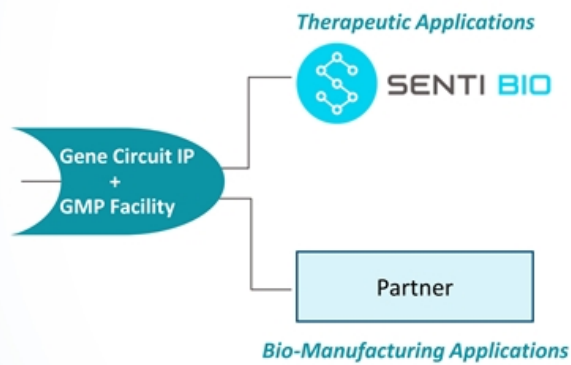

Senti Gets:

- Operational control of part of the GMP facility for its use
- Expansion of Gene Circuits to biomanufacturing applications
- Operational and financial support from Partner

Partner Gets:

- Ability to operate part of the GMP facility for contract manufacturing
- License to Gene Circuit IP only for use in biomanufacturing
- Services Agreement with Senti



Today's Cell Therapies Cannot Resolve Key Cancer Challenges

CAPABILITIES	CURRENT AUTO T CELLS	CURRENT ALLO T CELLS	CURRENT ALLO NK CELLS	SENTI'S GENE CIRCUIT ENHANCED ALLO NK CELLS
POTENTIAL FOR OFF-THE-SHELF ADMINISTRATION WITH BROAD PATIENT ACCESSIBILITY	✗	✓	✓	✓
ENGINEERED WITH AUTOCRINE & PARACRINE SIGNALING FOR ENHANCED ACTIVITY	✗	✗	✗	✓
DESIGNED WITH LOGIC GATES TO ACHIEVE ENHANCED SPECIFICITY	⊖ / ⊕	✗	✗	✓
ARMED WITH MULTIPLE MODES OF ACTION TO IMPROVE EFFICACY	⊖ / ⊕	⊖ / ⊕	⊖ / ⊕	✓
ENABLES CONTROL AND REGULATION OF PRODUCT AFTER TREATMENT	⊖ / ⊕	✗	✗	✓



Spark Therapeutics Collaboration Will Leverage Smart Sensor Gene Circuit Technology to Develop Potential Next-Generation Precision Gene Therapies

ILLUSTRATIVE PRODUCT SCHEMATIC

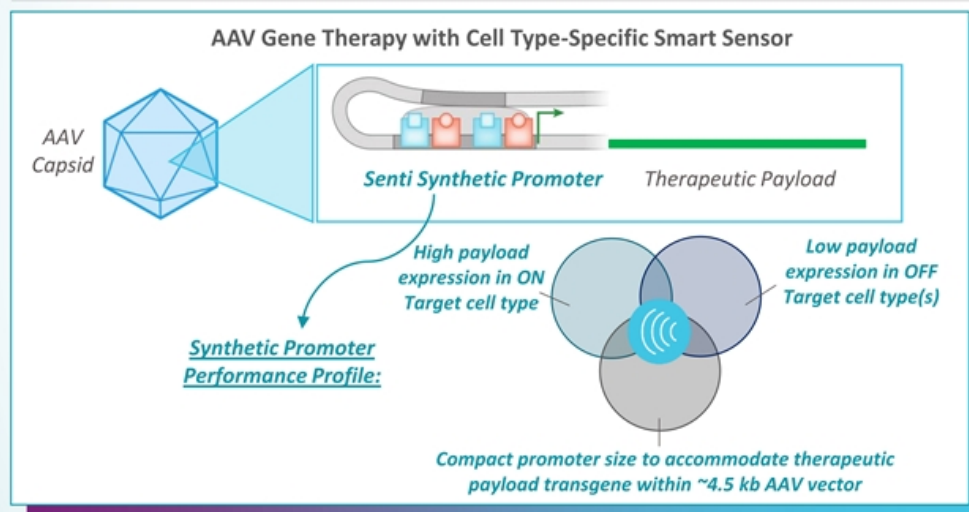

DEAL SUMMARY

- **Collaboration & option:** Senti will design, build and test cell-specific and disease-specific Smart Sensor synthetic promoters for use in Spark's next-gen gene therapy products, with Spark having the option to exclusively license such promoters
- **Field:** Certain indications pertaining to CNS-, eye- or liver-targeted gene therapy products
- **Economics:** Aggregate potential value of upfront, opt-in, development, regulatory and sales milestone payments may exceed \$645M, not including research funding and royalties on a per product basis



Senti Entered Into a Collaboration with BlueRock Therapeutics to Develop Potential Next-Generation Regenerative Medicines

ILLUSTRATIVE PRODUCT SCHEMATIC

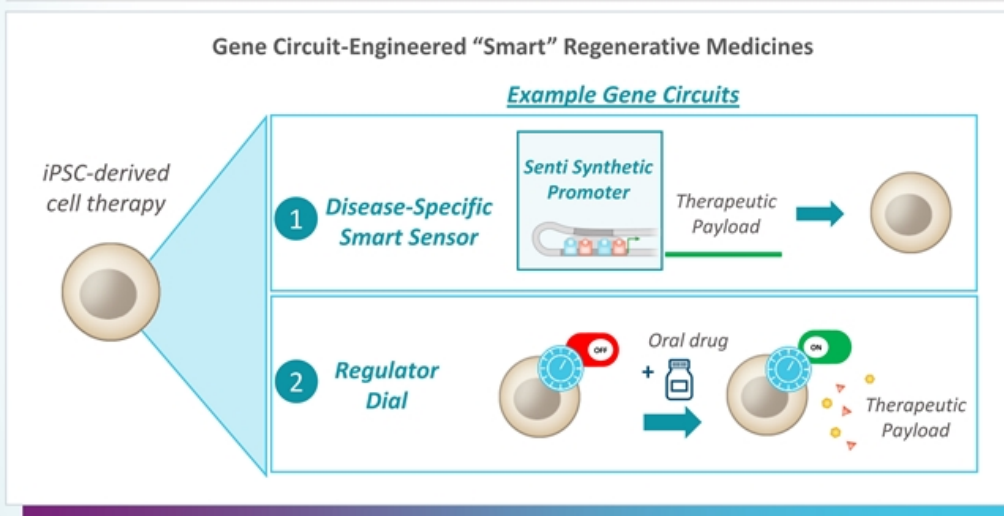

DEAL SUMMARY

- Collaboration & Option:** Senti will design, build, and test cell state- and disease- specific Smart Sensors and Regulator Dials for use in BlueRock Therapeutics' regenerative medicine product candidates, with BlueRock having the option to negotiate and enter into an exclusive or non-exclusive license in respect of such Smart Sensors and Regulator Dials
- Field:** Specified indications including but not limited to neurology, cardiology and immunology within the field of regenerative medicine, depending on the gene circuit and cell types
- Economics:** Not disclosed

*BlueRock collaboration announced May 2021



Over \$290mm of Gross Proceeds in Combined SPAC and PIPE Financing

Multiple Key Milestones Expected to be Achievable Into 2025

- Present SENTI-301, SENTI-202, and SENTI-401 IND-enabling pharmacological data at key scientific conferences (AACR, ASGCT, SITC or equivalent)
- Complete first stage of construction for clinical-scale GMP facility
- File INDs for SENTI-202, SENTI-301, and SENTI-401
- Pre-clinical POC for additional CAR-NK pipeline programs
- Clinical POC for SENTI-301
- Clinical POC for SENTI-202
- First patient dosed for SENTI-401
- Initiate final stage of construction for commercial-scale manufacturing facility
- File approximately one additional IND per year after the above three programs

Pro Forma Cash of \$326M Provides Runway Into 2025

SPAC Cash in Trust ³	\$230.0
PIPE Capital	66.8
Cash from Target Balance Sheet ^{1,2,4}	50.0
Cash from SPAC Working Capital ⁵	0.5
Illustrative Fees & Expenses ⁶	(21.7)
Estimated pro-forma cash	\$325.6

¹ No debt, no warrants; ² 2019, 2020 PCAOB audits completed to date, and quarterly reviews in 2021 by KPMG; ³ Assumes no redemptions from SPAC trust; ⁴ Based on projected cash balances of the Target as of December 31, 2021; ⁵ Based on projected cash balance of the SPAC held outside of the trust account as of December 31, 2021; ⁶ Includes an estimate of fees from the M&A and PIPE transactions, deferred underwriting fees and legal and accounting costs



YTD Progress Sets The Stage For Upcoming Value Driving Milestones

2021 YTD Achievements

Data readouts:

- Presented pre-clinical POC data at AACR, demonstrating proprietary antigen discovery platform and NOT Logic Gate functionality
- Presented preclinical data at ASGCT for SENTI-202 and SENTI-301
 - SENTI-202: Demonstrated AML antigen-specific OR Gate and NOT Gate efficacies
 - SENTI-301: Demonstrated use of Regulator Dial gene circuit for *in vivo* control of IL-12 expression

Manufacturing:

- ISCT and CAR-TCR Summit presentations demonstrating a GMP relevant allogeneic CAR-NK process

Business development and financial:

- Signed collaborations with Spark and BlueRock
- Raised \$105mm Series B round

Anticipated 2022 Milestones

- Present SENTI-301 and SENTI-202 IND-enabling pharmacological data at key scientific conferences (AACR, ASGCT, SITC or equivalent)
- Pre-IND meetings for SENTI-301 and SENTI-202
- Apply for Orphan Drug Designation for SENTI-301 and SENTI-202
- Initiate preclinical work on additional CAR-NK pipeline programs
- Complete first stage of construction for clinical-scale GMP facility
- Present clinical-scale GMP manufacturing process for gene-circuit-engineered NK cells at key technical conferences

Anticipated 2023 Milestones

- File INDs for SENTI-301 and SENTI-202
- Present SENTI-401 IND-enabling pharmacological data at key scientific conferences (AACR, ASGCT, SITC or equivalent)
- Pre-IND meeting for SENTI-401
- Pre-clinical POCs for additional pipeline candidates
- Present further platform validating data in gene therapy

Anticipated 2024+

- Approximately one IND per year



Industry-leading Management with Top-tier Board, Scientific Advisors and Investors

EXECUTIVE TEAM¹

Tim Lu, M.D., Ph.D.
CEO & CO-FOUNDER



Philip Lee, Ph.D.
CTO & CO-FOUNDER



Curt Herberts, M.B.S.
COO

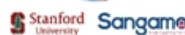

Deb Knobelman, Ph.D.
CFO



Jose Iglesias, M.D.
CHIEF MEDICAL ADVISOR



BOARD OF DIRECTORS

Susan Berland	Senior Financial Executive
Lee Cooper, J.D., MBA	LEAPS by Bayer
Brenda Cooperstone, M.D.	Pfizer Rare Disease
Ran Geng	Matrix (OrbiMed)
Alex Kolicich	8VC
Ed Mathers	NEA
Tim Lu M.D., Ph.D.	CEO & Co-Founder

SCIENTIFIC ADVISORS

Jim Collins, Ph.D (Chair)	MIT
Michael Andreeff, M.D., Ph.D.	MD Anderson Cancer Center
Lawrence Fong, Ph.D.	UCSF
Martin Fussenegger, Ph.D.	ETH Zurich
Michael Kalos, Ph.D.	Arsenal, Janssen, Lilly
Ahmad (Mo) Khalil, Ph.D	Boston University
Robin Taylor, Ph.D., MBA	SeaGen, Genentech
Michael Varney, Ph.D.	Erasca, Genentech
Wilson Wong, Ph.D.	Boston University

















SELECT INVESTORS

~\$158mm
in capital raised
to-date

Note: ¹ Gary Lee, who has served as our Chief Scientific Officer since October 2018, has informed us that he intends to leave the Company in the first quarter of 2022



Dynamics is Led by an Experienced Team with a Track Record of Success

Executive	Experience	Background
 <p>Omid Farokhzad Executive Chair</p>		<ul style="list-style-type: none"> ○ Founder, Chair, and CEO of Seer in 2017, advancing a transformative proteomics platform ○ Previously co-founded Selecta Biosciences, Tarveda Therapeutics, and BIND Therapeutics (acquired by Pfizer)
 <p>Mostafa Ronaghi Chief Executive Officer</p>		<ul style="list-style-type: none"> ○ Previously CTO at Illumina (2008-2021), and co-founded GRAIL and the Illumina Accelerator Program ○ Currently serves as a Board Member for Seer, 1Health and Clearlabs
 <p>Mark Afrasiabi Chief Financial Officer</p>		<ul style="list-style-type: none"> ○ Previously partner at Silver Rock Financial, (~\$3bn AUM), covering healthcare from 2010-2021 ○ High-Yield Research Analyst and Portfolio Manager at PIMCO prior to joining Silver Rock
 <p>Rowan Chapman Chief Business Officer</p>		<ul style="list-style-type: none"> ○ Currently serves as an independent director at Evidation Health and Natera ○ Previously regional Head of Johnson & Johnson Innovation and global Head of Healthcare Investing at GE
 <p>David Epstein Independent Director</p>		<ul style="list-style-type: none"> ○ Serves as Chair of Rubius, EVELO and Axcella, and Executive Partner at Flagship ○ From 2010 to mid-2016, served as CEO of Novartis Pharmaceuticals (division of Novartis)
 <p>Jay Flatley Independent Director</p>		<ul style="list-style-type: none"> ○ Led Illumina as CEO from 1999 to 2016 before serving as Executive Chair and later Chair of the Board ○ Currently serves on the Board of Directors of Coherent and Denali Therapeutics
 <p>Deep Nishar Independent Director</p>		<ul style="list-style-type: none"> ○ Currently Senior Managing Partner of the Softbank Vision Fund; serves on Boards of Seer, Relay and Vir ○ Previously an executive at LinkedIn and Google
 <p>Robert Langer Chief Scientific Advisor</p>		<ul style="list-style-type: none"> ○ David H. Koch Institute Professor at MIT and co-founded more than 30 companies, including Moderna ○ Received over 220 major awards and is one of 5 living individuals to have received both the United States National Medal of Science (2006) and the United States National Medal of Technology and Innovation (2011)



A Compelling Transaction for All Stakeholders

→ Exposure to new class of biotech with a novel modality-agnostic drug development platform backed by groundbreaking science

→ SPAC + PIPE firepower enables multi-year runway through clinical POC

Sources and Uses (\$mm)

Sources	
SPAC Cash in Trust ²	\$230.0
PIPE Capital	66.8
Cash from Target Balance Sheet ³	50.0
Cash from SPAC Working Capital ⁴	0.5
Target Rollover Equity ⁵	240.0
Total Sources	\$587.3

Uses	
Target Rollover Equity	\$240.0
Cash to BS / Primary Proceeds	325.6
Illustrative Fees & Expenses ⁶	21.7
Total Uses	\$587.3

Additional Transaction Details

- 100% rollover by target equity holders
- Pro-forma equity value of \$601mm and enterprise value of \$276mm
- Incremental Target equity holder earn-out of 2mm shares
- \$86.9mm of the SPAC trust committed to non-redemption agreements
- \$66.8mm fully committed PIPE
- Transaction expected to close in Q2 of 2022, subject to customary closing conditions

Pro-forma Valuation¹

\$mm, except per share data

Share price	\$10.00
Pro-forma shares outstanding	60.1
Negotiated Pro-forma Equity Value	\$601
(+) Standalone debt	
(-) Cash to BS / Primary Proceeds	(326)
Pro-forma Enterprise Value	\$276

Illustrative Pro-forma Ownership⁷

Assumes \$10.00 share price

- Existing Target Holders⁵
- SPAC Public⁸
- PIPE Investors
- Founder Shares⁹
- SPAC Private Placement Shares

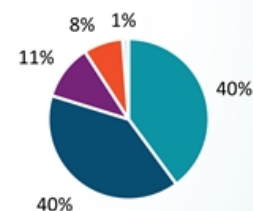

¹ Assumes no redemptions and net of estimated transaction expenses; ² Assumes no SPAC trust redemptions; ³ Based on projected cash balances of the Target as of December 31, 2021; ⁴ Based on projected cash balance of the SPAC held outside of the trust account as of December 31 2021; ⁵ Includes all holders of outstanding convertible notes and outstanding equity awards of the Target, whether vested or unvested, on an as-converted or net exercise basis at \$10/share exercise price, as applicable; ⁶ Includes an estimate of fees from the M&A and PIPE transactions, deferred underwriting fees and legal and accounting costs; ⁷ Pro-forma ownership assumes no redemptions, \$66.8mm PIPE and excludes impact of earn-out to existing Target equity holders, with 1mm shares vesting if the stock reaches \$15 (in the first 2 years from the Closing) and 1mm shares vesting at \$20 per share (in the first 3 years from the Closing), and go-forward equity incentive programs contemplated to represent approximately 22% of the pro-forma equity of the combined company via stock options with customary vesting (including 15% to be issued with a \$10/share exercise price pursuant to option grants made in connection with the transactions, and 7% reserved for future issuance); ⁸ Excludes 965,728 shares of SPAC common stock expected to be issued to SPAC shareholders entering into non-redemption agreements covering \$86.9 million of the SPAC trust; ⁹ Includes 965,728 founder shares expected to be forfeited at the closing to support the SPAC in securing non-redemption commitments



Closing Remarks

Senti is the **pioneer in therapeutic synthetic biology**



Our gene circuits are **biological software** that are designed to power **next-gen cell and gene therapies**



Senti's **deep differentiated allogeneic CAR-NK pipeline** has the potential to address key unmet needs in cancer, including SENTI-202 for AML, SENTI-301 for HCC, and SENTI-401 for CRC



Collaborations with global leaders in gene and cell therapy, Spark (Roche) and BlueRock (Bayer), indicate the broad potential of the platform



Following a **combination with Dynamics**, Senti expects to be financially positioned to become a clinical-stage platform company **delivering multiple intelligent cell and gene therapies** to patients





SENTI BIO

Appendix



Senti is Founded by a World Class Team and Supported by an Advisory Board of Pioneers in Cell and Gene Therapy

SENTI "SYNTHETIC BIOLOGY" ADVISORS

Jim Collins, Ph.D.

PROFESSOR, MIT

Scientific Co-Founder and SAB Chairperson

WYSS INSTITUTE



Wilson Wong, Ph.D.

PROFESSOR, BOSTON UNIV.

Scientific Co-Founder



Ahmad (Mo) Khalil, Ph.D.

PROFESSOR, BOSTON UNIV.

Technical Advisor



Martin Fussenegger, Ph.D.

PROFESSOR, ETH ZÜRICH

Technical Advisor



SENTI "CLINICAL AND COMMERCIAL" ADVISORS

Michael Varney, PhD

CHAIR OF R&D, SAB MEMBER AND BOARD DIRECTOR AT ERASCA

Former Head of gRED at Genentech



Michael Kalos, PhD

INDEPENDENT ADVISOR AND CONSULTANT

Fmr. Sr. Leadership at Arsenal, Janssen, Lilly



Lawrence Fong, M.D.

EFIM GUZIK DISTINGUISHED PROFESSOR IN CANCER BIOLOGY, UCSF



Michael Andreeff, M.D., PhD.

PROFESSOR OF MEDICINE, AND PAUL AND MARY HAAS CHAIR IN GENETICS, MD ANDERSON CANCER CENTER



Robin Taylor, Ph.D., M.B.A.

OWNER, TAYLOR GLOBAL BIOPHARMA CONSULTING
Fmr. Chief Commercial Officer at SeaGen



REPRESENTATIVE PUBLICATIONS IN

nature

nature
biotechnology

Science

nature
chemical biology

Cell

PNAS

nature
COMMUNICATIONS

Science
Translational
Medicine



Multiple Potential NK Cell Sources Are Available for Clinical Application

Cell Source	iPSC	Cord Blood	Peripheral Blood
Supply Chain	Requires generation of GMP iPSC bank(s) from qualified donor(s)	A few established cord blood banks with experience in CAR cell therapy	Multiple clinical networks for qualified donors with extensive use in CAR cell therapy
Genetic Engineering	iPSC engineering and clone selection with extensive pre-clinical characterization	Well-established protocols for conventional genetic engineering	Well-established protocols for conventional genetic engineering
Potency and Function	Unclear if identical to primary NK cells	More immature repertoire of NK cells	Full repertoire of functional and mature NK cells
NK Cell Expandability	Similar expandability to cord blood and peripheral blood	Increased expansion potential but smaller number of starting cells	Established methods for 1,000-10,000-fold expansion in 21 days
GMP Process Maturity	More complex, multistage process	Established unit operations for clinical process	Well-established with similarity to commercial CAR-T process
Clinical Experience	Limited clinical experience with only 4 clinical trials using iPSC-derived NK cells	Modest clinical experience with 30+ clinical trials using cord-derived NK cells	Widely used NK cell source in clinical trials with 200+ clinical trials using peripheral NK cells

PERIPHERAL BLOOD-SOURCED NK CELLS WILL ALLOW US TO IMMEDIATELY LEVERAGE AN ESTABLISHED SUPPLY CHAIN, A MATURE GMP PROCESS, AND EXTENSIVE CLINICAL EXPERIENCE TO DEVELOP OUR NEXT-GENERATION CAR-NK CELL THERAPIES



Robust Manufacturing Process Designed to Support All Internal Programs with GMP Production of Allogeneic CAR-NK Cells Engineered with Proprietary crIL-15¹

EXPANSION

Greater than 6,000-fold expansion in 21 days from frozen isolated NK cells using GMP-ready process

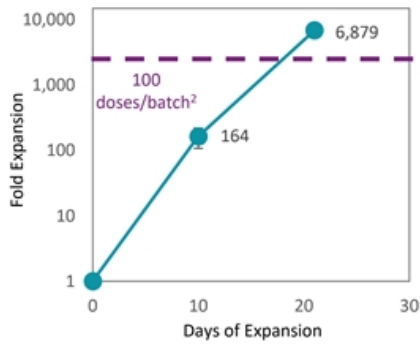

CRYOPRESERVATION

Pre-freeze and post-thaw cells have similar cell viability, CAR expression, and NK cell purity

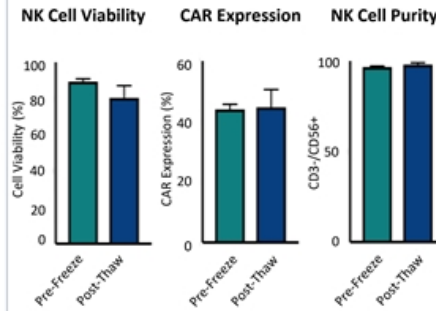

PERSISTENCE

Senti's proprietary crIL-15 enhances NK cell killing and persistence

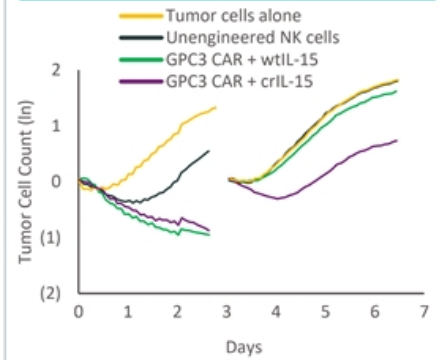

1 Calibrated release IL-15 (crIL-15)

2 Based on 3x10⁸ CAR-NK Cells per dose at anticipated clinical scale



Senti Developed a Powerful Tumor-Associated Antigen and Safety Antigen Paired Discovery Platform to Generate Targets for New Logic-Gated CAR-NK Candidates

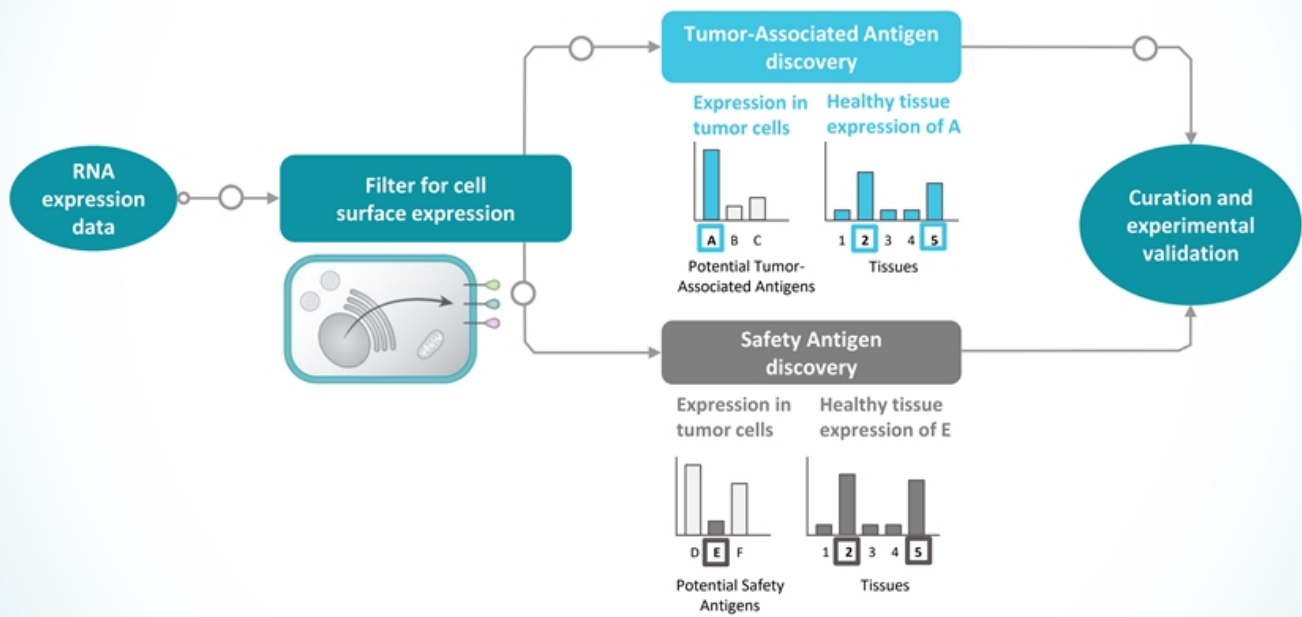

Source: Internal data



SENTI-202 NOT GATE Safety Antigen Candidates Were Identified Through Senti's Bioinformatics Approach

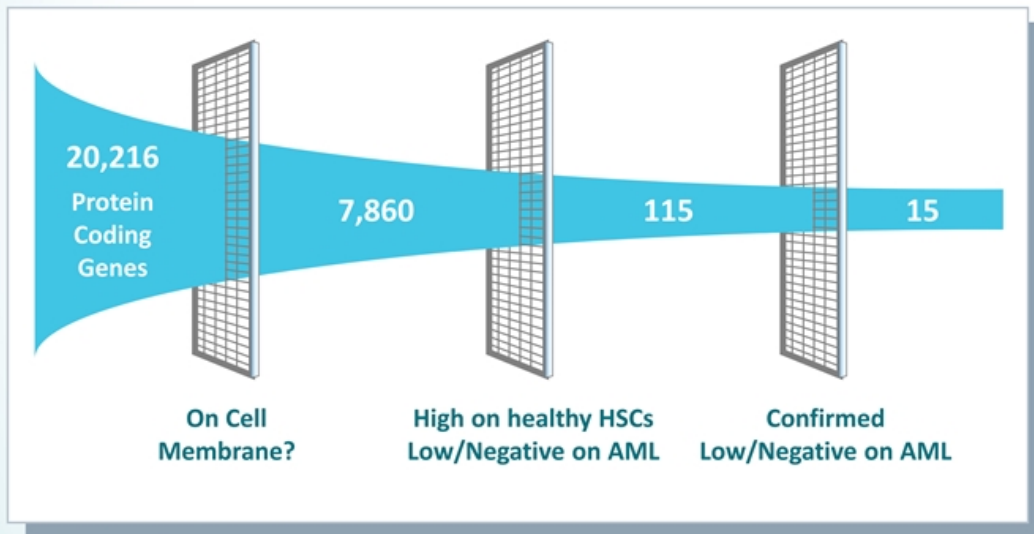

SHORT LIST OF TARGET SAFETY ANTIGENS

1. Antigen 1

2. Antigen 2

3. Antigen 3





Senti Identified a NOT GATE Safety Antigen Called EMCN That Distinguishes AML LSCs From Healthy HSCs

HEALTHY HSCs (FROM HEALTHY DONOR)

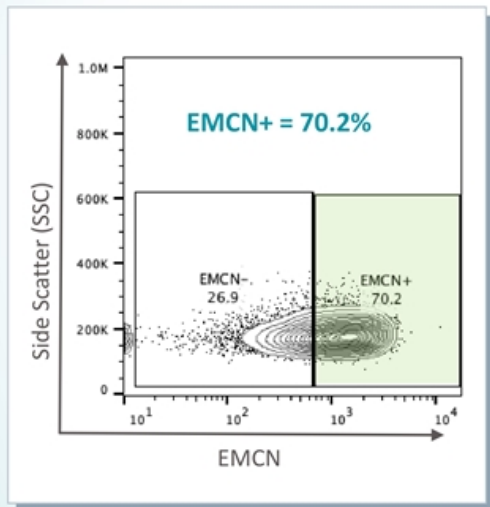

AML LSCs (FROM AML PATIENT)

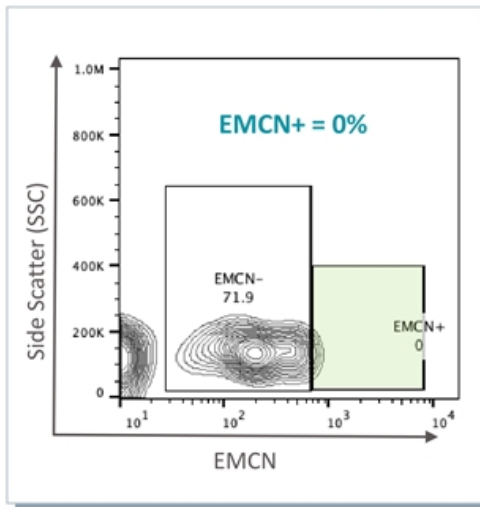

KEY TAKEAWAYS

- The 'NOT GATE' uses EMCN as a Safety Antigen input to differentiate between healthy HSCs and AML cancer cells
- This enables targeted killing of cancer cells while sparing healthy HSCs, thereby improving the therapeutic window

Source: Internal data



SENTI-401: Addressing Unmet Needs in the Treatment of Colorectal Cancer (CRC)

Toolbox of Gene Circuits

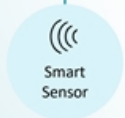

SENTI'S LOGIC GATES SOLVE KEY DISEASE CHALLENGES IN CRC

Challenges	Senti Gene Circuit Solutions
<p>Target heterogeneity Off-tumor tox limits efficacy of CEA-targeted therapies</p>	<p>NOT Logic Gate Targets the TAA CEA and prevents toxicities against healthy lung and GI tissues</p>
<p>Disease evasion Suppressive tumor microenvironment (TME) limits efficacy</p>	<p>Multi Arming Targets multiple pathways with potent immuno-stimulators to overcome TME</p>

UNMET NEED IN CRC

Previous CEA therapies resulted in on-target/off-tissue cell killing in the GI tract¹ and lung²

Pre-treatment

Post-treatment

Difficult to target CEA due to off-tumor expression

SENTI'S LOGIC GATES MAY MITIGATE OFF-TUMOR TOXICITY WHILE MULTI-ARMING MAY OVERCOME THE SUPPRESSIVE TME TO ENHANCE CRC TREATMENT EFFICACY AND PRECISION

¹ Parkhurst, et al. Mol Therapeutics. 2011.; ² Thistlethwaite FC, et al. Cancer Immunol Immunother. 2017



SENTI CAR-NK Cells Efficiently Kill CEA+ CRC cells

CEA-CAR EXPRESSION

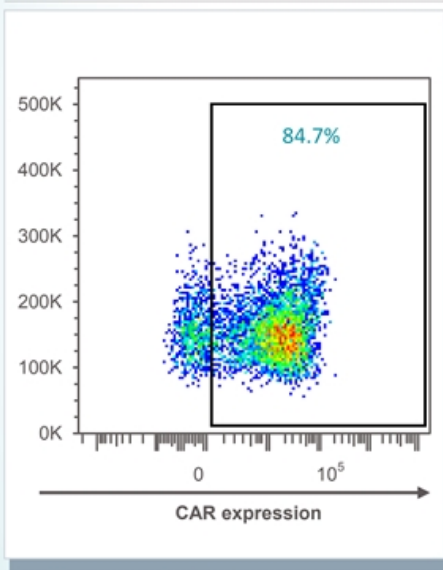

CRC CANCER CELL KILLING

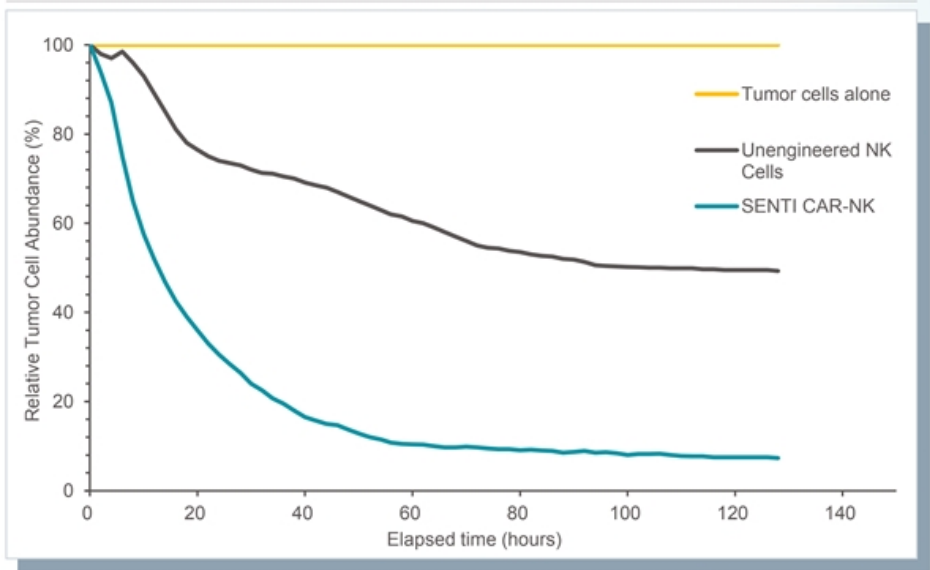

Source: Internal data



Senti Discovered VSIG2 as a Safety Antigen that is Highly Expressed in Healthy Epithelial Cells, but not in CRC Tumor Cells

TUMOR-ASSOCIATED ANTIGEN: CEA

SAFETY ANTIGEN: VSIG2

HEALTHY COLON

COLORECTAL TUMOR

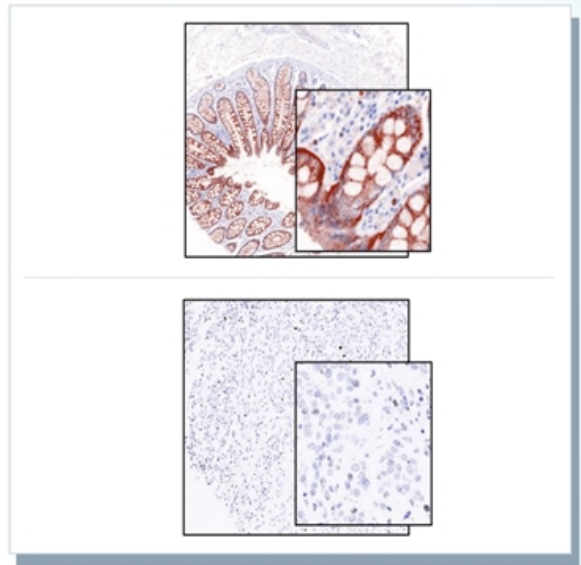
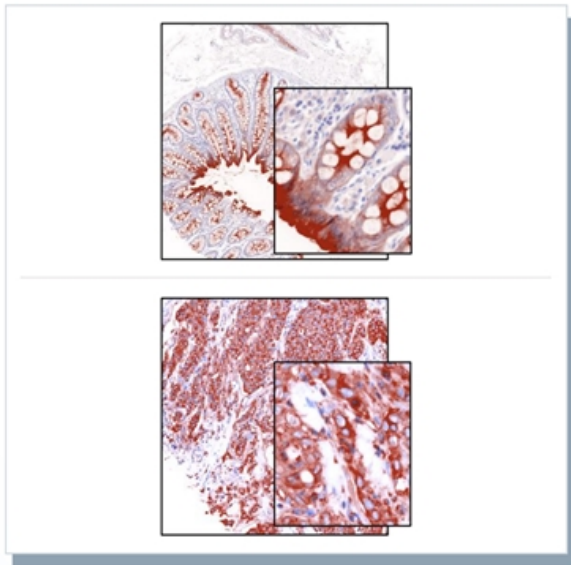

Source: Internal data

**Dynamics Special
Purpose Corp. and Senti
Biosciences, Inc. Merger
Transcript**

Transcribed By:

FINSIGHT
530 7th Avenue
New York, NY 10018

DISCLAIMER:

FINSIGHT makes every effort to ensure an accurate transcription. Enclosed is the output of transcribing from an audio recording. Although the transcription is largely accurate, in some cases, it may be incomplete or inaccurate due to inaudible passages or transcription errors. This transcript is provided as an aid to understanding but should not be treated as an authoritative record. FINSIGHT makes no representations or warranties to the accuracy and completeness of this transcript.

Omid Farokhzad:

Hello, everyone, and thanks so much for joining us today. I'm Omid Farokhzad and I serve as Executive Chair of Dynamics Special Purpose Corp. I'm also CEO and chair of Seer, a publicly traded proteomics company, which I founded in 2017 and took public in December of 2020.

I have been a serial founder and builder of multiple companies, including several that have gone public. By nature of my career, I've developed an extensive network within the academic, scientific, finance and investor communities with a unique ability to really see the world from a founder and CEO's eyes.

Before Seer, I was a professor at Harvard Medical School and directed the Center for NanoMedicine at the Brigham and Women's Hospital. Our CEO Mostafa Ronaghi will walk you through the rest of the Dynamics team later in the presentation.

Our team has identified Senti as the ideal partner for Dynamics and we're very excited to share with you our enthusiasm for this deal. When we started our SPAC, the overarching hypothesis was that the collection of entrepreneurs, operators and investors that came together could create a highly differentiated SPAC capable of finding a disruptive platform with a world-class management team where the value proposition would be unique to investors. And today we believe that hypothesis has been validated.

Senti is creating the next generation of smart medicines powered by proprietary gene circuit technology. The Senti founders are pioneers of mammalian synthetic biology, having made some of the seminal discoveries over the past 20 years. They have pulled together a strong management team with a singular mission to launch first-in-class cell and gene therapies that are powered by gene circuits to give unprecedented control over the intended cellular response and therapeutic benefit.

We see the potential of Senti defining the cell and gene therapies of the future, including addressing some of the challenges that have plagued the first-generation technologies, such as addressing solid tumors and expanding to therapeutic areas beyond oncology. We believe this is a compelling opportunity for all parties, offering exposure to a disruptive technology platform and a rich pipeline to produce multiple products over the years to come.

The proposed transaction will deliver significant proceeds to Senti to support their growth strategy and allow investors access to a wide array of future catalysts and value creating events going forward. The Senti team shares our vision that an important part of success is having world-class investors as your partners to build a great organization.

This deal is designed to attract the best investors with a long-term mindset in building a great company. At Seer this was always my strategy, and I've always optimized foremost to attract the right people around the table. Dynamics has brought top tier institutional investors to support the transaction, alongside Senti's existing shareholders to establish a very strong shareholder base and provide the company with the growth capital. The capital provides significant runway to continue advancing its technology while establishing and controlling manufacturing processes and advancing the preclinical work to enable a broad and diverse pipeline.

I plan to remain involved post-closing as a board member alongside with David Epstein, who's currently one of Dynamics' three independent directors. David has more than 25 years of extensive drug development, deal making, commercialization and leadership experience on a global scale, including in the cell therapy space. Now let me turn it to Tim and his team to walk you through the Senti story.

Tim Lu:

Thank you, Omid. On behalf of the Senti team, I want to thank you for your confidence in our vision, team and growth. I also want to thank our new and current investors. Your support will propel our vision at Senti, which is to create intelligent medicines using synthetic biology, so that they can sense, compute and outsmart diseases for patients in need.

This vision has been a personal passion of mine for the last 20 years. I did my MD and PhD at MIT and Harvard in synthetic biology, and worked with pioneers in biotech, such as Bob Langer and Jim Collins. I ended up joining the MIT biological engineering, electrical engineering, and computer science faculty in 2010, where I became tenured. After many years of working to apply synthetic biology to the cell and gene therapy space, I launched Senti together with Philip Lee and our scientific co-founders to make these products a reality for patients.

[SLIDE 2]

This slide has our standard disclaimers.

[SLIDE 3]

Philip and I started Senti after seeing the impact of first-generation CAR-T and first-generation AAV gene therapies in the clinic. What we realized was that despite their potential, these products were still incredibly limited by the simple genetic engineering inside.

Today, we can overcome these problems by using synthetic biology, data and computation to program intelligent cell and gene therapies and instruct them to treat diseases in more targeted, controlled and effective ways. To do this, Senti has created a powerful technology stack, by designing what are called gene circuits.

Gene circuits are biological software, coded in the form of DNA that reprogram living cells to sense, compute, and respond. These gene circuits have broad applications and can power multiple therapeutic modalities, including NK cells, T cells, iPSCs, gene therapies and others. And we've generated data in many disease indications using this technology, including oncology, immunology, and beyond.

We have focused our internal product pipeline on next-generation allogeneic CAR-NK cells to solve key issues in cancer, not addressed by current approaches. To accelerate these products into patients, we're building a fully integrated biotech company with internal R&D, process development, manufacturing and ultimately clinical experience.

We anticipate IND filings for our CAR-NK programs in 2023, focused on SENTI-202 for AML, and SENTI-301 for liver cancer. It's our goal to use this engine to pursue approximately one IND per year beyond that. This includes SENTI-401 for colorectal cancer and other liquid and solid tumors as well.

Our engine has numerous opportunities outside of oncology, as demonstrated by our partnerships with Spark/Roche in certain gene therapy applications and with BlueRock/Bayer in regenerative medicine.

[SLIDE 4]

From the start, Phillip and I have been focused on building a world-class team at Senti, to be the leader in the therapeutic synthetic biology space. Our co-founders and broader scientific advisory board have pioneered this space, having published many of the key papers over the last twenty years. Collectively, our team has started and supported many biotech companies, including multiple public ones.

Jim Collins, one of our co-founders, published one of the first synthetic biology papers, where he described a switch for toggling genes on and off in cells. Jim is a member of all three National Academies and continues to be one of the most highly cited scientists in the field, and a great collaborator with Senti. We also work very closely with co-founder Wilson Wong, who has pioneered the application of synthetic biology to CAR-T and CAR-NK cells.

[SLIDE 5]

Cell and gene therapies have already begun to transform the lives of patients suffering from previously incurable diseases. However, current products are only applicable to a relatively small number of indications, and this is ultimately due to inherent limits in tackling 4 key disease challenges that are posed by disease biology.

First, there's an inability to precisely distinguish between diseased and healthy cells with existing drugs. And this makes it difficult to overcome the challenge of target heterogeneity. So, for example, it's difficult to find clean tumor-associated antigens that are only expressed on cancer cells and not on healthy tissues. As a result, most existing CAR-T and CAR-NK cells are directed against antigens where this lack of specificity can be tolerated, such as CD19 and BCMA, thus leading many liquid and solid tumors unaddressed.

Second, the inability of current drugs to overcome multiple disease mechanisms ultimately can lead to disease evasion. For example, solid tumors pose a major barrier for current cell and gene therapies due to multiple suppressive factors in the tumor microenvironment. And existing single target drugs, for example, a cell therapy that only contains a single CAR, cannot overcome these barriers because they don't actually act on those multiple pathways at the same time.

Third, there's a lack of regulation in existing cell and gene therapy products, which makes it difficult to overcome narrow therapeutic windows. Basically, it's challenging to control what these cell and gene therapies are doing after they've already been delivered into patients.

And finally, there's a challenge in sensing and adapting to dynamic disease conditions in the body. Many human diseases may only occur in certain cells or may change over time, and existing products are unable to respond to these conditions.

[SLIDE 6]

Our gene circuits address these 4 major problems by introducing intelligence and computation into cell and gene therapies. We do this by designing gene circuit programs in the form of DNA. These gene circuits allow us to build cells that can sense and adapt to biological signals.

There are natural gene circuits that have evolved over billions of years to give rise to all the biology around us. Here at Senti, our technology platform allows us to actually design intelligent synthetic gene circuits that actually detect when and where diseases occur, make decisions based on that information, and then respond with the desired therapeutic activities. These gene circuits can be broadly deployed as biological software against any applications.

[SLIDE 7]

Creating gene circuits is not a trivial task. We've built a world-leading engineering platform that integrates synthetic biology and technology together to ensure a high degree of optimization and to generate a broad IP estate for therapeutic gene circuits.

As an example, we use computational algorithms and machine learning to integrate big data derived from public datasets, as well as our own central knowledge database. We then use high-throughput strategies to construct libraries of gene circuits where we can vary the genetic parts and all the interconnections between them at scale.

We then have Build teams that can build the viruses and the cells that contain those gene circuits, as well as disease-specific biology teams that have detailed in vitro and in vivo assays to test and quantify the performance of these libraries. All of the data linking gene circuit sequences to functional results are ultimately stored in that central knowledge database, allowing us to learn from each round of experimentation and ultimately to create highly optimized gene circuits for downstream development. Now, this design-build-test-learn engine is useful not just to our own internal programs, but also for any of our partner programs.

And in fact, the more data we push through this engineering cycle, the deeper our central knowledge database becomes, and this is a central proprietary asset for the company.

[SLIDE 8]

We've focused our efforts on 4 key categories of gene circuits, each of which directly addresses one of those fundamental disease challenges that current products are unable to tackle.

First, to overcome target heterogeneity, our Logic Gating gene circuits can sense and respond to multiple targets rather than just relying on a single one. In essence, we're designing therapeutics that can detect a signature of disease.

Secondly, to overcome disease evasion, our Multi-Arming gene circuits can attack multiple disease mechanisms at the same time from a single product, essentially creating a single all-in-one therapeutic.

Third, to address narrow therapeutic windows, we design Regulator Dial gene circuits that allow cell and gene therapies to be controlled by FDA-approved oral drugs, even after the cell and gene therapies have already been delivered into patients.

And finally, to address dynamic disease conditions, we've created a diverse set of Smart Sensors that could detect different classes of biomarkers and thus control when and where cell and gene therapies are activated in response to disease.

[SLIDE 9]

Our gene circuit software can be mixed and matched together to power a wide range of genetic medicines. This includes NK cells, T cells, AAVs, stem cells, and also non-viral gene therapies. We've demonstrated their potential across multiple disease models.

In the following few slides, I'll give you an example of each of the major classes of gene circuits. These just highlight and scratch the surface of what's possible, so we're quite excited about the deep potential for this form of genetic software, even beyond the applications I am going to jump into now.

[SLIDE 10]

Let's start with Logic Gates. Logic Gates address the challenge of disease heterogeneity by enhancing the precision and thus efficacy of cell and gene therapies. They do this by recognizing diseased cells based on multiple targets of disease rather than just a single one. Therefore, we can create products that respond to signatures of disease overall.

One of the most impactful Logic Gates is what we call the "NOT gate". We call it the "NOT gate" because it executes the logic, "DO NOT KILL healthy cells". This is particularly valuable because there are only a few tumor-associated antigens that are actually cleanly expressed on cancer cells. Therefore, the "NOT gate" allows us to open up a much wider universe of cancer types that can be addressed.

We've built and optimized "NOT gates" in NK cells as well as T cells, and we do this by creating what we call an inhibitory CAR or iCAR.

On the left-hand side of this figure, you can see our Senti CAR-NK cells in blue. As indicated as the purple receptor on these cells, the iCAR blocks the activity of an activating CAR or aCAR, which is demonstrated by the green receptor on these cells. On the left-hand side, in the presence of the tumor-associated antigen, which is the pear-looking green symbol on the cancer cells, the activating CAR recognizes and then triggers killing of those cancer cells.

Now, if that same tumor-associated antigen in green was also expressed on healthy cells, a conventional product such as a CAR-T, a CAR-NK cell, an ADC, which rely on just recognizing and responding to a single target, would ultimately kill that healthy cell. And that would limit the therapeutic window and the efficacy of the treatment.

To overcome this problem, we designed the “NOT gate”. The “NOT gate” inhibitory CAR, as shown on the right-hand side, recognizes what we call a safety antigen, which is demonstrated as the purple pear-shaped symbol on the healthy cells. We identify these safety antigens as being highly expressed on healthy cells, but not on cancer cells. We do this using computational bioinformatics to analyze large patient datasets and then validate these in house.

Specifically, when the iCAR engages the safety antigen, it triggers a signaling cascade that prevents the killing of the healthy cells. As a result, the “NOT gate” NK cells continue to kill cancer cells that express the tumor antigen, but do not kill healthy cells expressing the safety antigen. We have designed our “NOT gate” to use protein signaling cascades to trigger the inhibitory activity, thus resulting in a response that can potentially occur much faster than alternative approaches.

[SLIDE 11]

We confirmed that the NOT gate functions in various in vitro and in vivo models. In this experiment, we injected mice with equal amounts of model healthy cells, as well as model cancer cells. We did this along with an injection of CAR-NK cells that either did not or did contain the NOT gate.

The middle graph of this slide shows the activity of the NOT gate. With the control CAR-NK cells that do not contain a specific NOT gate against the antigens here, you can see that there’s a significantly comparable level of repression of both healthy cells as well as cancer cells in the mice on the left.

Now, when we introduced our specific NOT gate, which is the data on the right-hand side of the middle graph, you can see that there’s a significant protection of the healthy cells compared to the cancer cells in this particular model.

The figure on the right-hand side looks at this in much more detail. Mice that were treated with the control CAR-NK cells had a healthy-cell-to-cancer-cell ratio of close to 50%, which is expected given that was the ratio between these cells that we actually injected into the mice in the first place. Now, when we look at the CAR-NK cells that contained the NOT gate, which is on the far right, we see a significant enrichment of healthy cells, indicating that they were actually spared from killing. This data demonstrates the functionality of the “NOT gate” in vivo, as well as the continued ability to kill cancer cells while protecting the healthy ones.

[SLIDE 12]

The second category of gene circuits is what we call Multi-Arming. These gene circuits allow us to overcome complex disease invasion mechanisms and to boost the activity of cell therapies by expressing multiple payloads from a single product.

For example, in cancer applications, we're interested to significantly increase the potency and the durability and the killing activity of our cell therapies. To do that, we built a library of engineered cells that express multiple immunostimulatory payloads, including interleukins as well as chemokines.

And then what we did was to test for their ability to enhance the killing of cancer cells in a variety of models.

[SLIDE 13]

So, for example, we have engineered CAR-NK cells that have either expressed no cytokines as you can see in the dark blue, individual cytokines, which you can see in the red or the purple, or a specific pairwise combination of cytokines, which we discovered through this process, which can be seen in the light blue.

We performed a long-term killing assay over five days using Incucyte, and we basically found that this particular pairwise combination of cytokines, when expressed by the cells, results in significantly enhanced tumor killing. This is demonstrated again by the light blue curve on the left-hand side, as well as the microscopy images on the right, where you can see the tumor cells being cleared from the culture in the lower right-hand corner.

Therefore, we believe that our Multi-Arming gene circuits have the potential to increase the durability and activity of CAR-NK cells.

[SLIDE 14]

Third, to overcome the issue of narrow therapeutic windows, we've built multiple Regulator Dial gene circuits that enable external control of cell and gene therapy after they've been delivered to the body.

These Regulator Dials can be switched off or switched on by the administration of FDA approved oral drugs such as Hepatitis C virus protease inhibitors, IMiDs, and tamoxifen.

Although this diagram shows a Regulator Dial ON switch, in which adding the drug turns the system on, we've also built other flavors of these Regulator Dials as well, including OFF switches and rheostats.

[SLIDE 15]

Here's one example of a Regulator Dial gene circuit in action. This circuit was engineered to control IL-12 secretion from a cell therapy in response to Grazoprevir, which is an FDA-approved oral Hepatitis C virus protease inhibitor.

In the presence of Grazoprevir, IL-12 is switched on and IL-12 is detectable in the mouse plasma as can be seen on day four on the left.

When Grazoprevir is withdrawn, IL-12 secretion is switched off and reverts to baseline, which can be seen in the data on the right by Day 8. This level of on/off in vivo control of IL-12 is about 90 fold in this particular assay. And to the best of our knowledge, this level of control is at least an order of magnitude better than other approaches that have been described. This is very important because it allows us to achieve very tight regulation over therapeutic activity.

[SLIDE 16]

Finally, diseases are dynamic and being able to pinpoint when and where they occur is really essential to creating safe and effective therapies. However, current cell and gene therapies are often not equipped with the sensors they need to actually detect when and where they should be active.

We've seen this to be a challenge, for example, with AAV gene therapies that use standard promoters and don't confer great selectivity. To deal with this issue, we've built a powerful approach to create Smart Sensors that detect specific disease biomarkers of interest.

On this slide, I'm showing you specifically this concept in the context of gene therapy. Here, we want to design very specific promoters that detect on-target versus off-target cells so that we can selectively activate the therapy only in specific on-target cell types. To do this, we created a powerful computational machine learning pipeline, which essentially looks at on-target versus off-target cell biology and picks out specific disease signatures, such as differentially active transcription factors.

Using our design, build, test, learn engine we can then create massive libraries of these Smart Sensor promoters, which respond to specific transcription factor signatures. Using high throughput methodologies such as next-generation sequencing, we can select the best performing promoters and use these to ultimately regulate the activity of the gene therapy in response.

[SLIDE 17]

We've now demonstrated the applicability of our Smart Sensors across a multitude of different disease models. For example, we've used this platform to create highly targeted synthetic promoters that are selectively activated in breast cancer cells but not in normal breast cells. And this is the data shown on the left.

This particular promoter on the left is over 1000-times more specifically activated in breast cancer cells versus the healthy breast control cells. Current generation "selective promoters" are maybe at most 5 or 10-fold selective. So here we're talking about several orders of magnitude of improvements over what's been described previously in the literature.

This capability will allow us to encode highly potent payloads that only have expression in the diseased cells while avoiding potential toxicity in the healthy cells. To show that this platform is generalizable, we've also used it to create promoters with the reciprocal selectivity. For example, on the right-hand side, we have a healthy cell synthetic promoter that is highly selective for healthy cells but not active in cancer cells. We've also extended this concept into many other cancer applications as well as non-cancer applications, for example, with our Spark collaboration.

[SLIDE 18]

I've shown you that our gene circuits have the potential to solve key challenges across a wide range of diseases. Using gene circuits as the core differentiator, we're building a fully owned pipeline of allogeneic CAR-NK cell therapies for oncology.

SENTI-202 specifically uses Logic Gating to treat AML.

While SENTI-401 extends the NOT Logic Gate into colorectal cancer in order to tackle the problem of target heterogeneity in that disease type.

We also have multiple discovery stage Logic Gating programs in development that demonstrate the breadth of our approach in many other solid and liquid tumors.

SENTI-301 uses our Multi-Arming gene circuit in liver cancer. This strategy can be extended also into many other solid tumors to overcome the disease evasion challenge.

For our allogeneic CAR-NK pipeline, we are doing the upstream R&D, but also investing into downstream process development, manufacturing and ultimately clinical development, in order to bring these programs into the clinic into patients.

We are targeting SENTI-202 and SENTI-301 for IND in 2023, and then approximately one IND per year afterwards. In addition to oncology, we've partnered with some of the best cell and gene therapy companies in the world to deploy gene circuits in other disease indications.

This includes working with Spark/Roche on specific Smart Sensor promoters for precision gene therapy in the eye, the CNS and the liver, and also working with BlueRock/Bayer on gene circuits for iPSC-based cell therapies for regenerative medicine applications.

We do anticipate that there will continue to be many exciting opportunities that present themselves. The field has increasingly recognized that there are many challenges with the current cell and gene therapy technologies that could be very well addressed through the use of synthetic biology.

[SLIDE 19]

Before getting into our specific programs, I want to introduce why we chose NK cells as an ideal modality for our Gene Circuits internal pipeline.

First and foremost, NK cells have been able to demonstrate that they have innate killing activity against cancer, as well as the ability to activate the broader immune system to attack tumors.

Furthermore, recent clinical studies have shown that NK cells can have substantial anti-cancer activity in humans. And yet, they have a very favorable safety profile in many cases compared to CAR-T products, with a low or no incidence of GvHD, otherwise known as Graft versus Host Disease, as well as a much lower risk of side effects, such as cytokine release syndrome, or CRS, and neurotoxicity.

Furthermore, NK cells have the potential to enable broad access for patients, since you can derive NK cells from healthy donors, expand them and freeze the product, therefore making an off-the-shelf product available.

[SLIDE 20]

We've used synthetic biology to significantly improve the potency and the ability for CAR-NK cells to kill cancer cells over time.

Specifically, we've designed what we call the calibrated release platform, which allows us to express cytokines on both the cell surface of our engineered cells in order to achieve efficient autocrine signaling, as well as to secrete these cytokines into the surrounding environment so that they can engage in efficient paracrine signaling.

We call this platform calibrated release because we could engineer these cytokines to tune the amount of cytokine that's actually on the cell surface versus being secreted.

Now the functional nature of this is that it allows us to create cytokine-optimized cells that have significantly enhanced performance in important functional killing assays against cancer.

For example, this particular experiment is over a long time period. The reason why this particular graph looks like it resets itself over 3 times is because we inject cancer cells at hour 0, hour 96, and hour 168 in order to challenge the NK cells to see how efficiently they can repeatedly kill.

You can see that on the first round of killing, all CAR-NK cells either containing our calibrated release IL-15 or the wild-type secreted IL-15 are able to achieve reasonable amounts of CAR-NK killing.

However, by the second round of killing, we can see that the SENTI CAR-NK cells, containing the calibrated release IL-15 are far superior to CAR-NK cells with the wild type IL-15 or non-engineered NK cells. This ability to serially kill cancer cells with high efficiency continues even into the third round.

So we're very excited about this platform. Given its potential to enhance the potency and the durability of CAR-NK functionality. The calibrated release platform essentially allows us to create cytokines with optimal signaling characteristics, including both self-stimulatory autocrine signaling and trans-signaling paracrine activation. We've applied this to IL-15 as shown on this slide, but we've also demonstrated that our calibrated release technology can be used to engineer other cytokines as well.

This calibrated release platform will be used in all of our programs described downstream and will serve as a fundamental baseline to enhancing our CAR-NK cell functionality.

[SLIDE 21]

Let's dive into Senti's pipeline programs.

I'm excited to talk to you today about SENTI-202, which applies to AML, because we fundamentally believe that a transformative therapy in this space is really needed.

Despite recent advances in AML treatment, the 5-year survival rate for AML remains quite low and allogeneic bone marrow transplants still remain the only potential curative treatments for many relapsed/refractory patients.

Now there are several challenges that we believe AML poses to existing drugs, really centered around the idea of target heterogeneity.

So number one, it's difficult to find a single target that's both expressed on the AML blasts as well as on the leukemic stem cells. And so with conventional single-target therapies, you can oftentimes generate relapses by incomplete clearance of the AML cancer cells.

To address this problem, we're designing what we call the OR gate. The OR gate allows us to kill any tumor cell that expresses antigen A or antigen B, essentially allowing us to target multiple tumor antigens at the same time.

The second issue is many of the targets that have been described for AML are not uniquely expressed on the AML cancer cells. They are also found in healthy tissues, and as a result, existing drugs can exhibit significant off-tumor toxicity, thus limiting efficacy due to this lack of specificity. This is where we're deploying the NOT gate, which allows us to create broad targeting of all AML cells while still preserving healthy cells, such as the blood stem cells.

With these features, we believe that SENTI-202 has the potential to offer a curative treatment for patients in the absence of a bone marrow transplant.

[SLIDE 22]

The SENTI-202 product schematic is shown on this slide.

SENTI-202 is an allogeneic off-the-shelf CAR-NK product engineered to broadly target mature AML blasts and AML leukemic stem cells using an OR gate approach. Specifically, we've designed a bivalent activating CAR, shown on the left-hand side in green, which targets two known AML tumor-associated antigens, FLT3 OR CD33. These two antigens were chosen due to the great complementarity they have with each other in covering the AML tumor cell heterogeneity that is seen across a broad set of patients.

Number two, to prevent on-target off-tumor toxicity against the healthy bone marrow, we've engineered the NOT gate, which is shown as the purple receptor on the right-hand side. This is implemented to have activity upon binding to a safety antigen called endomucin, or EMCN.

We've shown that this endomucin antigen is highly expressed on healthy hematopoietic stem cells, but minimally expressed on AML cells. This allows us to implement a NOT gate that can protect the critical hematopoietic stem cell compartment during treatment.

Finally, there's the calibrated release IL-15 I mentioned earlier, which allows us to achieve efficient autocrine and paracrine signaling of IL-15.

[SLIDE 23]

We can combine our OR gate and NOT gate technologies together into CAR-NK cells to create a potentially enhanced therapeutic for AML.

As I mentioned before, on the left-hand side, our OR gate technology allows us to target FLT3 OR CD33, which are heterogeneously expressed across the heterogeneous AML cell population. This broad targeting allows us to increase the spectrum of killing.

On the right-hand side, by recognizing and engaging endomucin as the safety antigen on healthy hematopoietic stem cells, we can actually limit the killing activity of our CAR-NK cells against the healthy bone marrow. For example, it's known that both CD33, as well as FLT3, can be expressed on healthy bone marrow cells.

One of the particular reasons we believe that AML is a great starting point for this particular product and our Logic Gate technology is that we do not need to protect 100% of the HSCs for this product to be meaningful.

Based on decades of transplant experiences, key opinion leaders believe that a target of even 10% to 20% protection of healthy hematopoietic stem cells or HSCs, should be clinically meaningful.

And the reason for this is that HSCs are able to repopulate the entire bone marrow, even if they start at relatively low numbers.

We really like AML as an indication, both in terms of significant patient need, the fit with known antigens, as well as the ability to demonstrate potentially enhanced clinical activity by protecting even just 10-20% of the healthy stem cell population.

[SLIDE 24]

We've optimized and have constructed a Senti OR-gate CAR and demonstrated its activity against AML by recognizing the FLT3 OR CD33 tumor antigens. We've shown that this technology enhances the killing of AML leukemia cell lines, as well as primary AML cells, including data that was presented earlier at ASGCT.

On this slide, we've shown that the OR-gate CAR-NK cells are highly potent against AML tumor cells in this xenograft mouse model. You can see that in row three of the groups on the left-hand side, as well as in the light blue survival curve on the right-hand side, that our OR-gate enables CAR-NK cells to achieve statistically significant greater anti-tumor activity and survival of diseased mice. We've seen this consistently hold across multiple tumor models and there are also benefits compared to CAR-NK cells that only go after a single target, which is data not shown here.

[SLIDE 25]

We've also shown that the NOT Gate recognizing endomucin is functional and can be optimized for use in the CAR-NK setting. What we show here is an endomucin-specific inhibitory CAR that's able to shut down CAR-NK killing against target cells that express that endomucin safety antigen.

As you can see here on this figure, there's three sets of data. On the left-hand side is a nonspecific control NOT gate, which does not recognize endomucin, and as you can see, as a result, there's minimal benefit of the NOT Gate in protecting the healthy target cells from being killed. Now in the middle data here, this is endomucin-iCAR version one, which actually shows pretty significant protection of those healthy cells expressing endomucin. On the right-hand side, we have iCAR version two, which again, shows significant protection. We wanted to call out two different iCAR designs here because depending on the actual context, the antigen selected, etc. in which these iCARs are being used, we can actually pull different designs and rapidly optimize any CAR-NK product for any particular antigen target combination we desire. And so, this is important for the expansion of our therapeutic pipeline, beyond just AML.

[SLIDE 26]

We've also demonstrated that the NOT Gate can function with healthy human primary cells, which is really exciting data recently presented at the ASH conference. We set out to evaluate the full SENTI-202 gene circuit, which contains all of the components, including the bivalent activating OR CAR, the endomucin inhibitory iCAR and the calibrated release IL-15. What we wanted to show is that we can prevent the killing of healthy hematopoietic stem cells derived from humans.

On the left-hand side we assessed that the NOT gate does not negatively impact tumor cell killing. As you can see in the dark blue versus the light blue, cells that contained the NOT Gate still retained highly efficient killing of AML cancer cells.

On the right-hand side, we tested healthy hematopoietic stem cells, as well as multi-potent progenitors or MPPs, derived from healthy human donors. What you can see is that the OR gate on its own, which is shown in light blue, does kill those cells in this assay. With our NOT gate, we're able to protect close to 50% of this overall healthy cell population.

To the best of our knowledge, this is one of the first demonstrations of a functioning NOT gate in CAR-NK cells. It's very exciting because this technology has the potential to spare healthy cells from being affected while still maintaining efficient cancer killing. It's also particularly exciting because we believe in AML that protecting even just 10-20% of healthy stem cells should be clinically meaningful. And thus this product profile has the potential to offer patients and significantly improve treatment even without the need of a bone marrow transplant.

[SLIDE 27]

Now switching gears, I also want to share our SENTI-301 liver cancer program. Liver cancer is a devastating disease globally, is very commonly diagnosed and is one of the major leading causes of cancer deaths. One of the big challenges in treating liver cancer especially with immunotherapy is the immunosuppressive microenvironment that allows tumors multiple ways to evade from conventional therapeutics. For SENTI-301, to overcome the disease evasion challenge, we've designed a Multi-Arming approach where we can engineer NK cells to secrete multiple cytokines, as well as to contain a liver-cancer-specific CAR. This allows us to have a multifactorial attack on the tumor microenvironment.

Arming CAR-NK cells with very potent immune effectors has the potential to increase efficacy. However, some of these immune effectors, such as IL-12, are highly potent and can generate systemic events or significant immune activation, if not well controlled. Therefore, we've also introduced the Regulator Dial gene circuit to solve this particular challenge by enabling very tight control of that specific payload. In particular, our Regulator Dial will be used to control the expression of IL-12 using an FDA-approved small molecule drug.

[SLIDE 28]

This slide shows the SENTI-301 product schematic.

SENTI-301 is an allogeneic off-the-shelf CAR-NK cell that's engineered to express a GPC3 CAR, which targets a liver cancer antigen called GPC3 or glypican 3. This has been a target that is clinically validated.

SENTI-301 also secretes the proprietary calibrated release IL-15 molecule to try to promote CAR-NK persistence and activity. Whereas the secreted paracrine IL-15 as part of this approach can also stimulate surrounding cells in the tumor microenvironment.

Finally, we're also arming CAR-NK cells with a highly potent cytokine IL-12, controlled by the Regulator Dial gene circuit.

[SLIDE 29]

These Multi-Arming features allow us to attack liver cancer in multiple complementary ways from the context of a single cell therapy.

On the left-hand side, we've optimized a GPC3 CAR to kill liver cancer cells very effectively. GPC3 happens to be a target that is not expressed very much in healthy adult human tissues, and therefore makes it a good tumor antigen to address on its own. This has been validated by previous clinical studies by other groups.

In the middle, our calibrated release IL-15 can stimulate the NK cells themselves as well as surrounding cells in the tumor microenvironment. In a similar fashion, IL-12, which is regulated in terms of secretion by the SENTI-301 Regulator Dial, can also stimulate a multi-factorial attack on tumor cells, including other immune cells in the tumor microenvironment.

[SLIDE 30]

I'd like to take some time to highlight 3 relevant pieces of data.

On the left-hand side, we've shown that our CAR-NK cells containing a GPC3 CAR, along with the calibrated release IL-15, achieve good effective killing of GPC3 positive cancer cells compared to the controls.

In the middle, we are presenting several pieces of data looking at the calibrated release IL-15. The flow cytometry graph on the left shows a significant amount of IL-15 detectable on the cell surface. On the right-hand side, we can also detect pretty high levels of IL-15 being secreted into the surrounding environment. The level that we are able to detect in terms of secretion is actually comparable or higher than what's been previously reported in other clinical studies that solely rely on wild-type, secreted IL-15. Therefore, we believe that with this calibrated release technology we can achieve the best of both worlds in terms of autocrine signaling through IL-15 on the cell surface as well as highly efficient signaling on the paracrine level through secreted IL-15.

On the right-hand side, I am showing additional data regarding the Regulator Dial gene circuit used to control IL-12 secretion. This is a more in-depth graph that builds on the data I showed you earlier, which shows a dose response in response to the molecule Grazoprevir on the X axis. The Cmin and Cmax, which are the dashed vertical lines on this graph, indicate what's been achievable in the past in humans when dosing with Grazoprevir.

Therefore, based on these optimized Regulator Dial constructs we've designed, we are well within the scope of being able to dose patients with different concentrations of drug and to be able to switch on the secretion of IL-12 by multiple orders of magnitude.

Thank you for your attention. I'll now pass it to Philip, our CTO, to discuss Senti's CAR-NK manufacturing strategy.

[SLIDE 31]

Philip Lee:

Thanks, Tim. So one of the key learnings in the cell and gene therapy field is that given the complexity of manufacturing, the ability to optimize and own the process is critical to long-term success.

Based on the extensive product opportunities that Tim described, we have established a highly efficient and scalable process for allogeneic CAR-NK cell manufacturing.

So starting on the left, under column one, we are isolating NK cells from healthy donor blood. This process enables the collection of hundreds of millions of NK cells per collection, which can be frozen and stored for use in multiple manufacturing batches, providing up to thousands of CAR-NK doses per donor.

In column two, we utilize a proprietary viral vector process to efficiently gene modify the NK cells with our gene circuit components.

In column three, the engineered cells are then expanded thousands of fold in bioreactors to generate over 100 doses per batch, which are stored frozen for clinical use, as shown in column four.

And as depicted on the right side of the slide, the key benefit of allogeneic NK cells is they do not depend on patient-derived cells and thus can be delivered off-the-shelf to the clinic, which significantly broadens patient access as well as product quality.

[SLIDE 32]

Our manufacturing strategy is illustrated on this slide.

From an early stage, we've established development capabilities in manufacturing and technical operations by hiring teams with deep expertise in cell and gene therapy. These are set up in our custom development facilities in South San Francisco, depicted in the lower right here.

Given the multiple product opportunities and the value of innovative manufacturing in a rapidly evolving field, our strategy is to invest in proprietary manufacturing as depicted in the center and right column of the figure on the left. We have initiated construction on a 92,000 square foot clinical GMP facility to support our lead CAR-NK programs into the clinic, with completion planned for 2022.

This facility also has the capacity to support future pivotal and commercial manufacturing to accelerate product development when clinical proof of concept is achieved. As depicted in the picture on the upper right, after an extensive search, we strategically selected our Alameda site to maximize access to talent and plug into the local biomanufacturing ecosystem.

The close proximity and collaboration between the development and manufacturing sites enables us to stay at the forefront of innovative technology.

[SLIDE 33]

Our manufacturing capabilities and proposed GMP facility could further enable us to expand our proprietary synthetic biology platform through a partnership in the biomanufacturing space. As Tim described, Senti's core vertical is to apply its gene circuit IP and manufacturing facility for therapeutic product development and commercialization.

The same IP and facility can also be applied to noncompetitive biomanufacturing applications, which we believe is an approach well-suited for partnering. Such a deal could involve Senti retaining operational control and manufacturing supply of our therapeutic candidates, while the partner could control part of the facility for its use.

A manufacturing partnership could allow Senti to expand the reach of its gene circuit technology into additional exciting commercial areas. There is, of course, no manufacturing partnership in place today, and Senti could determine to move its manufacturing plans forward without a partner.

[SLIDE 34]

Tim Lu:

As we've discussed today, our allogeneic CAR-NK cells have major benefits over existing programs for liquid and solid tumors. And this is really due to the Gene Circuit technology platform that I described earlier. This includes the potential for off-the-shelf administration of CAR-NK cells, thus enabling broad patient accessibility. It includes our

calibrated release platform technology, which allows us to engineer cytokines that have efficient autocrine and paracrine signaling for enhanced cellular activity. It includes our Logic Gates that allow us to achieve more precise and broader tumor targeting. It includes our Multi-Arming platform to achieve a combinatorial attack on cancer, and our Regulator Dials to achieve improved control.

We are very excited about our vast opportunities in allogeneic CAR-NK cells and oncology. However, our Gene Circuits are not just limited to these applications. Indeed they are generalizable across other cell and gene therapy modalities as well as other diseases. So to realize this broader potential, we've executed collaborations with other world leaders in the cell and gene therapy space.

[SLIDE 35]

For example, we kicked off a collaboration with Spark/Roche this year to apply our Smart Sensors to precision gene therapy. One of the key challenges with current AAV products is how to achieve precise targeting of diseased cells. Senti can solve this key challenge by designing highly specific promoters that detect disease biomarkers in specific on-target cell types using our Smart Sensor platform.

In this collaboration, we are applying this platform to the eye, the liver and the brain, with three key criteria: high on-target cell activity, low off-target cell activity and compact promoter size to enable packaging within the limited space of AAV.

This collaboration has allowed us to deepen our database of Smart Sensors, and further enhance our design-build-test-learn engine. And it just highlights just the surface of what's possible with the Senti platform in gene therapy and beyond.

[SLIDE 36]

In addition, we kicked off a collaboration with BlueRock/Bayer to expand our Gene Circuit platform into regenerative medicine.

The key challenges that we're trying to overcome are shown here, including the need for selective activation or control of stem-cell-derived cell therapies that will be implanted into the patients for a wide range of disease conditions. Therefore, we are designing disease-specific Smart Sensors that can control when and where the therapeutic is active after they have been delivered into the body. We are also designing Regulator Dials that enable small-molecule control over the functionality of those cells, or the secretion of payloads from those cells in the body itself.

We're very excited about our allogeneic CAR-NK programs for oncology, and also very appreciative for our great collaborators in areas outside of oncology. These programs are all based off of our powerful Gene Circuit platform.

Now let me turn it over to Deb Knobelman, our CFO, to tell you more about our upcoming milestones powered by our Gene Circuits.

[SLIDE 37]

Deb Knobelman:

Thanks, Tim.

This transaction could bring significant cash runway to Senti and allow us to achieve some critical value inflection points.

Most notably, this funding would support the filing of three INDs, for SENTI-301, SENTI-202 and SENTI-401, allow us to present clinical proof-of-concept data on two of those programs, and have one other program in the clinic. It will also allow us to deepen our discovery pipeline so that we can file one additional IND each year in 2024 and beyond.

At the same time, we will complete construction of the clinical-scale side of our GMP manufacturing facility with a portion of these funds.

[SLIDE 38]

Looking in the near term, in 2021, we've made substantial progress, including making significant scientific progress, internalizing GMP manufacturing, and completing two strategic collaborations with big pharma.

In the near future, we expect to hit several other significant milestones. Specific to SENTI-301 and -202, we will present IND-enabling data at key scientific conferences, as well as clinical-scale GMP manufacturing process data. We expect to continue to build out our pipeline in 2022 and will initiate preclinical work on additional CAR-NK products.

2022 is also when we will complete construction of our clinical-scale GMP facility to further the progress of SENTI-301 and SENTI-202 towards IND filings. And we anticipate IND filings for both products in 2023. With both near-term catalysts and key long-term value drivers from the funding of this deal, we believe we are well-positioned to provide a lot of upside to investors in Senti.

Back to Tim.

[SLIDE 39]

Tim Lu:

Thank you Deb.

Senti is very proud of our world-class management team, including our leading executives who have many years of experience at other major biopharma companies and institutions.

This includes Philip Lee, our Chief Technology Officer and co-founder. Philip and I were classmates at MIT over 20 years ago and have long shared the vision of applying biological engineering to advanced therapies. Philip received his PhD in Bioengineering from UC Berkeley and UCSF and founded a leading cell technologies company called CellASIC, which was ultimately acquired by Merck KGaA, where he led the cell culture systems franchise.

Curt Herberts is our Chief Operating Officer. Curt was previously Chief Business Officer at Sangamo Therapeutics, where he executed multiple major business development collaborations with big pharma across a diverse set of disease indications.

Deb Knobleman is our Chief Financial Officer. Deb is a scientist by training with a PhD in neuropharmacology from UPenn. She was previously a sell-side analyst at JPMorgan and Piper Jaffray and has been a C-suite executive at multiple life science companies, including positions as CBO of Ampio Pharmaceuticals and CFO of GeneriCo Pharma. She's executed public and private fundraises, corporate and business development, and built out finance organizations.

Jose Iglesias is our Chief Medical Advisor. Jose has over 25 years of drug development experience in oncology, including as Chief Medical Officer at Abraxis and clinical development roles at Celgene, Amgen, and Eli Lilly.

In addition, we have a board of directors that has deep experience across biotech and tech investing, financial operations, and drug development. Our scientific advisors are pioneers in synthetic biology, having published many of the seminal papers in the field, as well as industry experts with tremendous expertise in clinical drug development and advancing novel modalities to patients.

I am very grateful for the investors that have continued to support us along our journey to date as well as our new investors. I couldn't personally be more excited about leading this company into the next phase of growth with this transaction.

And we're very excited about the synergy between the Senti and Dynamics team together to advance our vision of intelligent medicine to patients. With that, I'll turn it over to the Dynamics team.

[SLIDE 40]

Mostafa Ronaghi:

Hello, my name is Mostafa Ronaghi, and I serve as Dynamics' CEO and director. As Omid mentioned, on behalf of our entire team, including our board of directors and chief science advisor, we are excited to be partnering with Senti and helping them to build a world-class company in the years to come.

I have a deep technological background and have been a serial investor, technology developer, and operator over the last two-and-a-half decades and throughout that period have developed an extensive network within the venture capital, emerging company, and strategic universe. I was most recently CTO of Illumina from 2008 to 2021, where I co-founded Grail and the Illumina Accelerator Program.

As you know, Omid serves as executive chair. Similar to Tim, he was a physician scientist and also a former professor at Harvard. Omid is a serial entrepreneur, including founding Seer, a public proteomics company where he serves as CEO and chair, and multiple other companies. Mark Afrasiabi serves as our CFO, and he was a senior partner at Silver Rock, where he covered health care for over a decade. Rowan Chapman serves as our Chief Business Officer and has a long career in venture capital

and business development, including J&J and GE. David Epstein, Jay Flatley and Deep Nishar serve on our board at Dynamics and Bob Langer is our chief scientific advisor.

These folks really need no introduction to folks in the life sciences world. And as you know, Bob, who has co-founded more than 40 companies including Moderna. Both Omid and Tim spent time in his lab.

[SLIDE 41]

Here are the transaction terms.

Given the disruptive potential of this platform in both cell and gene therapy, we believe this is a compelling entry point. The transaction is expected to close during Q2 of 2022, and as the Senti team described, the plan is to have two INDs in 2023 and then plan for one IND per year thereafter. We expect the transaction to deliver over \$290M of gross proceeds, inclusive of over \$150M of fully committed capital from our PIPE and existing shareholder non-redemption agreements to fund Senti's growth.

Now, let me turn it back to Tim for closing remarks.

[SLIDE 42]

Tim Lu:

Today, we shared with you our vision of engineering gene circuits to bring intelligent cell and gene therapies to patients. To make this a reality, we've built a world-leading team and powerful technology platform that integrates synthetic biology, computation and data together. The reason why we're so passionate about this vision is that existing cell and gene therapies are unable to address the majority of clinical needs due to their lack of genetic sophistication.

Our Gene Circuits platform addresses these problems directly through Logic Gating, Multi-Arming, Regulator Dial, and Smart Sensors. We've built a deep pipeline of Gene-Circuit-enhanced allogeneic CAR-NK cells, with the fully integrated ability to take these programs forward into manufacturing and ultimately into the clinic. Our CAR-NK programs are highly differentiated and potentially able to treat diseases that have currently few or no other options.

We've established key collaborations with global leaders in the cell and gene therapy space, demonstrating the broad potential of our platform. And we certainly believe that the field is poised to continue growing in this direction.

Following the combination with Dynamics, we expect to be very well-positioned to drive towards being a clinical-stage platform company that can deliver multiple intelligent cell and gene therapies to patients.

With that, thank you very much for your time and we very much appreciate the interest in Senti's Gene Circuit platform and therapeutic pipeline.